

Location of facilities in the design of the global logistics hub network taking into account the time discount coefficient

Reza, Karimi Mehrabadi¹. Emad, Roghanian^{2*}. Shahnaz, Piroozfar¹. Abbas, Shojaie¹

Received: 02 Feb 2022/ Accepted: 29 June 2022/ Published online: 01 Jan 2022

*Corresponding Author, e_roghanian@kntu.ac.ir

1- Department of Industrial Engineering, South Tehran Branch, Islamic Azad University, Tehran, Iran.

2 -Department of Industrial Engineering, K. N. Toosi University of Technology, Tehran, Iran.

Abstract

In this research, the problem of designing a logistics hub network to improve flow management in the implementation of global transport operations has been investigated. In this case, shipments can be moved directly or indirectly between points. In indirect shipping mode, the shipment first enters the hub network and then is sent to customers. In this case, there is a certain discount factor that reduces the time it takes for the product to reach end customers. The objective function of the proposed model is to minimize the fixed costs of constructing a hub, the cost of constructing an inter-hub infrastructure, the cost of transportation if the equipment is transported directly, and the cost of transportation if the hub network is used. The limitations of the model also include locating logistics hubs, managing flow between points, calculating transport time, and finally managing flow between network points. To evaluate the performance of the proposed model, a researcher-made numerical example based on real-world conditions with randomly generated data and sensitivity analysis on the problem outputs was performed. According to the results, it can be seen that the proposed model can produce justified and optimal global answers and therefore can solve real-world problems. Also, based on the sensitivity analysis, it can be seen that with increasing the amount of capacity, the values of the target function decrease. In other words, if capacity is increased, there is a need for fewer vehicles and thus costs are reduced. It is also clear that as capacity increases, the number of vehicles to respond to decreases. In fact, the greater the carrying capacity, the easier it is to manage the flow between the hubs as well as the direct transmission, thus reducing the number of vehicles. In addition, as the cost of building infrastructure increases/decreases, the cost of the entire system is affected.

Keywords- Location, global logistics; hub network design; time discount coefficient

INTRODUCTION

But looking at the functional issues in the supply chain literature and exploring the results of operational projects, it can be seen that logistics network integration is a new concern for some global organizations on various issues such as humanitarian logistics. Is commercial logistics and tourism logistics (Song & Parola, 2015). For example, we can refer to the planning done by the United Nations Humanitarian Response Depot (UNHRD), which always tries to create a global network to optimally meet the needs in times of crisis in different parts of the world (Dufour, Laporte, Paquette, & Rancourt, 2018). For example, the global freight network being designed by companies such as Amazon has recently been recognized as one of the largest global trade projects (Robischon, 2017). The company intends to be able to respond to any demand anywhere in the world in

the shortest possible time. But it currently covers only part of Europe, Southeast Asia, and North America. In the tourism sector, we can also mention the operational projects implemented by some large tourism companies such as Expedia Group or studies conducted to develop the Antalya tourism cluster as a global tourism center. Studies to develop a logistics system in Thai tourism management are other examples of studies in this field (Somnuek, 2017). Therefore, it can be said that the existence of integrated logistics structures, in addition to reducing strategic and operational costs, can improve political relations between communities (Bhatnagar & Viswanathan, 2000), which is itself a prelude to the expansion of international relations. For all countries, especially underdeveloped countries; because some underdeveloped countries have very good logistical potentials, but due to the impossibility of investment, it has not been able to achieve its main position in world trade (Vasiliauskas & Jakubauskas, 2007). The African continent, for example, has some of the most important commercial ports in the world.

However, the continent is in a critical situation in terms of transportation infrastructure (Tchamyou, 2017).

In some previous studies, the issue of global logistics network design has been discussed as a conceptual issue that mainly defines development strategies in various political and financial areas, identifies and measures the development criteria of these networks. They also provided management solutions to implement the results (Zijm, Klumpp, Heragu, & Regattieri, 2019). Therefore, it can be said that there is enough access to infrastructure models and analytical studies. But the issue that has received less attention is the optimal design of the global logistics network to integrate strategic decisions such as the location of facilities and the infrastructure for the development of ports and airports and operational guarantees such as the coordination of maritime and air transport. And is grounded in real-world conditions through mathematical optimization tools and big data analysis methods. However, these tools are among the most efficient management tools available to achieve highly reliable answers (Prinzie & Van den Poel, 2005). According to studies, most of the logistics structures presented in previous studies are limited to locating facilities and pay much attention to other aspects of logistics management, such as the coordination of transport systems for scheduling by sea, air, and land. Also, inventory management in warehouses of goods has not been done (Mangan & Lalwani, 2016). However, designing an integrated facility location structure, synchronizing different vehicles, and inventory management can improve logistics system performance and ultimately reduce operating costs (Vanajakumari, Kumar, & Gupta, 2016).

In general, three approaches including 1) capacity expansion, 2) demand distribution and 3) equipment management in order to deal with disorders caused by the lack of goods for customers around the world. Applying each of the approaches depends on the creation of a reliable logistics infrastructure. The capacity expansion approach directly emphasizes the creation of new demand-side infrastructure as well as the provision of new equipment, which of course requires a lot of time and money. In this approach, it is believed that all the necessary equipment and facilities should be provided to meet the demand in each region and budget constraints should not be considered. However, there was not enough time to build such infrastructure in the global logistic networks. In addition, many countries around the world faced new financial problems that limited the possibility of building facilities or purchasing new equipment. Therefore, this approach cannot be considered as a rapid response tool in the global supply chains. The focus of the demand distribution approach is on the transfer of applicants of global services to different centers so that the empty capacity of all existing centers in an area can be used.

In this research, the issue of flow management in global logistics is examined as a hub network design issue. The use of global hubs, in addition to significantly reducing costs, can also lead to a reduction in service delivery time. Creating order integration channels and transport management through highways created between hubs reduces transportation operating costs and ultimately leads to near-optimal conditions. In addition, considering the time discount coefficient in intercity transportation compared to direct transportation has made the problem environment closer to the real-world situation; This is because there are a variety of examples in which consolidating shipments and shipping management can reduce operating costs. The limitations of the model also include locating logistics hubs, managing flow between points, calculating transport time, and finally managing flow between network points. In the following, first, the research literature is examined and then the research problem and mathematical model are explained. In the fourth section, the numerical results are described so that in the final part of the research, a summary and future proposal for the development of theoretical and operational dimensions of the research can be presented.

REVIEWING RESEARCH LITERATURE

In this section, articles related to the field of research are reviewed, which are mainly published in 2020 and 2021. To this end, we can refer to the research presented by (Yamaguchi, Shibasaki, Samizo, & Ushirooka, 2021) that focuses on container transport in Myanmar, predicts the possibility of the rapid growth of the country's economic indicators. In the future. This study simulates the impact of Myanmar logistics policies on container transport. These measures include improving the east-west corridor of the Greater Mekong area and the development of the southern corridor and the port of Dawi. Based on the simulation

results, the authors conclude that policies that reduce border barriers and improve service levels at the port of Dawi will also lead to Thailand using Myanmar ports for its cargo. (Shah, Rutherford, & Menon, 2020) presented research to summarize the current and potential capabilities of the Internet of Things how it will help logistics management and how to further help in the 2050 digital age. The IoT is expected to take over the way logistics operations are managed today, reducing the number of employees in many organizations around the world. (Jiang, Zhang, Meng, & Liu, 2020) designed a multi-purpose local logistics network to reduce CO₂ emissions and uncertain demands for urban cluster development. The system studied in this paper is formulated as a two-tier programming model followed by equivalent mathematical programming with equilibrium constraints to depict leader-follower behaviors. (Guerrero, 2020) in his research modeling and policy setting for the global logistics network, quantification, and analysis for international transport. Initially, the main determinants of the evolution of regions within Europe were examined through a literary study. This explores the opportunities and challenges of interregional comparisons and proposes a common pilot framework.

(Lu, Zhu, Wang, Xie, & Su, 2020) optimally designed a hybrid recycling network that simultaneously integrates forward and reverse logistics between its multi-product multi-story structures. To optimize this problem, a fuzzy mixed-integer is modeled using the linear programming approach. (Trochu, Chaabane, & Ouhimmou, 2020) presented a two-stage stochastic model for designing an efficient reverse logistics network with environmental considerations. The purpose of this optimization model is to maximize the expected profit and minimize waste disposal activities to create more incentives to recycle materials. (Sadriani, Langarudi, & payandeh Sani, 2020) proposed a framework for reusing household appliances to reduce municipal solid waste and help low-income families. To optimize the reverse logistics network, a single-objective mixed-integer linear programming model with uncertainty in the number of products used by consumers is proposed. (Guerrero-Lorente, Gabor, & Ponce-Cueto, 2020) presented an integrated integer scheduling model for the Omnichannel logistics network design problem with integrated customer priority for delivery and efficiency that manages online orders from retailers. The network includes a variety of facilities, such as city distribution centers, intermediate warehouses, packing offices, as well as channel points such as auto packing points, shops, or kiosks.

(Y. Wang et al., 2020) formulated and solved a multi-location logistics network design problem involving the routing of vehicles with multiple shared warehouses by allocating a time window to effectively reduce the impact of changing time windows on operating costs. In this paper, a dual-objective planning model is developed that optimizes the total operating cost and the total number of delivery vehicles. An innovative hybrid algorithm consisting of K-means clustering, Clark-Wright saving algorithm (CW), and extensive non-dominant sorting genetic algorithm (E-NSGA-II) is proposed to solve this problem efficiently. (Tosarkani, Amin, & Zolfagharinia, 2020) to develop a scenario-based feasibility approach based on optimization and configuration of an inverse electronic logistics network taking into account uncertainties related to fixed and variable costs, demand and efficiency, and product quality. They returned. Table 1 summarizes the research related to the field of research.

According to a review of the research literature, it can be seen that most of the researchers in this field used mathematical optimization tools to solve the problem, which confirms the high efficiency of using optimization methods in solving real-world problems. In addition, in most studies, the location of facilities has been the main focus, which is a major part of strategic decisions. But in the meantime, other key issues such as the use of combined transport, including the possibility of direct sending and sending through the hub network, have been less studied. In the real world, however, many companies use this feature in their hub networks. It should also be noted that much of the research in the field of logistics is inverted and classical, and less attention has been paid to the design of the global logistics network. While one of the most important criteria for sustainable global development is to pay attention to the improvement of global logistics structures; because it clearly improves the quality of communication and ultimately increases productivity in supply and demand management. Therefore, it can be said that this research tries to cover some of the neglected points in the research literature and is the basis for future research in the development of global logistics.

Based on the literature review, the most important novelties of this research which cover the research gaps are as follow:

- ✓ Designing a new global hub network problem using mathematical programming.
- ✓ Considering a hybrid transportation type including 1) direct shipping and 2) undirected shipping using hub network.
- ✓ Considering time discount coefficient parameter which made the problem environment closer to the real-world situation
- ✓ Considering a hard time window to improve the reality of the problem based on the customers satisfaction.

TABLE 1
SUMMARY OF RESEARCH RELATED TO THE FIELD OF RESEARCH

Author(s)	Study of logistics network understudy				Review approach		Network structure			
	Classical logistics	Reverse logistics	Regional logistics	Global logistics	simulation	Mathematical programming	Location	Flow management	Routing	Combined shipping
(Liao, 2018)		*				*	*			
(John, Sridharan, & Kumar, 2018)		*				*	*			
John, Sridharan, Kumar, &) (Krishnamoorthy, 2018)		*				*	*			
(Cheng, Qi, Zhang, & Rousseau, 2018)	*				*	*	*			
(Rahimi & Ghezavati, 2018)		*				*		*		
(Jiang, Zhang, Li, & Liu, 2019)	*					*		*		
(Reddy, Kumar, & Ballantyne, 2019)		*				*	*			
Zarbakhshnia, Soleimani, Goh, &) (Razavi, 2019)	*	*				*	*			
(Gao, 2019)		*				*		*		
Yuchi, Wang, Li, Yang, & Jiang,) (2019)		*				*	*			
Trochu, Chaabane, & Ouhimmou,) (2019)		*				*		*		
(Z. Wang, Huang, & He, 2019)		*				*	*			
Oyola-Cervantes & Amaya-Mier,) (2019)		*				*	*			
(Kuşakcı, Ayvaz, Cin, & Aydın, 2019)		*				*			*	
(Kwag & Ko, 2019)	*					*	*			
(Aljuneidi & Bulgak, 2019)		*				*	*			
(Ohmori & Yoshimoto, 2019)				*		*	*			
(Jiang et al., 2020)			*			*				*
(Lu et al., 2020)		*				*			*	
(Trochu et al., 2020)		*				*		*		
(Yu, Sun, Solvang, & Zhao, 2020)		*				*	*			
(Sadrnia et al., 2020)		*				*			*	
(Guerrero-Lorente et al., 2020)	*					*	*			
(Y. Wang et al., 2020)	*					*	*			
(Tosarkani et al., 2020)		*				*			*	
(Mishra & Singh, 2020)		*				*	*			
(Park, Kim, Ko, & Song, 2020)		*				*	*			
(Yan, Wen, Teo, Liu, & Xu, 2020)			*			*				*
(Budak, 2020)		*				*	*			
(Liu, Cao, Liang, & Chen, 2020)	*					*	*			
(Yamaguchi et al., 2021)				*	*	*	*			
(Li, L., & Liu, Z. P., 2022)				*		*	*	*		
(Falcone, E. C., Fugate, B. S., & Dobrzykowski, D. D., 2022).	*					*	*	*		*
(Lavassani, K. M., Movahedi, B., & Iyengar, R. J., 2022)	*			*		*	*	*	*	
(Kim, Y. G., & Do Chung, B., 2022)	*	*				*	*	*	*	*
The present study				*		*	*	*		*

EXPLAINING THE RESEARCH PROBLEM AND MATHEMATICAL MODEL

In this research, the issue of flow management in the global hub network has been investigated to reduce the delay time in receiving customer demand in the form of a mathematical optimization model. It should be noted that in the global logistics structure, it is not possible to send goods directly from supply centers to consumption points, or if this is possible in terms of

infrastructure, it will certainly not be economical. In addition, the time of direct delivery of goods from the source of supply to the final destination may be so long that it practically destroys the operation of the logistics system. To this end, it is desirable that in some areas (preferably global metropolises with different transport infrastructure and also have sufficient capacity to store products) centers have been established as hubs to facilitate the delivery of goods. These centers are known as the main bases for receiving and sending goods. In addition, these hubs are known as the main centers, and the operations of sending, receiving, sorting, and distributing goods will take place in them. Customer regions in different locations will then be assigned to each hub uniquely. In this way, all executive operations such as sales market management, including demand forecasting, inventory management, cost management, and receipt and delivery management of goods to each region can be better examined. Figure 1 shows the supply structure of goods in the presence and absence of hubs in a logistics system.

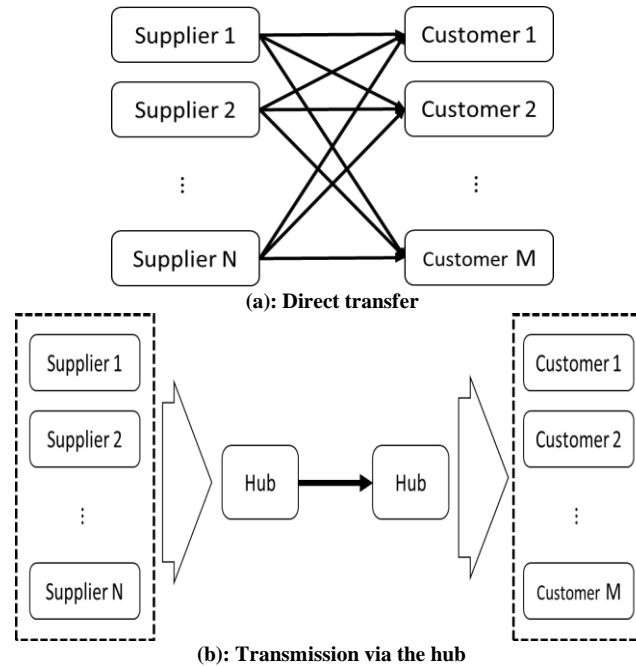
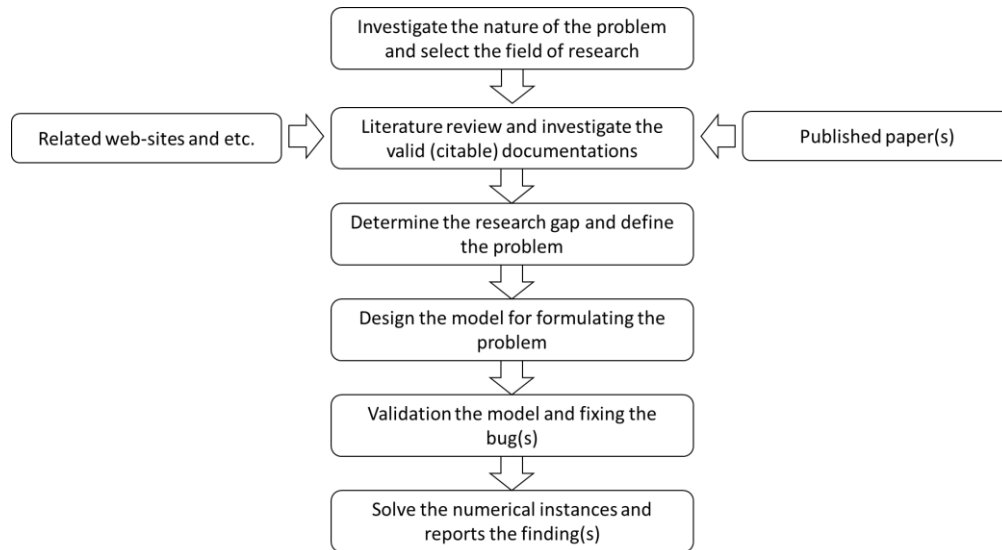

FIGURE 1

TYPES OF HUBS USED IN THE PROPOSED NETWORK STRUCTURE

As can be seen, direct transmission (Figure 1 (a)) is much more expensive than hub transmission (Figure 1 (b)). Therefore, the use of logistics hubs can greatly reduce costs and facilitate flow management between different levels of the chain. However, the management of this distribution flow requires careful studies, which in this study tries to provide an optimization model to minimize transmission costs according to the level of demand of each customer. But one of the main problems in implementing this plan is the high time and cost of transportation between different places. To solve this problem, in this study, the concept of creating a hub network has been used in which some parts of the country that have more appropriate technical and communication infrastructure are selected as hubs and demand flow management through communication networks. To be done between hubs. This will reduce both the cost and the supply time. Following figure shows the conceptual framework of the research.



Sets and Indexes

$\{i, j\} \in N$	A set of total network points
$\{k, l\} \in H$	A set of potential points for building a hub

Input parameters

FH_k	Fixed cost of building the necessary infrastructure at a potential point k as a hub
f_{ij}	Our products flow between two stations
\hat{C}_{ij}	Our shipping cost between two points in case of direct shipping
C_{ij}	The cost of our transportation between two points in normal transportation
HL_{kl}	The cost of an interconnected network connection
cap	Capacity of vehicles to transport products
CV	The cost of using vehicles
d_{kl}	The cost of unloading and loading our products between h and k's
tt_{ij}	Transport time between two points
ot_k	Operating time required in hub k
α	hub interval time discount coefficient
SB_{ij}	Equipment delivery time range between two points
M	One large enough number

Decision variables

H_k	If a point in a potential location k is selected as a hub, one; Otherwise zero
\hat{Y}_{ij}	If the transport between two points is done directly, one; Otherwise zero
Y_{ijkl}	If the transport between two points takes place through the hub link k and l, one; Otherwise zero
Z_{kl}	If a hub link is established between two hubs k and l, one; Otherwise zero
X_{ik}	If point i is assigned to hub k, one; Otherwise zero
num_{kl}	Number of vehicles required between hubs k and l
ICG_{kl}	The cost of moving goods between hubs k and l
TFM_{kl}	Number of shipments shipped between k and l hubs
ST_{ij}	Transport time of products between two points

$\begin{aligned} \text{Min} \sum_k FH_k H_k + \sum_{k:l:k \neq l} HL_{kl} Z_{kl} + \sum_{i,j} f_{ij} \hat{C}_{ij} \hat{Y}_{ij} + \sum_{i,j:i \neq j . k:l:k \neq l} (C_{ik} + C_{kj}) Y_{ijkl} f_{ij} + \sum_{k:l:k \neq l} ICG_{kl} \\ + \sum_{k:l:k \neq l} \left(\left(\sum_{i,j:i \neq j} f_{ij} Y_{ijkl} \right) (C_{kl} + d_{kl}) \right) \end{aligned}$	1
<p>Subject to:</p>	
$\sum_k X_{ik} = 1 \quad \forall i \in N$	2
$\sum_i X_{ik} \leq MH_k \quad \forall k \in H$	3
$\sum_{k \in H} X_{kk} = P$	4
$\sum_i X_{ik} \leq MX_{kk} \quad \forall k \in H$	5
$Z_{kl} \leq H_k \quad \forall k.l \in H : k \neq l$	6
$Z_{kl} \leq H_l \quad \forall k.l \in H : k \neq l$	7
$\sum_{l:l \neq k} Z_{kl} \geq 1 + M(X_{kk} - 1) \quad \forall k \in H$	8
$\sum_{k:l:k \neq l} Y_{ijkl} = 1 - \hat{Y}_{ij} \quad \forall i.j \in N : i \neq j$	9
$\sum_{l:l \neq k} Y_{ijkl} - \sum_{l:l \neq k} Y_{ijlk} = X_{ik} - X_{jk} \quad \forall i.j \in N : i \neq j . k \in H$	10
$Y_{ijkl} + Y_{ijlk} \leq Z_{kl} \quad \forall i.j \in N : i \neq j . k.l \in H : k \neq l$	11
$num_{kl} \geq \frac{TFM_{kl}}{cap} \quad \forall k.l \in H : k \neq l$	12
$ICG_{kl} = num_{kl} CV \quad \forall k.l \in H : k \neq l$	13
$TFM_{kl} = \sum_{i,j:i \neq j} f_{ij} Y_{ijkl} \quad \forall k.l \in H : k \neq l$	14
$ST_{ij} = \sum_{k:k \neq i} tt_{ik} X_{ik} + \sum_{k,l:l \neq i . t} (ot_k + \alpha tt_{ij} + ot_l) Y_{ijkl} + \sum_{k:k \neq j} tt_{kj} X_{kj} \\ + tt_{ij} \hat{Y}_{ij} \quad \forall i.j \in N : i \neq j$	15
$ST_{ij} \leq SB_{ij} \quad \forall i.j \in N : i \neq j$	16
$H_k \in \{0,1\} \quad \forall k \in H$	17
$X_{ik} \in \{0,1\} \quad \forall i \in N . k \in H$	18
$Z_{kl}^m \in \{0,1\} \quad \forall k.l \in H : k \neq l$	19
$Y_{ijkl} \in \{0,1\} \quad \forall i.j \in N : i \neq j . k.l \in H : k \neq l$	20
$\hat{Y}_{ij} \in \{0,1\} \quad \forall i.j \in N : i \neq j$	21
$TFG_{kl} \geq 0 \quad \forall k.l \in H : k \neq l$	22
$num_{kl} \geq 0 \quad \forall k.l \in H : k \neq l$	23
$ICG_{kl} \geq 0 \quad \forall k.l \in H : k \neq l$	24
$TFM_{kl} \geq 0 \quad \forall k.l \in H : k \neq l$	25
$ICM_{kl} \geq 0 \quad \forall k.l \in H : k \neq l$	26
$ST_{ij} \geq 0 \quad \forall i.j \in N : i \neq j$	27

The objective function of the model has six sentences in which; In the first part, the fixed cost of constructing a hub is calculated, in the second part, the cost of constructing an inter-Jewish infrastructure, in the third part, the cost of transportation in case of direct transportation of equipment, and in the fourth, fifth and sixth parts, the cost of transportation is calculated in case of

using a hub network. Constraint (2) states that any non-hub point can be assigned to only one hub. Constraints (3) and (4) establish a relationship between two types of facilitation variables. Constraint (5) indicates that a node can be assigned to a hub when the hub in question is constructed. The function of constraint (6) is that an inter-denominational connection can be established when both nodes are selected as hubs. Constraint (7) indicates that communication can be established by constructing two hubs at two points. Constraint (8) states that if one point is selected as a hub, it will be connected to another hub with an inter-hub connection. In constraint (9), we choose between direct and hub-based transportation methods. Constraint (10) is the constraint of our current balance between points. This limitation determines which interfaith connection is used to transport between the two points. Constraint (11) ensures that shipments flow only on hub links constructed. Constraint (12) determines the number of vehicles required and constraint (13) calculates the cost of interstate transportation. In constraint (14) the total amount of inter-Baha'i cargo is calculated. Constraint (15) calculates the total service time between two points and constraint (16) specifies the corresponding boundary. Limits (17) to (28) indicate the range of value of the decision variables.

COMPUTATIONAL RESULTS

Numerical results analysis includes coding, solving, and numerical analysis of the results of solving the proposed model, which makes it possible to provide management analysis to implement the results in real-world conditions. In this part of the research, the proposed model of the problem is solved with the help of a Cplex 12.1 solver in the GAMS 27 commercial software environment and the necessary numerical analyzes including analysis of the sensitivity of the model to change the input parameters are presented. But the numerical analysis must always be presented in a context based on real-world conditions. For this purpose, in this paper most of the parameters are generated based on the real data collected by authors from a research field process. It should be notice that some parameters are generated randomly that is a regular data generation method in the literature (Wang, etal, 2019). In this example, there are 10 points where points 1, 4, 6, 8, and 10 are considered as creating a hub. It is clear that these points play the role of consolidation centers for shipments.

TABLE 2
THE FIXED COST OF BUILDING INFRASTRUCTURE AT POTENTIAL AND HUB CONSTRUCTION SITES

Point 10	Point 8	Point 6	Point 4	Point 1
2877	2903	3651	4530	2515

TABLE 3
PRODUCT FLOW BETWEEN TWO POINTS

	Point 1	Point 2	Point 3	Point 4	Point 5	Point 6	Point 7	Point 8	Point 9	Point 10
Point 1	0	10	26	2	15	30	17	30	23	4
Point 2	19	0	8	20	13	11	11	4	5	18
Point 3	25	7	0	23	9	3	15	5	26	8
Point 4	9	18	22	0	14	12	4	9	1	10
Point 5	5	19	17	23	0	20	23	19	9	3
Point 6	3	19	16	1	24	0	5	16	23	5
Point 7	1	18	19	12	11	7	0	4	28	11
Point 8	24	9	4	22	2	6	0	0	15	5
Point 9	5	10	10	10	29	30	11	11	0	12
Point 10	27	4	22	2	17	2	0	12	16	0

TABLE 4
DIRECT SHIPPING COST BETWEEN TWO POINTS

	Point 1	Point 2	Point 3	Point 4	Point 5	Point 6	Point 7	Point 8	Point 9	Point 10
Point 1	0	419	383	346	581	427	340	416	412	381
Point 2	585	0	389	322	420	331	415	397	358	334
Point 3	479	453	0	535	584	479	482	409	478	504
Point 4	452	348	497	0	337	596	368	503	533	580
Point 5	360	389	359	374	0	520	326	345	430	356
Point 6	508	529	346	417	509	0	484	593	308	356
Point 7	326	462	338	520	334	447	0	448	460	303
Point 8	463	435	593	355	349	307	353	0	305	551
Point 9	480	308	359	585	401	478	378	492	0	438
Point 10	418	542	462	417	467	580	405	302	585	0

TABLE 5
THE COST OF TRANSPORTATION BETWEEN TWO POINTS IN NORMAL MODE (NETWORK USE)

	Point 1	Point 2	Point 3	Point 4	Point 5	Point 6	Point 7	Point 8	Point 9	Point 10
Point 1	0	8	7	5	8	7	5	7	6	8
Point 2	8	0	6	7	7	5	8	8	7	6
Point 3	6	5	0	7	7	7	7	5	8	7
Point 4	8	8	7	0	7	7	7	5	6	5
Point 5	7	6	6	7	0	7	7	5	6	7
Point 6	7	8	6	6	5	0	6	6	5	7
Point 7	6	5	6	6	8	5	0	6	6	7
Point 8	7	6	5	8	6	8	6	0	6	6
Point 9	6	5	7	7	5	6	6	8	0	7
Point 10	8	8	8	8	6	7	7	7	5	0

TABLE 6
COST OF CREATING A NETWORK BETWEEN HUBS

	Point 1	Point 4	Point 6	Point 8	Point 10
Point 1	0	937	832	866	863
Point 4	904	0	834	937	901
Point 6	915	944	0	804	968
Point 8	942	831	922	0	839
Point 10	873	925	946	883	0

TABLE 7
UNLOADING AND LOADING COSTS BETWEEN HUBS

	Point 1	Point 4	Point 6	Point 8	Point 10
Point 1	0	30	68	69	69
Point 4	64	0	32	52	37
Point 6	70	62	0	33	47
Point 8	44	35	53	0	46
Point 10	67	39	39	52	0

TABLE 8
COST OF MOVING BETWEEN HUBS

	Point 4	Point 6	Point 8	Point 10
Point 4	0	300	400	250
Point 6	200	0	250	150
Point 8	450	150	0	150
Point 10	250	150	250	0

TABLE 9
SHIPPING TIME BETWEEN POINTS

	Point 1	Point 2	Point 3	Point 4	Point 5	Point 6	Point 7	Point 8	Point 9	Point 10
Point 1	0	3	9	4	3	4	2	9	4	5
Point 2	4	0	8	7	3	3	5	7	4	2
Point 3	7	7	0	8	3	7	7	9	6	4
Point 4	6	5	3	0	5	3	7	2	8	9
Point 5	6	6	8	6	0	8	3	4	7	6
Point 6	10	10	9	5	6	·	9	3	7	8
Point 7	7	2	8	4	5	5	0	7	6	7
Point 8	10	5	8	10	10	4	5	0	3	8
Point 9	4	8	7	4	8	2	9	2	0	5
Point 10	8	5	6	5	8	9	6	4	6	0

TABLE 10
OPERATION TIME AT EACH HUB POINT

Point 10	Point 8	Point 6	Point 4	Point 1
1	2	2	1	3

TABLE 11
EQUIPMENT DELIVERY TIME RANGE BETWEEN TWO POINT

	Point 1	Point 2	Point 3	Point 4	Point 5	Point 6	Point 7	Point 8	Point 9	Point 10
Point 1	0	604	576	664	664	517	613	792	614	547
Point 2	642	0	562	688	501	651	501	656	751	522
Point 3	728	587	0	631	611	666	522	773	515	746
Point 4	738	698	618	0	760	793	672	594	637	611
Point 5	626	526	744	653	0	747	624	777	618	633
Point 6	709	703	671	552	681	0	718	574	543	767
Point 7	633	534	771	600	799	639	0	557	560	693
Point 8	740	676	791	647	612	748	746	0	778	501
Point 9	685	502	622	697	685	579	521	514	0	636
Point 10	551	671	758	511	607	601	646	578	767	0

It is noteworthy that the temporal discount coefficient (α) is equal to 0.206. Also, the capacity of vehicles to carry cargo (cap) is equal to 20 and the cost of using vehicles (CV) is equal to 50. After solving the problem, the graph of the reduction of the computational gap between the upper limit and the best response discovered in each section is shown in Figure 2.

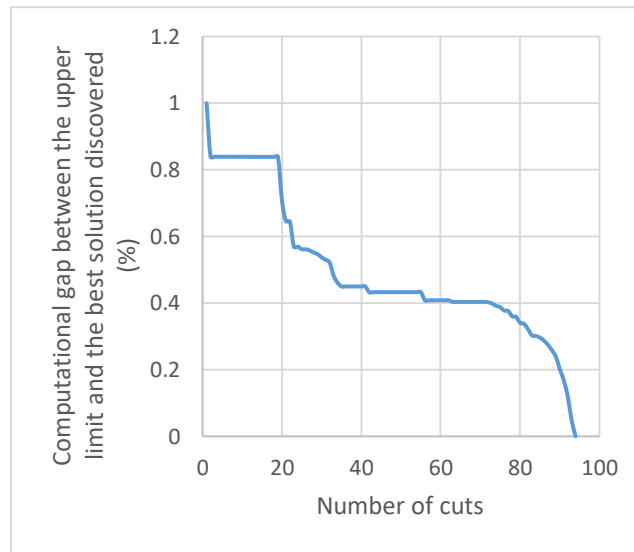

FIGURE 2

REDUCTION OF THE COMPUTATIONAL GAP BETWEEN THE UPPER LIMIT AND THE BEST RESPONSE DISCOVERED IN EACH SECTION

As can be seen, in the computational gap between 60 and 40%, the reduction process is very slow and a large number of cuts are required. This indicates the high complexity of the model in solving. After obtaining the optimal global answer that requires 1 minute and 35 seconds, the answers are presented in Table 12.

TABLE 12
SENTENCE VALUES OF OBJECTIVE FUNCTIONS

sixth sentence	Fifth sentence	fourth sentence	third sentence	second sentence	first sentence	the total value of the objective function
51646	2950	11262	53778	10734	13961	144331

Due to the volume of cargo flow between points, it is necessary to create a large number of hub centers. Therefore, the available hubs (H_k) include points 4, 6, 8, and 10. It is clear that in some places, transportation is done directly, which is presented in the table below.

TABLE 13
POINTS THAT HAVE DIRECT TRANSPORT BETWEEN EACH OTHER

	Point 1	Point 2	Point 3	Point 4	Point 5	Point 6	Point 7	Point 8	Point 9	Point 10
Point 1				✓						
Point 2			✓							
Point 3		✓								
Point 4	✓									
Point 5										✓
Point 6							✓			
Point 7										
Point 8		✓	✓							
Point 9	✓			✓						
Point 10					✓					

It is clear that the transport between other points was done using a hub network. Therefore, the flow between hubs will be presented below.

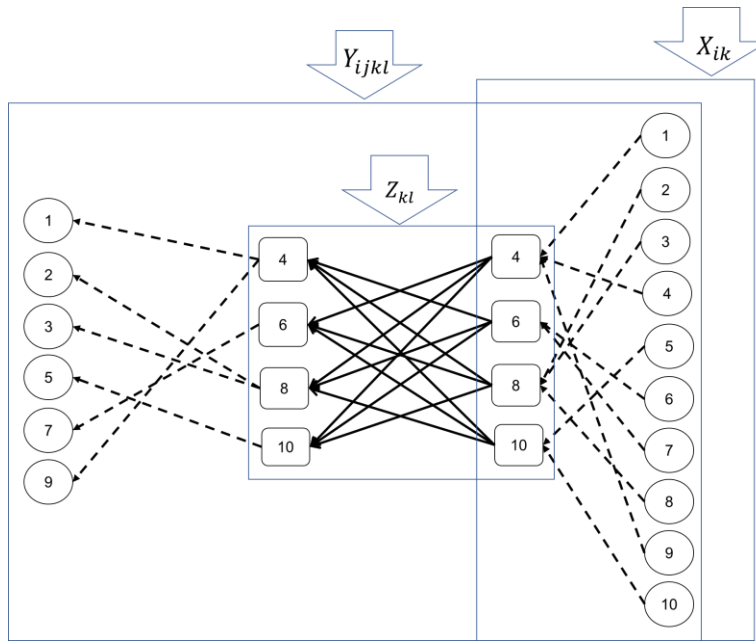

FIGURE 3
GRAPHIC STRUCTURE OF THE ANSWERS OBTAINED BY SOLVING A NUMERICAL EXAMPLE

The allocation of network points to the construction sites is also presented in Table 14.

TABLE 14
ASSIGNMENT OF POINTS TO CONSTRUCTED HUBS

Point 10	Point 9	Point 8	Point 7	Point 6	Point 5	Point 4	Point 3	Point 2	Point 1	
	1					1			1	Point (hub) 4
			1	1						Point (hub) 6
		1					1	1		Point (hub) 8
1					1					Point (hub) 10

As can be seen, according to constraint (2) in the mathematical model, each point is assigned to only one hub. Also, according to constraint (5), each point is allocated to the hub created at the same point. The values of the Z_{kl} variable are as follows.

TABLE 15
THE STRUCTURE CREATED FOR THE INTER HUB NETWORK

Point (hub) 10	Point (hub) 8	Point (hub) 6	Point (hub) 4	
1	1	1	0	Point (hub) 4
1	1	0	1	Point (hub) 6
1	0	1	1	Point (hub) 8
0	1	1	1	Point (hub) 10

The number of vehicles required between the two points is as follows.

TABLE 16
NUMBER OF VEHICLES REQUIRED num_{kl}

	Point 4	Point 6	Point 8	Point 10
Point 4	0	6	8	5
Point 6	4	0	5	3
Point 8	9	3	0	3
Point 10	5	3	5	0

Other information related to the cost of moving between hubs, the total number of shipments shipped between hubs, and finally the shipping time between hubs is as follows.

TABLE 17

TOTAL NUMBER OF SHIPMENTS TRANSPORTED BETWEEN HUBS TFM_{kl}

	Point 4	Point 6	Point 8	Point 10
Point 4	0	104	146	84
Point 6	68	0	92	51
Point 8	179	46	0	55
Point 10	82	45	93	0

TABLE 18

TRANSPORT TIME BETWEEN TWO POINTS (ST_{ij})

	Point 1	Point 2	Point 3	Point 4	Point 5	Point 6	Point 7	Point 8	Point 9	Point 10
Point 1	0	93.355	121.064	0	88.355	99.473	93.236	117.064	0	101.591
Point 2	101.473	0	0	115.827	91.355	98.355	108.591	0	103.473	92.236
Point 3	115.827	0	0	121.945	93.355	116.827	118.827	0	113.709	102.473
Point 4	0	105.591	100.355		100.591	99.355	117.827	92.236	0	122.064
Point 5	102.709	101.709	112.945	104.709		111.945	93.355	92.473	108.827	0
Point 6	126.182	125.182	124.064	107.591	103.709	0	0	95.355	115.827	116.945
Point 7	111.827	90.236	117.945	101.473	97.591	0	0	109.827	109.709	110.827
Point 8	123.182	0	0	125.182	117.182	99.473	105.591	0	96.355	113.945
Point 9	0	113.945	112.827	0	108.945	91.236	122.064	88.236	0	101.591
Point 10	115.945	102.591	109.709	105.591	0	121.064	110.709	97.473	109.709	0

As can be seen, the resulting answers are quite justified and therefore it can be said that the performance of the proposed model is correct.

- *Sensitivity analysis*

In this section, to investigate the behavior of the model under the influence of changes in input parameters, numerical analysis is performed. For this purpose, three important parameters in the mathematical model that are predicted to have the greatest impact on the final results are selected and then the changes in the values of these parameters in different conditions are examined. It is noteworthy that the results of changing the above parameters on the values of different sentences of the objective function, the number of hubs created, the number of vehicles used, and also the number of routes in the hub network will be examined.

- Analysis of changes in vehicle carrying capacity (Cap)

Considering the final goal of this study, which is to develop the use of hub-based structures to facilitate flow management on the country's railways, considering the capacity of cargo transportation on inter-hub routes can have an effective effect on the final results. Be. Therefore, in this section, this capacity level is changed in ten different modes and the results are described as follows.

TABLE 19
THE EFFECT OF CAPACITY CHANGES ON THE VALUES OF OBJECTIVE FUNCTION SENTENCES

Capacity	the total value of the objective function	first sentence	second sentence	Third sentence	fourth sentence	Fifth sentence	sixth sentence
Cap=50	122933	11629	8940	44793	11237	2433	43901
Cap=45	125806	12113	9216	45707	11466	2508	44796
Cap=40	129100	12487	9404	47120	11820	2559	45710
Cap=35	133047	13007	9898	48577	12312	2611	46642
Cap=30	136751	13272	10100	50079	12959	2748	47593
Cap=25	140870	13682	10412	51627	13223	2862	49064
Cap=20	146561	13961	10734	53778	13492	2950	51646
Cap=15	169380	15916	12881	60232	15381	3511	61459
Cap=10	192553	17986	15071	69870	17842	4179	67605

As can be seen, as the capacity increases, so does the number of target function journals. Of course, this is exactly true; This is because if the capacity is increased, the number of vehicles will be needed less and therefore the costs will be reduced.

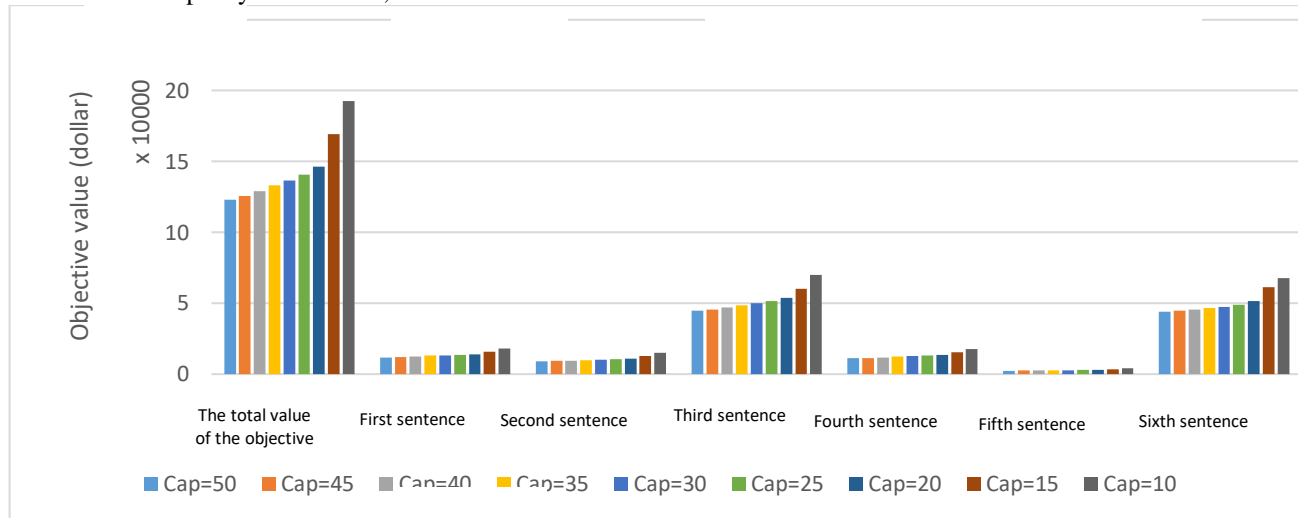

FIGURE 4
SENSITIVITY OF OBJECTIVE FUNCTION SENTENCE VALUES TO CAPACITY CHANGE

Regarding the total number of vehicles used in case of a change of capacity, you can also refer to the information in the table below.

TABLE 20
CHANGES IN THE NUMBER OF VEHICLES (num_k) VERSUS CHANGES IN THE CAPACITY LEVEL

Capacity	Number of vehicles	Capacity	Number of vehicles
Cap=50	26	Cap=25	51
Cap=45	29	Cap=20	59
Cap=40	33	Cap=15	67
Cap=35	37	Cap=15	74
Cap=30	44		

It is clear that as capacity increases, the number of vehicles to respond to decreases. In fact, the greater the carrying capacity, the easier it is to manage the flow between the hubs as well as the direct transmission, thus reducing the number of vehicles. The figure below shows the changes in the total number of vehicles to the changes in capacity.

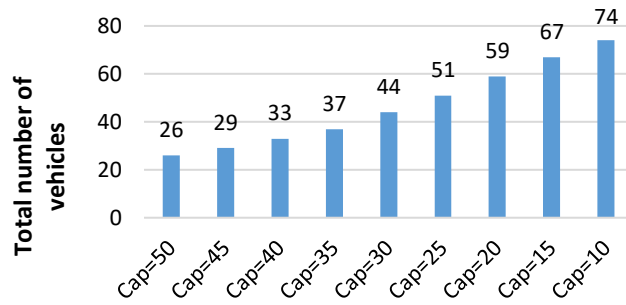

FIGURE 5
TOTAL NUMBER OF VEHICLES REQUIRED BASED ON CAPACITY

- Analysis of changes in the cost of building inter- hub infrastructure

Considering that one of the most important costs in transportation planning in hub networks is the cost of creating the necessary infrastructure for the development of communications in this type of network, in this section we will examine the effects of increasing and decreasing this The cost is paid on the values of the objective function as well as the number of hubs created. For this purpose, the cost of interstitial network connection in the range of 20%, 40%, and 60% increase/decrease, and the results are described.

TABLE 21
CHANGES OF OBJECTIVE FUNCTION SENTENCES BASED ON INCREMENTAL VALUES OF THE PARAMETER HL_{kl}

	HL_{kl} changes	the total value of the objective function	first sentence	second sentence	Third sentence	fourth sentence	Fifth sentence	sixth sentence	Number of hubs
Reduction	60 percent	111322	16475	9654	57197	17459	4125	6412	6
	40 percent	112659	16127	9834	59411	17053	3966	6268	5
	20 percent	116124	16127	10184	63317	16845	3457	6194	5
Additive	20 percent	171351	15962	10783	65008	16145	3337	60116	4
	40 percent	170321	15193	11549	70040	14928	3026	55585	3
	60 percent	180720	14182	12370	85597	13802	2879	51890	2

As expected, as the cost of building infrastructure increases/decreases, so does the cost of the entire system. Interestingly, the value of other statements of the objective function also increased/decreased, which indicates the great impact of this parameter on the model. It is expected that as this cost increases or decreases, the number of selected hub centers decreases or increases, and thus the total flow of shipments in the model changes. The following figure shows the graphical structure of cost changes.

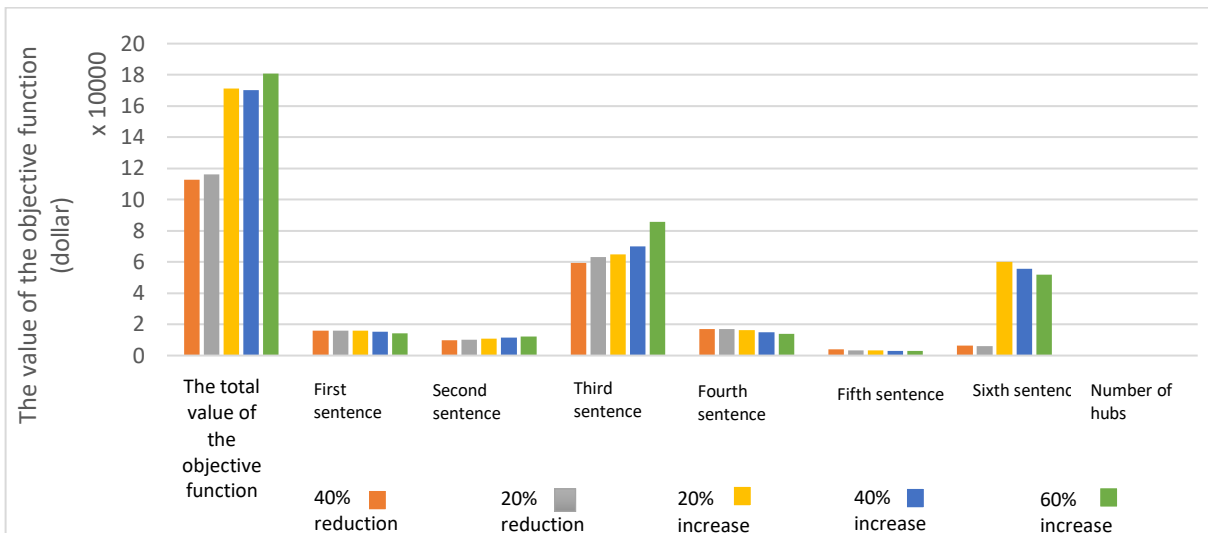

FIGURE 6
CHANGES IN THE OBJECTIVE FUNCTION SENTENCES VERSUS CHANGING THE HUB INFRASTRUCTURE COST PARAMETER

Regarding the number of hubs created, it can be said that increasing or decreasing the value of the parameter HL_{kl} causes the number of hubs to increase or decrease. This trend is shown in Table 22 and Figure 7 below.

TABLE 22
CHANGES IN THE NUMBER OF HUBS CONSTRUCTED VERSUS CHANGES IN HL_{kl}

	Increase amount HL_{kl}	Number of hubs
Reduction	60 percent	6
	40 percent	5
	20 percent	5
Additive	20 percent	4
	40 percent	3
	60 percent	2

It can be seen that the number of hubs has always had an unprecedented increase or decrease trend, and this is the reason why the model works properly as expected. Figure 7 shows this decreasing trend more specifically.

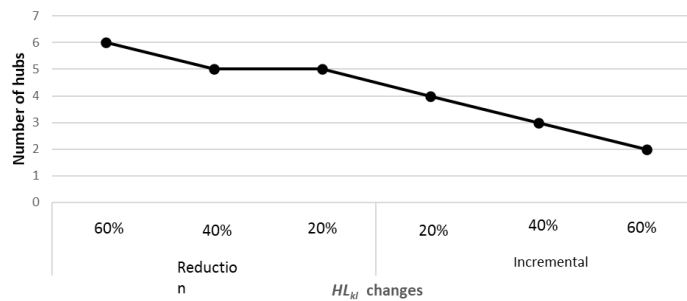

FIGURE 7
CHANGES IN THE NUMBER OF HUBS CREATED ACCORDING TO THE INCREMENTAL L VALUE OF THE PARAMETER HL_{kl}

MANAGERIAL IMPLEMENTATIONS

Logistics network design is one of the most important parts of supply chain management in various fields that seeks to find optimal solutions related to facility location, inventory management and vehicle routing. Therefore, the use of mathematical optimization tools can be used in making practical decisions. In this research, a new optimization model to design or improve the structure of global logistics networks in which raw materials are supplied from different countries and final products are produced in production centers around the world with the aim of increasing flexibility and agility. One of the main applications of this research can be considered in critical situations of coronavirus outbreak, which has disrupted the general activity of the supply chain. In addition, it should be noted that in recent months, the quarantine of populated areas and the imposition of legal restrictions on traffic in urban and rural areas has been proposed as a joint global program to combat the spread of the coronavirus. Although this program has had a positive impact on improving the global situation, it has caused some countries in the world to face the problem of supply and production of basic goods as a national concern due to the closure or closure of a large number of large food factories. To be. In this research, a new structure of global logistics networks is proposed in which the global hub network is used. One of the main advantages of using coordinated logistics hubs is that if one firm closes, the entire supply and production system is not affected and other centers can respond to market demand. Given that centers operating in global chains often face many financial problems, so providing government financial incentives can be a good way to strengthen their activities. According to the solved numerical examples, it is shown that the proposed logistics network can effectively manage all production operations required for different products in cross-linking between hubs and meet market demand. Also, increasing and decreasing the number of hubs does not disrupt the production process and in fact shows the high flexibility of the proposed logistics network. Therefore, using the results of this study can be used as a powerful management tool in corona crisis management.

SUMMARIZING AND FUTURE SUGGESTIONS

In this research, the design of the global logistics hub network as a mathematical optimization problem to improve product flow management between customer points has been investigated. The objective function of the proposed model is to minimize the fixed costs of constructing a hub, the cost of constructing an inter-hub infrastructure, the cost of transportation if the equipment is transported directly, and the cost of transportation if the hub network is used. The limitations of the model also include locating logistics hubs, managing flow between points, calculating transport time, and finally managing flow between network points. The use of global hubs, in addition to significantly reducing costs, can also lead to a reduction in service delivery time. Creating order integration channels and transport management through highways created between hubs reduces transportation operating costs and ultimately leads to near-optimal conditions. In addition, considering the time discount coefficient in intercity transportation compared to direct transportation has made the problem environment closer to the real-world situation; This is because there are a variety of examples in which consolidating shipments and shipping management can reduce operating costs. To evaluate the performance of the proposed model, a researcher-made numerical example based on real-world conditions with randomly generated data and sensitivity analysis on the problem outputs was performed. According to the results, it can be seen that the proposed model can produce justified and optimal global answers and therefore can solve real-world problems. Also, based on the sensitivity analysis, it can be seen that with increasing the amount of capacity, the values of the target function decrease.

In other words, if capacity is increased, there is a need for fewer vehicles and thus costs are reduced. It is also clear that as capacity increases, the number of vehicles to respond to decreases. In fact, the greater the carrying capacity, the easier it is to manage the flow between the hubs as well as the direct transmission, thus reducing the number of vehicles. In addition, as the cost of building infrastructure increases/decreases, the cost of the entire system is affected. Interestingly, the value of other statements of the objective function also increased/decreased, which indicates the great impact of this parameter on the model. It is expected that as this cost increases or decreases, the number of selected hub centers decreases or increases, and thus the total flow of shipments in the model changes. Regarding the number of hubs created, it can be said that increasing or decreasing the value of the parameter HL_{kl} causes the number of hubs to increase or decrease. Therefore, it can be said that the behavior of the model is by reality and therefore its performance is correct. To develop the operational and theoretical dimensions of the present study, various modes of transportation can be considered, including sea, land, and air transportation, which has always been one of the most important infrastructures for global logistics development. Also, since the problem of network design is a category of non-complex (NP-hard) problems, the development of solution algorithms based on innovative algorithms can provide suitable conditions for solving large-scale problems.

REFERENCES

- [1] Aljuneidi, T., & Bulgak, A. A. (2019). Carbon footprint for designing reverse logistics network with hybrid manufacturing-remanufacturing systems. *Journal of Remanufacturing*, 1-20 .
- [2] Bhatnagar, R., & Viswanathan, S. (2000). Re-engineering global supply chains: alliances between manufacturing firms and global logistics services providers. *International Journal of physical distribution & logistics management*, 30(1), 13-34 .
- [3] Budak, A. (2020). Sustainable reverse logistics optimization with triple bottom line approach: An integration of disassembly line balancing. *Journal of Cleaner Production*, 122475 .
- [4] Cheng, C., Qi, M., Zhang, Y., & Rousseau, L.-M. (2018). A two-stage robust approach for the reliable logistics network design problem. *Transportation Research Part B: Methodological*, 111, 185-202 .
- [5] Darmian, S. M., Moazzeni, S., & Hvattum, L. M. (2020). Multi-objective sustainable location-districting for the collection of municipal solid waste: Two case studies. *Computers & Industrial Engineering*, 150, 106965.
- [6] Dufour, É., Laporte, G., Paquette, J., & Rancourt, M. È. (2018). Logistics service network design for humanitarian response in East Africa. *Omega*, 74, 1-14 .
- [7] Falcone, E. C., Fugate, B. S., & Dobrzykowski, D. D. (2022). Supply chain plasticity during a global disruption: Effects of CEO and supply chain networks on operational repurposing. *Journal of Business Logistics*.
- [8] Farughi, H., & Mostafayi, S. (2017). A hybrid approach based on ANP, ELECTRE and SIMANP metaheuristic method for outsourcing manufacturing procedures according to supply chain risks-Case study: A medical equipment manufacturer company in Iran. *Decision Science Letters*, 6(1), 77-94.
- [9] Gao, X. (2019). A novel reverse logistics network design considering multi-level investments for facility reconstruction with environmental considerations. *Sustainability*, 11(9), 2710 .
- [10] Guerrero-Lorente, J., Gabor, A. F., & Ponce-Cueto, E. (2020). Omnichannel logistics network design with integrated customer preference for deliveries and returns. *Computers & Industrial Engineering*, 106433 .
- [11] Guerrero, D. (2020). A global analysis of hinterlands from a European perspective. In: *Global Logistics Network Modelling and Policy: Quantification and Analysis for International Freight*. A global analysis of hinterlands from a European perspective. In: *Global Logistics Network Modelling and Policy: Quantification and Analysis for International Freight*, 18p .
- [12] Jiang, J., Zhang, D., Li, S., & Liu, Y. (2019). Multimodal green logistics network design of urban agglomeration with stochastic demand. *Journal of Advanced Transportation*, 2019 .
- [13] Jiang, J., Zhang, D., Meng, Q., & Liu, Y. (2020). Regional multimodal logistics network design considering demand uncertainty and CO2 emission reduction target: A system-optimization approach. *Journal of Cleaner Production*, 248, 119304 .
- [14] John, S. T., Sridharan, R., & Kumar, P. R. (2018). Reverse logistics network design: a case of mobile phones and digital cameras. *The International Journal of Advanced Manufacturing Technology*, 94(1), 615-631 .
- [15] John, S. T., Sridharan, R., Kumar, P. R., & Krishnamoorthy, M. (2018). Multi-period reverse logistics network design for used refrigerators. *Applied Mathematical Modelling*, 54, 311-331 .
- [16] Kim, Y. G., & Do Chung, B. (2022). Closed-loop supply chain network design considering reshoring drivers. *Omega*, 102610.
- [17] Kuşakcı, A. O., Ayvaz, B., Cin, E., & Aydın, N. (2019). Optimization of reverse logistics network of End-of-Life Vehicles under fuzzy supply: A case study for Istanbul Metropolitan Area. *Journal of Cleaner Production*, 215, 1036-1051 .
- [18] Kwag, S. I., & Ko, Y. D. (2019). Optimal design for the Halal food logistics network. *Transportation Research Part E: Logistics and Transportation Review*, 128, 212-228 .
- [19] Lavassani, K. M., Movahedi, B., & Iyengar, R. J. (2022). Multi-layer, multi-tier analysis of global supply chain in medical equipment sector: network science application. *Transnational Corporations Review*, 1-17.
- [20] Li, L., & Liu, Z. P. (2022). A connected network-regularized logistic regression model for feature selection. *Applied Intelligence*, 1-31.
- [21] Liao, T.-Y. (2018). Reverse logistics network design for product recovery and remanufacturing. *Applied Mathematical Modelling*, 60, 145-163 .
- [22] Liu, M., Cao, J., Liang, J., & Chen, M. (2020). Epidemic-Logistics Network Considering Time Windows and Service Level Epidemic-logistics Modeling: A New Perspective on Operations Research (pp. 259-280): Springer.
- [23] Lu, S., Zhu, L., Wang, Y., Xie, L., & Su, H. (2020). Integrated forward and reverse logistics network design for a hybrid assembly-recycling system under uncertain return and waste flows: A fuzzy multi-objective programming. *Journal of Cleaner Production*, 243, 118591 .
- [24] Mangan, J., & Lalwani, C. L. (2016). *Global logistics and supply chain management*: John Wiley & Sons.
- [25] Mishra, S., & Singh, S. P. (2020). Designing dynamic reverse logistics network for post-sale service. *Annals of Operations Research*, 1-30 .
- [26] Mostafayi, S., Moazeni, S., Dahmardeh, M., & Mokhtari, K. (2015). *Vehicle routing problem with regard to simultaneous pickup and delivery, time windows and workers assignment on the basis of their abilities and availability* (Vol. 3, No. 1, pp. 423-434). MAGNT Research Report.
- [27] Ohmori, S., & Yoshimoto, K. (2019). Global logistics network design problem with rules of origin. *Journal of Industrial Engineering and Management*, 12(3), 447-457 .
- [28] Oyola-Cervantes, J., & Amaya-Mier, R. (2019). Reverse logistics network design for large off-the-road scrap tires from mining sites with a single shredding resource scheduling application. *Waste Management*, 100, 219-229 .
- [29] Park, K., Kim, J., Ko, Y. D., & Song, B. D. (2020). Redesign of reverse logistics network with managerial decisions on the minimum quality level and remanufacturing policy. *Journal of the Operational Research Society*, 1-14 .
- [30] Prinzie, A., & Van den Poel, D. (2005). Constrained optimization of data-mining problems to improve model performance: A direct-marketing application. *Expert systems with applications*, 29(3), 630-640 .
- [31] Rahimi, M., & Ghezavati, V. (2018). Sustainable multi-period reverse logistics network design and planning under uncertainty utilizing conditional value at risk (CVaR) for recycling construction and demolition waste. *Journal of Cleaner Production*, 172, 1567-1581 .
- [32] Reddy, K. N., Kumar, A., & Ballantyne, E. E. (2019). A three-phase heuristic approach for reverse logistics network design incorporating carbon footprint. *International Journal of Production Research*, 57(19), 6090-6.1114
- [33] Robischon, N. (2017). Why Amazon is the world's most innovative company of 2017. *Fast Company* .
- [34] Sadmia, A., Langarudi, N. R., & payandeh Sani, A. (2020). Logistics network design to reuse second-hand household appliances for charities. *Journal of Cleaner Production*, 244, 118717 .

- [35] Shah, S., Rutherford, R., & Menon, S. (2020). Emerging technologies of IoT usage in global logistics. Paper presented at the 2020 International Conference on Computation, Automation and Knowledge Management (ICCAKM).
- [36] Somnuek, P. (2017). Potential of Tourism Logistic Service Business in the Border Areas of Chong Anma, Chong Sa-Ngam, and Chong Jom Checkpoints in Thailand to Increase Competitive Efficiency among the ASEAN Community. *World Academy of Science, Engineering and Technology, International Journal of Social, Behavioral, Educational, Economic, Business and Industrial Engineering*, 11(4), 844-847 .
- [37] Song, D.-W., & Parola, F. (2015). Strategising port logistics management and operations for value creation in global supply chains: Taylor & Francis.
- [38] Tohidi, H. (2015). Mathematical modeling of optimal multi fuzzy locations of facilities based on the assumed step distance among them in a convex set. *Applied Mathematical Modelling*. 39(23–24): 7442-7451, <https://doi.org/10.1016/j.apm.2014.12.048>.
- [39] Tchamyou, V. S. (2017). The role of knowledge economy in African business. *Journal of the Knowledge Economy*, 8(4), 1189-1228 .
- [40] Tosarkani, B. M., Amin, S. H., & Zolfagharinia, H. (2020). A scenario-based robust possibilistic model for a multi-objective electronic reverse logistics network. *International Journal of Production Economics*, 224, 107557 .
- [41] Trochu, J., Chaabane, A., & Ouhimmou, M. (2019). A two-stage stochastic optimization model for reverse logistics network design under dynamic suppliers' locations. *Waste Management*, 95, 569-583 .
- [42] Trochu, J., Chaabane, A., & Ouhimmou, M. (2020). A carbon-constrained stochastic model for eco-efficient reverse logistics network design under environmental regulations in the crd industry .*Journal of Cleaner Production*, 245, 118818 .
- [43] Vanajakumari, M., Kumar, S., & Gupta, S. (2016). An integrated logistic model for predictable disasters. *Production and Operations Management*, 25(5), 791-811 .
- [44] Vasiliauskas, A. V., & Jakubauskas, G. (2007). Principle and benefits of third party logistics approach when managing logistics supply chain. *Transport*, 22(2), 68-72 .
- [45] Wang, Y., Zhang, S., Guan, X., Peng, S., Wang, H., Liu, Y., & Xu, M. (2020). Collaborative multi-depot logistics network design with time window assignment. *Expert Systems with Applications*, 140, 112910 .
- [46] Wang, Z., Huang, L., & He, C. X. (2019). A multi-objective and multi-period optimization model for urban healthcare waste's reverse logistics network design. *Journal of Combinatorial Optimization*, 1-28 .
- [47] Wang, M., & Huang, H. (2019). The design of a flexible capital-constrained global supply chain by integrating operational and financial strategies. *Omega*, 88, 40-62.
- [48] Yamaguchi, T., Shibasaki, R., Samizo, H., & Ushirooka, H. (2021). Impact on Myanmar's Logistics Flow of the East–West and Southern Corridor Development of the Greater Mekong Subregion—A Global Logistics Intermodal Network Simulation. *Sustainability*, 13(2), 668 .
- [49] Yan, L., Wen, Y., Teo, K. L., Liu, J., & Xu, F. (2020). Construction of Regional Logistics Weighted Network Model and Its Robust optimization: Evidence from China. *Complexity*, 2020 .
- [50] Yu, H., Sun, X., Solvang, W. D., & Zhao, X. (2020). Reverse logistics network design for effective management of medical waste in epidemic outbreaks: Insights from the coronavirus disease 2019 (COVID-19) outbreak in Wuhan (China). *International Journal of Environmental Research and Public Health*, 17, 105072-105085 .
- [51] Yuchi, Q., Wang, N., Li, S., Yang, Z., & Jiang, B. (2019). A bi-objective reverse logistics network design under the emission trading scheme. *IEEE Access*, 7, 105072-105085 .
- [52] Zarbakhshnia, N., Soleimani, H., Goh, M., & Razavi, S. S. (2019). A novel multi-objective model for green forward and reverse logistics network design. *Journal of cleaner production*, 208, 1304-1316 .
- [53] Zijm, H., Klumpp, M., Heragu, S., & Regattieri, A. (2019). *Operations, Logistics and Supply Chain Management: Definitions and Objectives Operations, Logistics and Supply Chain Management* (pp. 27-42): Springer.