



Coordination Design of Power System Stabilizer and FACTS Controllers Using Nature-Inspired Metaheuristics Optimization Algorithms– A Brief Review

S. Mohammadali Zanjani^{1,2*}, Ghazanfar Shahgholian^{1,2*}, Arman Fathollahi³, Sayed Mohammed Hosain Zanjani^{1,2}

¹Department of Electrical Engineering, Najafabad Branch, Islamic Azad University, Najafabad, Iran

²Smart Microgrid Research Center, Najafabad Branch, Islamic Azad University, Najafabad, Iran, zanjani.sma@gmail.com

³Department of Electrical and Computer Engineering, Aarhus University, Aarhus, Denmark

Abstract

Electromechanical oscillations in power systems usually exist due to incompatible conditions and disturbances in the network. Meta-heuristics using search strategy are used to find near-optimal solutions. Typically, the implementation of this approach involves the utilization of a fitness function to assess the candidate solutions. In nature-inspired metaheuristics optimization algorithms, an analogy from nature is used to generate approximate solutions for practical optimization problems. This work presents a comprehensive investigation into various nature-inspired optimization algorithms, including ant colony optimization, genetic algorithm, and bat algorithm. The primary focus of this paper is to explore their efficacy in the coordinated design of Power System Stabilizers (PSS) and Flexible Alternating Current Transmission Systems (FACTS). The objective of this coordinated design is to improve energy system stability and mitigate power system oscillations. Finally, new directions are provided to researchers who work in the field of applications of nature-inspired optimization algorithms and coordination configuration of PSS and FACTS regulators.

Keywords: renewable energy, flexible alternating current transmission system, power system stabilizer, optimization algorithms

Article history: Received 2023/08/01; Revised 2023/10/01; Accepted 2023/10/30. Article Type: Research paper

© 2024 IAUCTB-IJSEE Science. All rights reserved

<https://doi.org/10.30495/ijsee.2023.1992877.1278>

1. Introduction

Energy is an essential requirement for the sustained progress of economic development, social well-being, enhancement of quality of life, and societal security [1,2]. The efficient storage of electric energy on a wide scale remains a challenge, necessitating the establishment of a balance between grid demand and consumption as a primary operational requirement [3-14].

The significance of energy supply is paramount in light of the advancements in the industry and the increasing necessity for electrical energy. This holds particular economic importance, while simultaneously acknowledging the demand to address environmental concerns [15,16]. In light of the economic and environmental characteristics, it is advisable to locate energy-producing facilities at a substantial distance from consumption centers. The obligation of transporting this energy lies with the

transmission grid, as indicated by previous studies [17,18]. The proliferation of renewable power sources and their influence on the traditional energy grid is experiencing considerable growth [19,20]. The influential integration of power electronic converters, such as photovoltaic, wind, and solar systems, in the power grid has led to a transformation in the performance and control of the interconnected power system. This has resulted in a heightened focus on maintaining and enhancing stability, which has emerged as a crucial and pivotal undertaking [21,22]. Recently, the growing scarcity of non-renewable energy resources has led to increased recognition of the significance of renewable energies on a global scale. Consequently, several studies have been undertaken to investigate and harness the potential of these resources [23,24].

Nowadays, academics have dedicated significant efforts to analysing and developing methods to enhance the dynamic stability of energy networks and mitigate low frequency variations. The utilization of a controller within the power system serves the objective of enhancing its stability and responsiveness towards dynamic alterations in system conditions [25,26].

A) *Power oscillations damping*

The power system is encountering continuous growth, and the mitigation of oscillations is of utmost importance in guaranteeing the dependable transfer of power to various types of loads [27,28]. The interconnection of an energy grid through a weak transmission line results in the occurrence of low-frequency oscillations within the grid. In the event that the level of damping is inadequate, these oscillations can lead to disturbances in the power network [29,30]. This issue in the energy grid is addressed through the implementation of power oscillations dampening techniques [31,32]. The major risk to the stability of modern systems is energy fluctuations. The Power System Stabiliser (PSS) is employed to mitigate oscillations, while Flexible Alternating Current Transmission System (FACTS) devices are utilized to improve damping performance [33,34].

B) *Short summary of optimization algorithms*

The primary aim of optimization algorithms is to identify a viable solution that aligns with the constraints and requirements of the situation at hand [35,36]. In addressing a given problem, it is possible for there to exist multiple solutions. Hence, in order to evaluate and select the most favourable solution, it is crucial to take into account the objective function, which is contingent upon the problem's characteristics [37,38]. Hence, the selection of the objective function can be identified as a paramount stage within an optimization technique [29].

Several optimization strategies have been discussed in the literature, each targeting different objectives. For instance, the studies have highlighted the improved whale optimization algorithm [40], the crow search technique [41], the hybrid rectified grey wolf optimization cosine algorithm [42], the intelligent bacteria foraging technique [43], the cuckoo search with the ability for partial shading [44], and the particle swarm optimization [45]. It is worth noting that all three of these optimization methods have been employed in the design of regulators and stabilizers in the multi-machine energy system.

C) *Innovation and contributions*

In this paper, we have conducted a concise yet comprehensive review focused on the tuning of PSS and FACTS devices, with the explicit goal of enhancing stability and damping of oscillations. To achieve this, we leveraged the power of nature-inspired metaheuristics optimization algorithms. By meticulously studying and analysing over 100 articles, our research aims to offer valuable insights and novel directions to researchers working in the field of nature-inspired optimization algorithms and the coordination design of FACTS and PSS controllers. The primary innovation of this study lies in its exploration of cutting-edge approaches to improving the performance of power systems by integrating nature-inspired metaheuristics. By synthesizing the knowledge gathered from a diverse range of sources, we have provided an up-to-date and coherent overview of the efficacy of these optimization algorithms in addressing stability and damping issues. Through a rigorous examination of various techniques and methodologies applied in real-world scenarios, we have identified key strengths and potential areas for further development in this field. Furthermore, our work contributes to the broader domain of power system engineering by highlighting the viability of nature-inspired metaheuristics as a promising avenue for enhancing control strategies in PSS and FACTS devices. This paper not only showcases the current state of research in the application of such algorithms but also emphasizes their practical significance in addressing critical challenges faced by modern power systems.

D) *Paper organization and structure*

This work furnishes a concise review of metaheuristic optimization strategies inspired by nature for the coordination design of FACTS and PSS regulators, based on existing investigations. This study is organized in the following manner. The configuration of the power system stabilizer is explained in Section 2. Section 3 provides a concise review of the various types of FACTS devices. The utilization of various nature-inspired metaheuristics optimization algorithms for the coordinated structure of controllers is explicated in section 4. To overcome the disadvantages of the optimization procedure, a combination of several methods is examined. Ultimately, the conclusion is illustrated in section 5.

2. Power System Stabilizer

The utilization of weak connection lines in extensive power systems results in the occurrence of low frequency oscillations within the energy network. If these oscillations are not sufficiently dampened, they have the potential to escalate and

ultimately lead to the disconnection of the power system [46,47]. The primary purpose of implementing PSS is to develop supplementary control signals for the synchronous machine's excitation system, with the aim of mitigating both inter-area mode and local mode oscillations [48,49]. The performance and efficiency of the system are contingent upon the implementation and identification of the most suitable location and design for the parameters [50,51]. The selection of the location and optimal local input signals is accomplished via the utilization of the deterministic procedure and time domain simulation examination [52,53]. The configuration of a PSS, seen in Fig. 1, comprises a wash filter, lead-lag compensation block, gain block, and limiter [54,55].

In order to achieve adequate damping of electromechanical oscillations, several metaheuristic optimization algorithms, including gradient-based and hybrid gorilla troops optimization techniques [56], as well as Tabu search [57], have been employed for tuning PSS parameters. Additionally, intelligent control design techniques such as fuzzy logic [58,59] and artificial neural networks [60,61], have also been utilized. In an investigation conducted by the authors of [62], a technique is suggested that utilizes artificial neural networks to dynamically adjust PSS parameters in real time. The delivered procedure involves selecting two online measurements, namely generator power factor and real power output, as input signals for the neural network. The neural network then accommodates the appropriate PSS parameters as outputs. The study conducted in [63] examines the impact of utilizing an artificial neural network as a power system stabilizer to mitigate multi-mode oscillations in a five-machine energy system.

The input for the neural network is the accelerating power of the producing unit. The neural network is additionally trained to retain the inverse output/input mapping of the synchronous machine. The research introduces the utilization of recurrent neural networks (RNNs) for the adaptive design of PSS. The proposed adaptive PSS framework consists of two RNNs: a tracker network that learns the dynamic features of the energy plant, and a regulator network that mitigates disturbances-induced fluctuations. This technique is presented in [64].

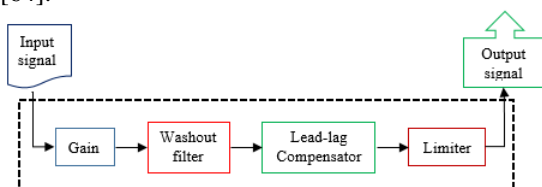

Fig. 1. Structure of conventional power system stabilizer

3. Overview of FACTS Devices Types

In the context of a power system, the coordination between production and demand becomes an essential and significant factor due to the ever-increasing need for electrical energy. As the demand for electricity continues to rise, it becomes crucial to strike a balance between the amount of energy being produced and the amount required by consumers.

Effective coordination ensures that the power system can efficiently meet the growing demands without compromising its stability, reliability, and overall performance. By properly managing the generation and distribution of electrical energy, power systems can function optimally and cater to the needs of consumers, industries, and various sectors relying on a steady and uninterrupted power supply. This coordination also plays a vital role in supporting economic growth, technological advancements, and societal well-being, making it a fundamental aspect of modern power system planning and operation [65,66]. Hence, in order to effectively address the surge in demand, it is imperative for all constituent elements to function at their utmost efficiency [67,68]. FACTS tools are employed to enhance the effectiveness of the transmission grid [69,70]. The utilization of FACTS devices encompasses several benefits, including load distribution control, reduction of transmission line losses, enhancement of dynamic stability, reinforcement of transient stability, improvement of dependability and security, enhancement of power quality, and optimization of voltage profile [71,72].

The categorization of FACTS devices based on the manner in which tools are connected to the power system is depicted in Fig. 1. The separation into two categories, namely one-port, and two-port, has been documented in previous studies [73,74]. This section provides a brief overview of many commonly utilized FACTS devices.

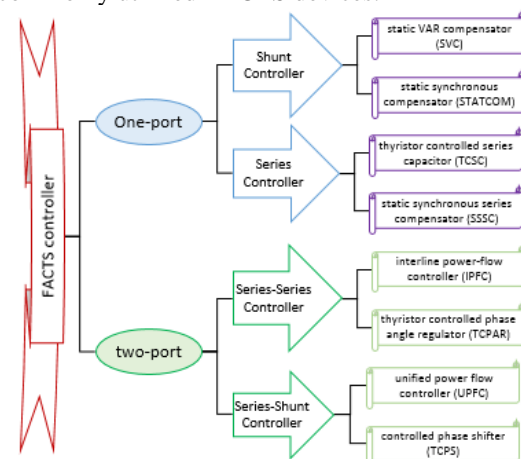

Fig. 2. The categorization of FACTS devices according to their connection type

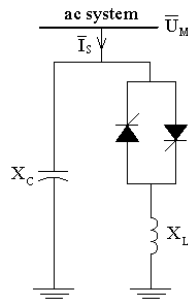

Fig. 3. Basic diagram of static VAR compensator

A) Static VAR Compensator (SVC)

The Static VAR Compensator (SVC) is an essential element inside power networks, specifically engineered to enhance the stability and overall efficiency of the transmission network. The system has a static capacitor bank that is coupled in parallel with an inductor controlled by thyristors. This configuration enables accurate regulation of the power consumed by the inductor.

The SVC is capable of successfully manipulating the reactive power flow, hence facilitating the adjustment of voltage levels, enhancement of power factor, mitigation of harmonics, and stabilization of the transmission network. The fixed capacitor bank of the Static Var Compensator (SVC) plays a vital role in the generation or absorption of reactive power, depending on the specific characteristics of the energy system [75].

When the electrical network requires a significant amount of reactive power in the form of capacitance, the capacitor bank is utilized to supply the required support to compensate for the reactive power that is lagging. On the other hand, in situations where there is a decrease in reactive power demand, namely inductive loads, the thyristor-controlled inductor is employed to regulate the flow of power. This regulation is necessary to maintain a power factor that is both balanced and stable within the network. The basic diagram of static VAR compensator is illustrated in Fig. 2.

B) Static Synchronous Compensator (STATCOM)

The Synchronous Static Compensator (STATCOM) is an advanced device engineered to offer swift and accurate regulation of reactive current at the point of interface with the power system. The component in question plays a pivotal function in the regulation of voltage at the site of connection and is renowned for its rapid response time. The STATCOM, apart from its capability to inject or absorb reactive power, also exerts an influence on active power, so establishing itself as a

versatile and potent compensator inside power systems. When comparing SVC and STATCOM, it is generally observed that STATCOM demonstrates superior characteristic curves, hence improving its effectiveness in voltage control and power regulation [76,77].

One of the noteworthy advantages of STATCOM in comparison to SVC is its capacity to influence both active and reactive power transmission. The utilization of STATCOM enables enhanced flexibility and efficiency in addressing voltage stabilization and power quality enhancement inside the grid by effectively managing both power components.

This functionality enables operators to optimize the power distribution according to the specific needs of the system and promptly adapt to changes in load demand. The utilization of STATCOM in power systems encompasses a range of applications, notably the enhancement of stability and the mitigation of sub-synchronous oscillations inside wind farms. Wind farms are susceptible to sub-synchronous resonance problems, which can result in unfavorable power oscillations and instability. The rapid response and accurate regulation of reactive power by STATCOM provide it a suitable remedy for mitigating these oscillations and improving the overall stability of wind farm integration into the grid [78,79]. The fundamental diagram of static synchronous compensator is depicted in Fig. 3.

C) Thyristor-Controlled Series Capacitor (TCSC)

The Thyristor-Controlled Series Capacitor (TCSC) is a significant device utilized in power systems for the purpose of regulating the series impedance and improving the efficiency of power transmission. The system comprises a capacitive reactance that is linked in series with the power supply, enabling the dynamic manipulation of the series capacitance. The TCSC system consists of a parallel connection between a capacitor bank and a thyristor-controlled reactor [80].

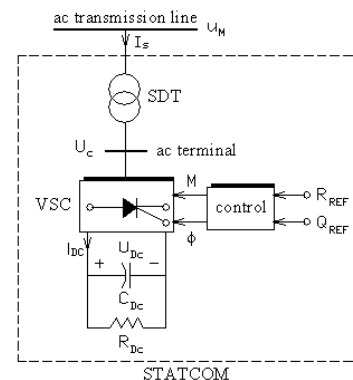

Fig. 4. Basic diagram of STATCOM

The fundamental function of the capacitor bank is to introduce a variable and continuous series capacitance, which can be modified as required to improve the energy flow and voltage regulation in the transmission line [81,82]. Through the manipulation of thyristors, the TCSC can modify the effective capacitance within the system. This adjustment enables the regulation of impedance and subsequently impacts the flow of power. The operation of the TCSC is contingent upon its dynamic capability to manipulate the capacitive reactance instantaneously.

Under typical operating conditions, where power flow remains within acceptable parameters, the thyristors maintain a state of high impedance, leading to the presence of a substantial series of capacitive reactance. This process significantly raises the voltage of the line, hence improving the efficiency of power transmission. Nevertheless, in situations of contingency or high demand, it is possible to activate the thyristors to diminish impedance. This action results in a reduction of series capacitance, effectively counteracting voltage drops or disruptions within the power system.

The control mechanism of the TCSC enables prompt response to system conditions, facilitating dynamic compensation and ensuring the stability of power transmission. The TCSC assists in the mitigation of voltage fluctuations, improvement of overall system stability, and dampening of oscillations through the regulation of the series capacitance [83,84]. Thyristors are used to control system impedance. A simple block diagram of thyristor-controlled series capacitor is illustrated in Fig. 4.

A) Static Synchronous Series Compensator (SSSC)

The Static Synchronous Series Compensator (SSSC) is a prominent apparatus employed in energy systems to augment the controllability and stability of transmission lines. The system consists of a high-voltage direct current (HVDC) source and a transformer, which are interconnected in series with the transmission line.

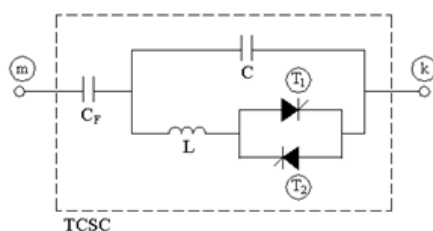

Fig. 5. Simple block diagram of thyristor-controlled series capacitor

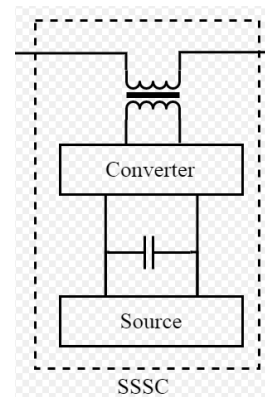

Fig. 6. Simple block diagram of static synchronous series compensator

The main purpose of the SSS) is to introduce a nearly sinusoidal voltage in series with the power transmission line. SSSC functions as a regulated voltage source, providing the ability to autonomously adjust its voltage magnitude within a predetermined operational span, irrespective of the line current [85,86].

This distinctive attribute enables operators to effectively control and enhance the voltage profile along the transmission line, thereby minimizing voltage dips or fluctuations that may arise as a result of fluctuating loads or disturbances in the grid. The SSSC is capable of modifying the line impedance and exerting control over the flow of reactive power by introducing an adjustable voltage in series with the line. The aforementioned capability renders it an important asset for power flow manipulation and voltage regulation, as it possesses the potential to promptly adapt to evolving grid circumstances and actively facilitate the transmission of power between distinct sections of the network [87,88].

B) Interline Power Flow Controller (IPFC)

The Interline Power Flow Controller (IPFC) is a sophisticated device employed in power networks for the goal of managing energy flow and improving the overall stability and efficiency of interconnected transmission lines. The IPFC is comprised of many voltage source converters that are interconnected in a series configuration with the transmission lines via coupling transformers [89,90].

The IPFC primarily serves the purpose of series reactive compensation. The IPFC can inject or absorb reactive power into the transmission lines by manipulating the output of the voltage source converters. This functionality enables the system to manage the line impedance and efficiently govern the power transfer between interconnected grids or transmission corridors. The IPFC can effectively regulate reactive power flow, leading to the mitigation of voltage fluctuations, enhancement of

voltage profiles, and overall improvement in power system stability [91,92]. The configuration of the controller is depicted in Fig. 5.

C) Unified Power Flow Controller (UPFC)

Power systems use the Unified Power Flow Controller (UPFC) to modify transmission line settings in real time. It controls transmission line dynamic power flow by changing line impedance, node voltage, and phase angle [93,94]. The UPFC actively regulates transmission line power flow. The UPFC balances power transfer between grid sectors by dynamically altering line impedance and other factors. This optimizes power flow distribution and reduces line congestion and overloading.

However, like any sophisticated power system device, UPFC interruption during abnormal conditions can threaten power system stability [95,96]. Thus, the UPFC must have sufficient safeguards to operate reliably and uninterruptedly. The UPFC reduces rotor oscillations to boost generator damping [97]. This damping increase improves the power system's dynamic stability and disturbance responsiveness. The UPFC should behave like a PSS [98,99]. How to connect the converters in the controller is presented in Fig. 6.

4. Literature Review

Several researchers have employed meta-heuristic techniques to individually adjust the coefficients of power system stabilizers and to locate or create controllers for FACTS devices [100,101].

Several techniques have been suggested for the synchronization of FACTS and PSS [102,103]. This section presents a concise description of the coordination control between FACTS and PSS regulators, utilizing optimization strategies inspired by nature. A concise explanation is furnished by a description of its use in the coordinating design of controller parameters.

A) Genetic Algorithm (GA)

The Genetic Algorithm (GA) is well recognized as a prominent example of swarm intelligence search. The algorithm in question emulates the biological phenomenon of natural selection, incorporating three fundamental evolutionary operators: crossover, mutation, and selection. The utilization of genetic algorithms for the identification of genetic models and the detection of epistasis has been found to be straightforward [104,105]. Fig. 7 illustrates the overall procedure of executing the algorithm, which is subject to variation depending on the specific goal function [106,107]. The paper presented in [1] introduces a method for the robust tuning of proportional integral derivative (PID) SVC

and PSS in multi-machine energy systems. The adapting is performed using a genetic algorithm. The placement of PSS and SVC is decided using participation factors and the residue approach, respectively.

B) Particle Swarm Optimization (PSO)

The particle swarm optimization (PSO) methodology is a population-based stochastic optimization method that is particularly suitable for optimizing nonlinear functions in multidimensional space [109,110]. The strategy presented below draws inspiration from the collective movement patterns observed in avian species during foraging activities.

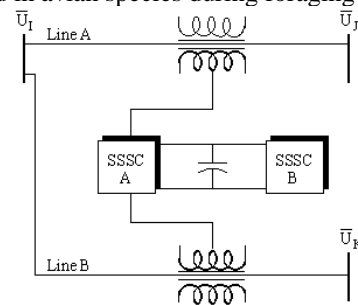

Fig. 7. IPFC basic configuration arrangement

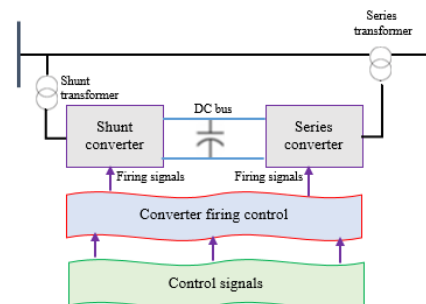

Fig. 8. UPFC basic configuration arrangement

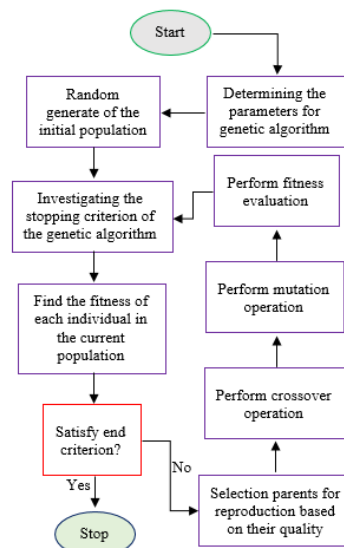

Fig. 9. Flowchart of the genetic algorithm

The fitness value of each solution is determined through the utilization of a fitness function. Every individual particle possesses a specific velocity and assumes the role of governing the trajectory of such particle [2,3]. Every individual particle in the problem space persists in its movement by adhering to the optimal particles present in the current state. The utilization of this strategy demonstrates a wide range of applications in problem-solving [4,5]. Fig. 8 displays the flowchart illustrating the various stages of the procedure [6,7].

One of the notable features of this algorithm is the utilization of all available historical data, fostering collaboration and information sharing among particles. Additionally, it offers simplicity in both implementation and execution, along with the ability to effectively address local optimal problems. Furthermore, it demonstrates a high convergence speed [8]. Additionally, this technique is associated with drawbacks such as premature convergence, the entrapment of particles in local optima, and a decrease in population variety [9,10].

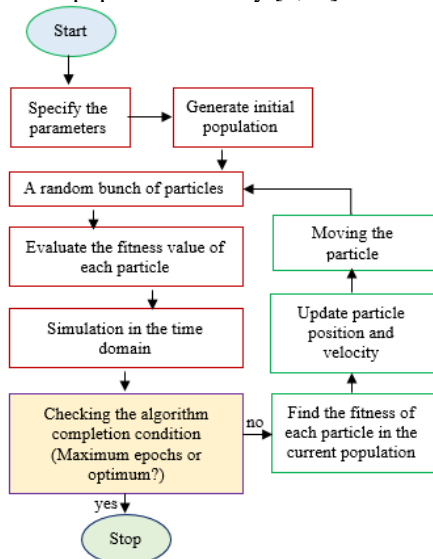

Fig. 10. A view of the PSO algorithm process

The paper [11] presents a study on the best placement of STATCOM and its coordinated structure with PSS for enhancing energy stability. The research focuses on the optimization problem of designing a compensator with a stabilizer, which is solved using the PSO approach. The findings from the nonlinear simulation establish that the strategic placement of the compensator in the best position yields enhancements in the transient stability of the power system.

Furthermore, the coordinated design approach effectively enhances the damping characteristics of the power system. In the study presented in reference [12], a proposal is made to improve the stability of a energy grid through the implementation

of coordination techniques for SSSC and PSS. The authors employ a hybrid optimization approach, combining the Bacteria Foraging Optimisation approach (BFOA) and PSO, to efficiently search for the best parameters of the regulators.

Fig. 9 illustrates the behavior of system speed deviation in response to a heavy load scenario with a load interruption occurring at bus 1, specifically at the 1-second mark, lasting for a duration of 100 milliseconds. The suggested strategy effectively mitigates power system fluctuations, resulting in rapid stabilization of the system even in the presence of potential alterations. Fig. 10 illustrates the speed deviation of the system when subjected to variations in generator loading and the presence of a 3-cycle and 3-phase fault in the transmission line. The aforementioned simulation outcomes demonstrate the improved performance of the combined strategy in comparison to the GA.

In [13], showcases the utilization and assessment of three optimization techniques, namely GA, PSO, and Farland Fertility Algorithm (FFA), for the purpose of designing coordination amongst stabilizers in a multi-machine energy system. Fig. 11 illustrates the rate at which the stabilizer design index converges in a power grid consisting of multiple machines.

In this particular scenario, we are examining a three-phase fault occurring in bus 39, with a duration of 100 milliseconds, precisely at the 1-second mark. The data demonstrates that the agricultural fertility algorithm approach exhibits a notably higher convergence rate (92 iterations) in comparison to both PSO (78 iterations) and GA (83 iterations). To improve the stability of the energy grid in [14], researchers have employed a combination of PSS and TCSC. To determine the appropriate controller parameters, they utilized the Velocity Update Relaxation Particle Swarm Optimisation (VURPSO) technique and the GA.

The figures, labeled as Figs. 12 and 13, depict the rotor angle response of machines 1 and 4, respectively, in reaction to a disturbance. The utilization of both VURPSO and GA algorithms has demonstrated a notable improvement in the system's stability, surpassing the efficacy of the remaining two approaches. Figs. 14 and 15 depict the variations in machine speed within a single machine power system under two scenarios: (a) when the POD controller function is only performed by the UPFC, and (b) when a coordinated design is implemented between the UPFC and PSS. The coordination of design between the UPFC and the PSS is achieved through the utilization of two optimization approaches, namely Dolphin Echolocation Optimisation (DEO) and PSO. The coordinated structure of PSS and Unified Power Flow Controller - Phase-Order Decomposition

(UPFC-POD) yields improved dynamic responsiveness. Additionally, it has been detected that the utilization of DEO has resulted in reduced fluctuations compared to the PSO technique, as well as a significantly faster response time [15].

C) Artificial Bee Colony (ABC)

One of the optimization techniques belonging to the group of swarm intelligence algorithms, which simulates the foraging behavior of honeybees, the artificial bee colony (ABC) algorithm is an optimization technique [16,17]. This method has been successfully applied to various practical problems [18,19,28]. In this algorithm, there are three types of bees: (a) employed bees (foraging around a food source and sharing information with onlooker bees), (b) onlooker bees (choosing a higher quality food source) and (c) scout bees (abandoning their food sources and seeking new ones) [20,21]. In the ABC algorithm, the first half and the second half of the swarm include used bees and onlooker bees, respectively [22] [23]. The flowchart of this method is depicted in Fig. 16 [24] [25].

To coordinate between STATCOM and PSS to improve the better damping of electromechanical oscillations, the ABC algorithm is employed in [26], and the outcomes are analogized with the PSO strategy. The simulation results in a two-area four-machine system show the advancement of electromechanical oscillation damping in the area and inter-area modes using the ABC technique compared to the PSO strategy.

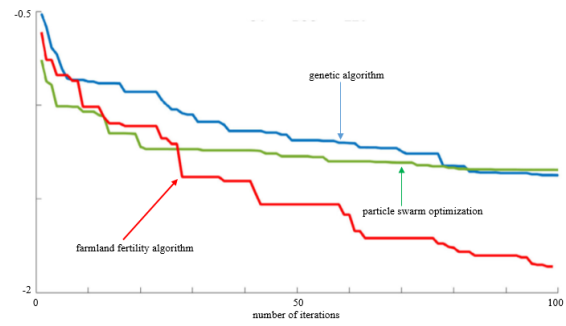

Fig. 13. Convergence characteristics of three optimization methods to find PSS design parameters

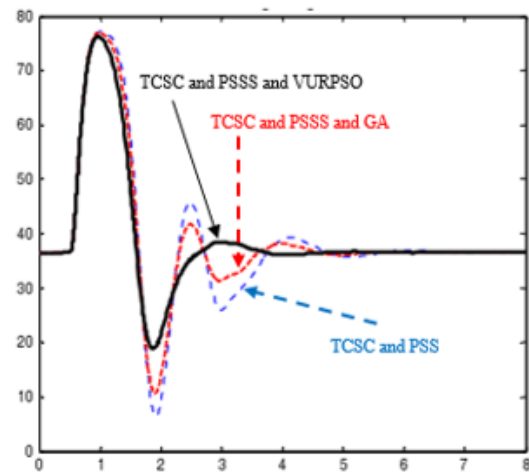

Fig. 14. Compare the answer rotor angle of generator 1

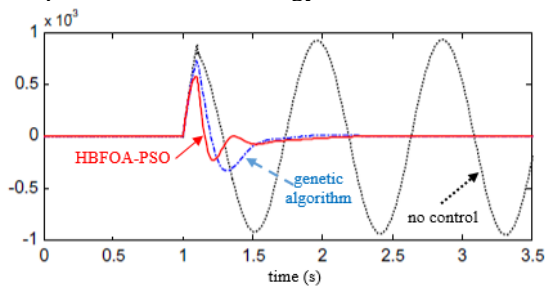

Fig. 11. Effect of small perturbations on system speed deviation under heavy loading conditions

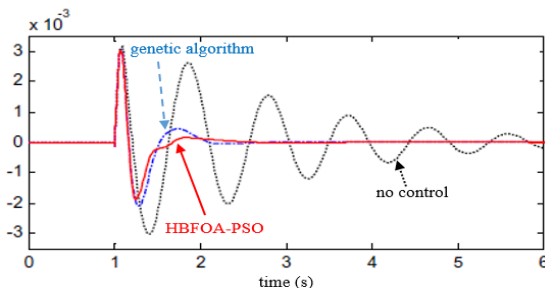

Fig. 12. The effect of 3-cycle 3-phase fault near bus 3 with line disconnection on system speed deviation under light load conditions was removed

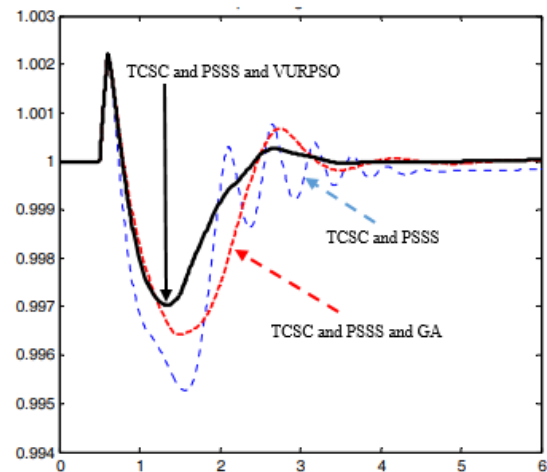

Fig. 15. Compare the answer rotor angle of generator 4

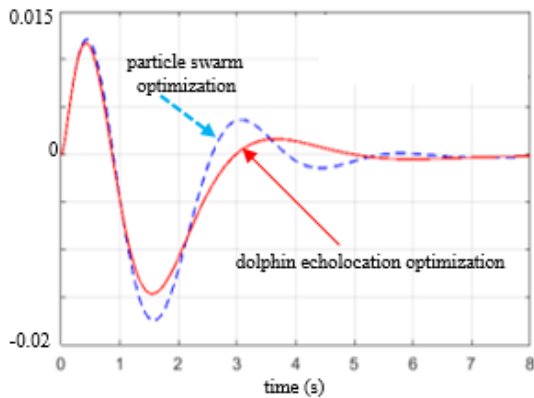

Fig. 16. Response speed changes with independent controller (UPFC-POD only)

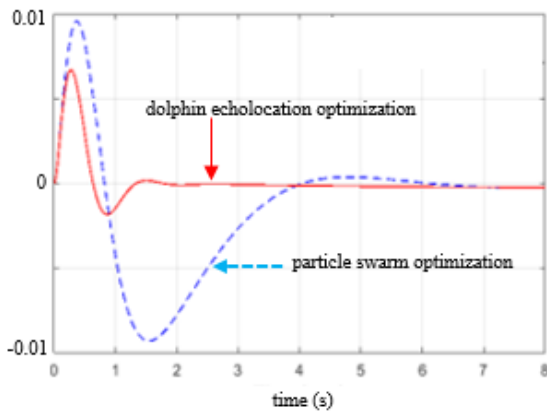

Fig. 17. Response speed changes with controllers (PSS and UPFC-simultaneous)

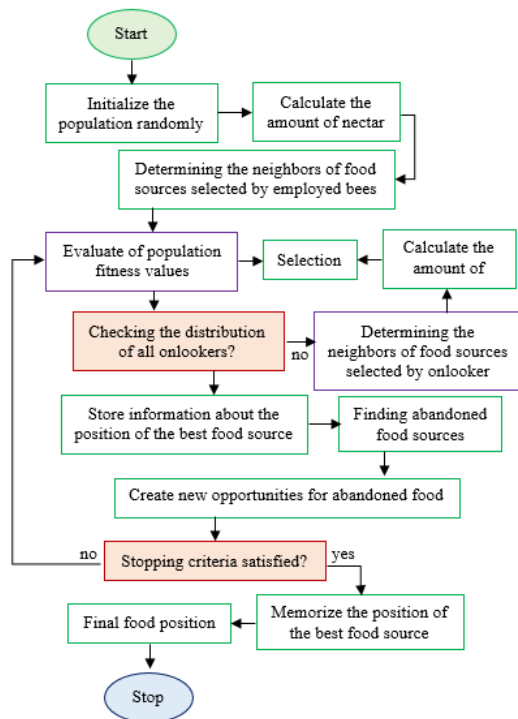

Fig. 18. A view of the ABC algorithm process

To coordinate between STATCOM and PSS to improve the better damping of electromechanical oscillations, the ABC algorithm is employed in [27], and the outcomes are analyzed with the PSO strategy. The simulation results in a two-area four-machine system show the advancement of electromechanical oscillation damping in the area and inter-area modes using the ABC technique compared to the PSO strategy.

The application of ABC algorithm in PSS design with TCSC-based controller to improve transient stability in a single machine power system is suggested in [28], which simulation results for different loading conditions show the superiority of ABC algorithm in the design of inter-controller coordination. Fig. 17 shows the convergence characteristics of artificial bee colony strategy towards the optimum for different loading conditions including heavy, normal, and light. Fig. 18 shows the rotor angle changes for 5% step changes in load to tuning TCSC parameters in two different algorithms.

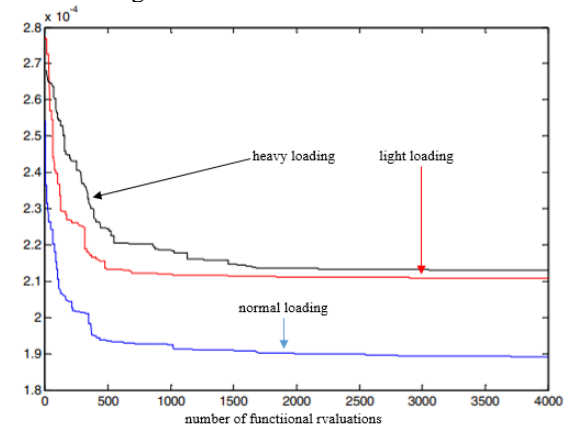

Fig. 19. Convergence features of artificial bee colony algorithm towards optimal for different loading conditions

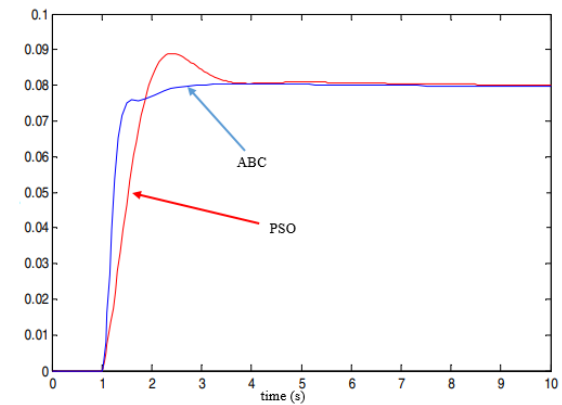

Fig. 20. Rotor angle changes to tuning TCSC parameters in two algorithms

D) Ant Colony Optimization (ACO)

The Ant Colony Algorithm (ACO) is considered as one of the approximate optimization approaches [29,30]. The core concept of this technique is rooted in the indirect local communication that occurs among individuals within an artificial ant colony. The concept of ACO is derived from the empirical study of ant behavior. The fundamental aspect of this significant and intriguing behavior lies in the indirect communication that takes place between ant colonies, enabling them to efficiently navigate between their nests and sources of food [31,32]. The method in question is a probabilistic strategy utilized for the resolution of computer issues. It employs a model-based search approach and bears a resemblance to an estimate of distribution techniques. Fig. 19 depicts the flowchart illustrating the implementation of the algorithm in question [33].

In [34], the use of the ant colony algorithm for coordinating SSSC and PSS controllers on a four-machine system is discussed. The study focuses on the analysis of a three-phase failure in two different scenarios. Subsequently, the obtained simulation outcomes are compared with those obtained using the PSO procedure.

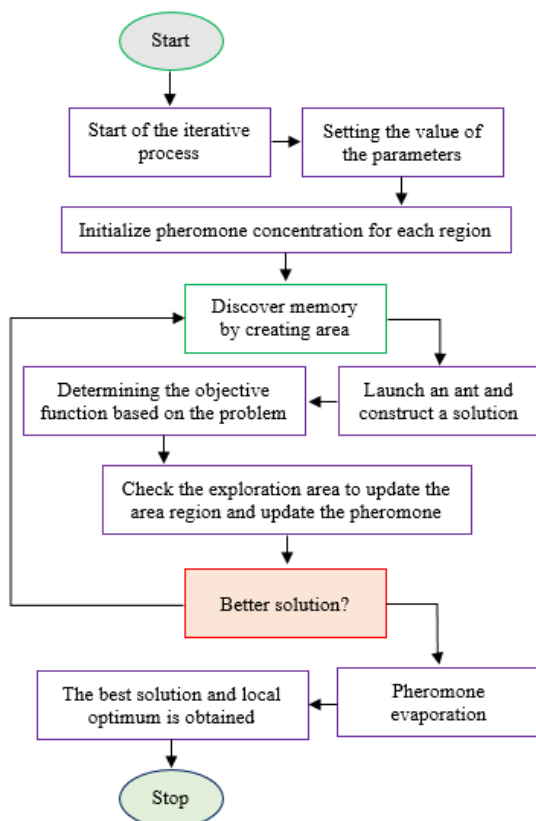

Fig. 21. A view of the ACO algorithm process

E) Cuckoo Search (CS)

The cuckoo optimization algorithm is a collection of meta-heuristic algorithms that draws inspiration from the behavior of cuckoos. It is introduced as a method that begins with an initial population [35,36]. The algorithm is established upon the endeavor of avian species to ensure their survival. It is not uncommon for certain avian species to experience mortality in their pursuit of survival [37,38]. Subsequently, the avian specimens that have been saved embark on a migratory journey to a more favorable habitat, where they commence the process of reproduction by engaging in egg-laying activities. The optimal environment is represented by the highest value attained by the objective functions within the algorithm, as indicated by references [39,40]. Fig. 20 displays the flowchart illustrating the cuckoo optimization technique [41].

The paper [42] presents the utilization of the cuckoo search algorithm for achieving the optimal structure of STATCOM parameter setting in a multi-machine energy system. The comparison between the simulation results and eigenvalues obtained from this method, in conjunction with the genetic algorithm, demonstrates its superior performance in mitigating damping fluctuations and enhancing voltage profiles.

Fig. 21 illustrates the variation of goal functions when utilizing two optimization strategies, namely CS and GA, in the design of STATCOM. It is evident that the objective functions exhibit a drop in value during the iterations of the optimization methods. Furthermore, the convergence speed is observed to be higher in the case of the CS approach, requiring only 53 generations, as opposed to the GA method, which necessitates 72 generations. The authors of reference [43] present a computer science program that aims to achieve the best design of PSS in a energy system with many machines. The algorithm focuses on solving the optimization problem related to determining the appropriate parameters for the stabilizers.

The determination of the objective function also takes into account the eigenvalues associated with electromechanical modes exhibiting low damping. Fig. 22 illustrates the angular velocity (expressed in radians per second) reaction between machines 2 and 3 within the power system when subjected to high load conditions. The CS approach has demonstrated efficacy in diminishing settling time and mitigating power system oscillations. Additionally, the mean settling time of oscillations for the three approaches, namely CS, GA, and conventional PSS, is recorded as 1.0, 1.43, and 5.3 seconds, respectively.

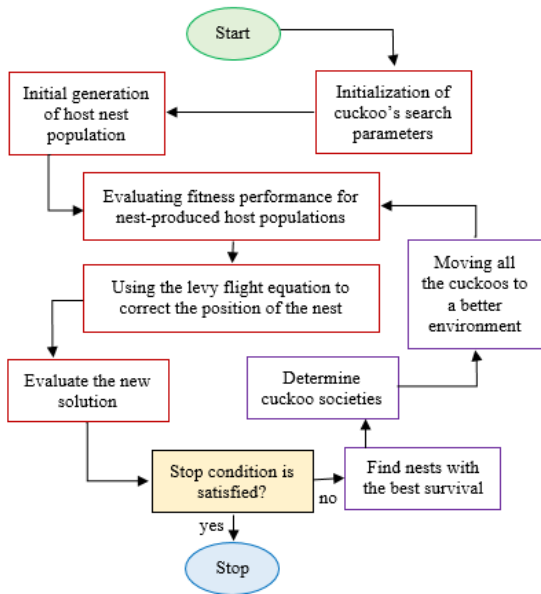

Fig. 22. Cuckoo optimization algorithm flowchart

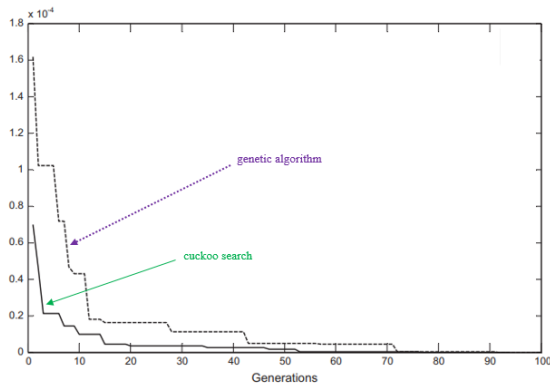

Fig. 23. Comparison of objective function changes in two optimization methods

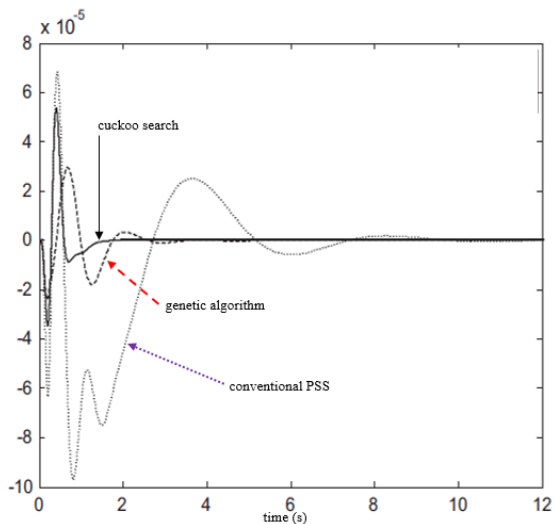

Fig. 24. Change in speed between machines 2 and 3 under heavy load

F) Bat Algorithm (BA)

This method has been utilized to optimize various objectives, which can be mentioned tuning the PSS to increase small signal stability [44].

G) Hybrid Algorithm

Hybrid algorithms are commonly employed to address the limitations inherent in optimization strategy when tackling optimization problems [45,46]. The integration of many methodologies enables the utilization of the respective benefits in the development of the regulator [47,48].

Fig. 23 depicts the flowchart illustrating an instance of the integration of the gravitational search algorithm and particle swarm optimization methods. It is evident that the hybrid method commences with random initialization and ultimately fulfills the requirements pertaining to the velocity and location of the final criterion [49].

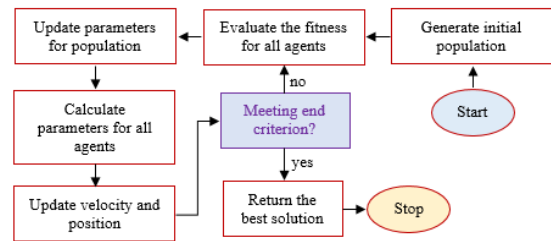

Fig. 25. Flowchart of a hybrid algorithm based on two optimization methods

In [50], the utilization of STATCOM, supplementary POD, and PSS is implemented to enhance the stability of power systems within the transmission grid. This involves the optimization of controller parameters through the application of an advanced intelligent optimization algorithm, specifically the hybrid PSO and GA algorithm, which effectively addresses the issue of local convergence in PSO.

In addition, the objective function encompasses voltage control and STATCOM damping control as means to mitigate the Low-Frequency Oscillation (LFO). In order to mitigate the occurrence of low frequency oscillations within a energy system, a novel approach is presented in reference [51]. This approach involves the utilization of an interval type-2 fractional order fuzzy proportional integral derivative-PS), where the input signals taken into account are speed deviation and acceleration.

In addition, a strategy that combines the firefly algorithm with particle swarm optimization is used to optimize the coefficients. The authors of reference [52] have presented a novel approach that utilizes a combination of continuous wavelet transform and the Prony algorithm for the

coordinated optimization of UPFC and PSS parameters. The objective of this strategy is to mitigate low-frequency electromechanical oscillations in the power system.

The multi-objective optimization problem is addressed by employing the Improving the Strength Pareto Evolutionary Algorithm. Additionally, the hysteresis approach is employed to enhance damping and ensure compliance with power system controller limitations. In a study conducted by [53], an examination was conducted on the effectiveness of two controllers, namely STATCOM and PSS, in enhancing transient stability and small signal stability in wind energy systems.

The study utilized a genetic algorithm to optimize the coefficients of the regulators. The optimization of parameters in transient stability has been explored through the use of three distinct methods: grey wolf optimization (GWO), PSO, and GA. A comparative analysis has been conducted to evaluate the implementation of these techniques. Fig. 24 compares the convergence of three optimization strategies for the same objective function and restrictions.

The convergence of GWO, PSO, and GA to a value of 109.138 is noted. Figs. 25 and 26 depict the transient response of the active power of a wind farm based on a double-fed induction generator, as well as the rotor angle of the synchronous generator, for design parameters, utilizing the three optimization techniques mentioned. The outcomes demonstrate that the implementation of the design with the GA method had a more pronounced impact on mitigating fluctuations compared to the other two methods.

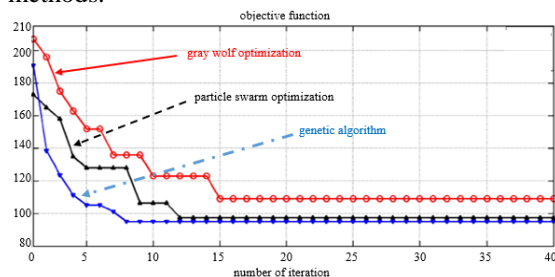

Fig. 26. Comparison of convergence between three optimization methods

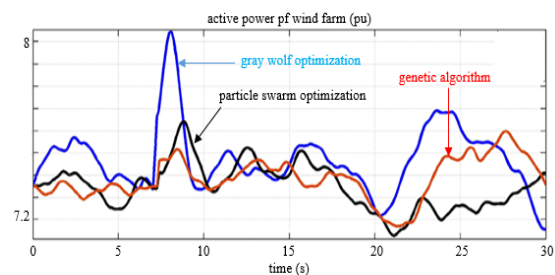

Fig. 27. Transient response of active power flow of DFIG-based wind farm

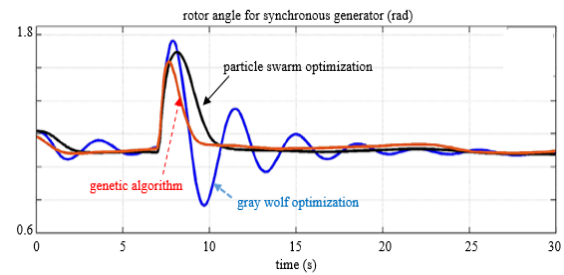

Fig. 28. Transient response of rotor angle of synchronous generator

5. Conclusion

Oscillations within linked power networks can have a substantial impact on the coordination among system generators, resulting in disruptions in power transmission and stability concerns. The effective transmission of electricity by the power system can be constrained by low-frequency variations. In order to tackle these issues, FACTS and PSS devices are utilized to improve stability and mitigate power system oscillations. This paper provides a succinct overview of the utilization of different optimization algorithms, specifically Genetic Algorithm (GA), Artificial Bee Colony (ABC), Particle Swarm Optimisation (PSO), Cuckoo Search (CS), Ant Colony Optimisation (ACO), and Bat Algorithm (BA), in the development of coordination between PSS and FACTS regulators.

References

- [1] A. Hussein Sachit, B. Fani, M. Delshad, G. Shahgholian, A. Golsorkhi Esfahani, "Analysis and implementation of second-order step-up converter using winding coupled inductors for photovoltaic applications", *Journal of Solar Energy Research*, vol. 8, no. 2, pp. 1516-1525, April 2023, doi: 10.22059/jser.2023.357285.1291.
- [2] M. Fooladgar, E. Rok-Rok, B. Fani, G. Shahgholian, "Evaluation of the trajectory sensitivity analysis of the DFIG control parameters in response to changes in wind speed and the line impedance connection to the grid DFIG", *Journal of Intelligent Procedures in Electrical Technology*, Vol. 5, No. 20, pp. 37-54, March 2015, dor: 20.1001.1.23223871.1393.5.20.4.9.
- [3] S.H. Mozafarpour-Khoshrodi, G. Shahgholian, "Improvement of perturb and observe method for maximum power point tracking in wind energy conversion system using fuzzy controller", *Energy Equipment and Systems*, vol. 4, no. 2, pp. 111-122, Dec. 2016, doi: 10.22059/EES.2016.23031.
- [4] M. Kamali, B. Fani, G. Shahgholian, G.B. Gharehpetian, M. Shafiee, "Harmonic compensation and micro-grid voltage and frequency control based on power proportional distribution with adaptive virtual impedance method", *Journal of Intelligent Procedures in Electrical Technology*, vol. 14, no. 53, pp. 33-60, June 2023, dor: 20.1001.1.2322-3871.1402.14.53.3.7.
- [5] S.M. Behinnezhad, G. Shahgholian, B. Fani, "Simulation of a PV connected to an electrical energy distribution network with internal current loop control and voltage regulator", *International Journal of Smart Electrical Engineering*, vol. 12, no. 1, pp. 23-30, Feb. 2023, doi: 10.30495/ijsee.20-21.685745.

- [6] H. Fayazi, M. Moazzami, B. Fani, G. Shahgholian, "Coordination of protection equipment in synchronous generator-based microgrids with regard to maintaining first swing stability", *Journal of Intelligent Procedures in Electrical Technology*, vol. 14, no. 53, pp. 1-14, June 2023, doi: 20.1001.1.23223871.1402.14.54.2.8.
- [7] B. Keyvani, B. Fani, H. Karimi, M. Moazzami, G. Shahgholian, "Improved droop control method for reactive power sharing in autonomous microgrids", *Journal of Renewable Energy and Environment*, vol. 9, no. 3, pp. 1-9, Sept. 2022, doi: 10.30501/jree.2021.298138.1235.
- [8] A. Khosravi, A. Chatraei, G. Shahgholian, S.M. Kargar, "A review of surge control and modeling in centrifugal compressors", *Journal of Intelligent Procedures in Electrical Technology*, vol. 13, no. 50, pp. 1-30, Sept. 2022, doi: 20.1001.1.23223871.1401.13.50.1.2.
- [9] D. Taheri, G. Shahgholian, M.M. Mirtalaei, "Analysis, design and implementation of a high step-up multi-port non-isolated converter with coupled inductor and soft switching for photovoltaic applications", *IET Generation, Transmission and Distribution*, vol. 16, no. 17, pp. 3473-3497, Sept. 2022, doi: 10.1049/gtd2.12537.
- [10] F. Mohammadzamani, M. Hashemi, G. Shahgholian, "Adaptive neural control of non-linear fractional order multi-agent systems in the presence of error constraints and input saturation", *IET Control Theory and Applications*, vol. 16, no. 13, pp. 1283-1298, Sept. 2022, doi: 10.1049/cth2.12291.
- [11] E. Hosseini, G. Shahgholian, H. Mahdavi-Nasab, F. Mesrinejad, "Variable speed wind turbine pitch angle control using three-term fuzzy controller", *International Journal of Smart Electrical Engineering*, vol. 11, no. 2, pp. 63-70, June 2022, doi: 20.1001.1.22519246.2022.11.0-2.2.0.
- [12] A. Fattollahi, G. Shahgholian, B. Fani, "Decentralized synergistic control of multi-machine power system using power system stabilizer", *Signal Processing and Renewable Energy*, vol. 4, no. 4, pp. 1-21, Dec. 2020, doi: 20.1001.1.25887327.2020.4.4.1.9.
- [13] G. Shahgholian, M. Maghsoodi, M. Mahdavian, S. Farazpey, M. Janghorbani and M. Azadeh, "Design of fuzzy+PI controller in application of TCSC and PSS for power system stability improvement", *Proceeding of the IEEE/ECTI-CON*, pp. 1-6, Chiang Mai, Thailand, June/July 2016, doi: 10.1109/ECTICon.2016.7560908.
- [14] S. Ahmadi, I. Sadeghkhan, G. Shahgholian, B. Fani, J. M. Guerrero, "Protection of LVDC microgrids in grid-connected and islanded modes using bifurcation theory", *IEEE Journal of Emerging and Selected Topics in Power Electronics*, vol. 9, no. 3, pp. 1-8, June 2021, doi: 10.1109/JESTPE.2019.2961903.
- [15] O. Sharifiyana, M. Deghani, G. Shahgholian, S.M.M. Mirtalaei, "Presenting a new high gain boost converter with inductive coupling energy recovery snubber for renewable energy systems- simulation, design and construction", *Journal of Solar Energy Research*, vol. 8, no. 2, pp. 1417-1436, April 2023, doi: 10.22059/jsr.2023.356571.1283.
- [16] O. Sharifiyana, M. Deghani, G. Shahgholian, S.M.M. Mirtalaei, M. Jabbari, "Non-isolated boost converter with new active snubber structure and energy recovery capability", *Journal of Circuits, Systems and Computers*, vol. 32, no. 5, Article Number: 2350084, March 2023, doi: 10.1142/S0218126623500846.
- [17] G. Shahgholian, K. Khani, M. Moazzami, "Frequency control in autonomous microgrid in the presence of DFIG based wind turbine", *Journal of Intelligent Procedures in Electrical Technology*, Vol. 6, No. 23, pp. 3-12, December 2015, doi: 20.1001.1.23223871.1394.6.23.1.9.
- [18] M. Hashemi, G. Shahgholian, "Distributed robust adaptive control of high order nonlinear multi agent systems", *ISA Transactions*, vol. 74, pp. 14-27, March 2018, doi: 10.1016/j.isatra.2018.01.023.
- [19] M. Tavoosi, B. Fani, E. Adib, "Stability analysis and control of dfig based wind turbine using FBC strategy", *Journal of Intelligent Procedures in Electrical Technology*, vol. 4, no. 15, pp. 31-42, Nov. 2013, doi: 20.1001.1.23223871.139-2.4.15.4.2.
- [20] J. Faiz, G. Shahgholian, M. Ehsan, "Modeling and simulation of the single phase voltage source UPS inverter with fourth order output filter", *Journal of Intelligent Procedures in Electrical Technology*, vol. 1, no. 4, pp. 63-58, Feb. 2011, doi: 20.1001.1.23223871.1389.1.4.8.3.
- [21] R. Sadiq, Z. Wang, C.Y. Chung, C. Zhou, C. Wang, "A review of STATCOM control for stability enhancement of power systems with wind/PV penetration: Existing research and future scope", *International Transactions on Electrical Energy Systems*, vol. 31, no. 11, Article Number: e13079, Nov. 2021, doi: 10.1002/2050-7038.13079.
- [22] J. Faiz, G. Shahgholian, M. Ehsan, "Stability analysis and simulation of a single-phase voltage source UPS inverter with two-stage cascade output filter", *European Transactions on Electrical Power*, vol. 18, no. 1, pp. 29-49, Jan. 2008, doi: 10.1002/etep.160.
- [23] H. Chojaa, A. Derouich, S.E. Chehaidia, O. Zamzoum, M. Taoussi, H. Elouatouat, "Integral sliding mode control for DFIG based WECS with MPPT based on artificial neural network under a real wind profile", *Energy Reports*, vol. 7, pp. 4809-4824, Nov. 2021, doi: 10.1016/j.egyr.2021.07.066.
- [24] H. Lotfi, R. Ghazi, "Optimal participation of demand response aggregators in reconfigurable distribution system considering photovoltaic and storage units", *Journal of Ambient Intelligence and Humanized Computing*, vol. 12, no. 2, pp. 2233-2223, Feb. 2021, doi: 10.1007/s12652-020-02322-2.
- [25] L. Swarupa, S. Lakshmi, O. Rubanenko, D. Danylchenko, "Modeling, simulation and simultaneous tuning employing genetic algorithm in power system with power system stabilizer with TCSC controller", *Proceeding of the IEEE/KhPIWeek*, pp. 1-5, Kharkiv, Ukraine, Oct. 2022, doi: 10.1109/KhPIWeek57572.2022.9916504.
- [26] Z. Ni, Y. Tang, X. Sui, H. He, J. Wen, "An adaptive neuro-control approach for multi-machine power systems", *International Journal of Electrical Power and Energy Systems*, vol. 75, pp. 108-116, Feb. 2016, doi: 10.1016/j.jepes.2015.08.012.
- [27] F. Mohammadzamani, M. Hashemi, G. Shahgholian, "Adaptive control of nonlinear time delay systems in the presence of output constraints and actuator's faults", *International Journal of Control*, vol. 96, no. 3, pp. 541-553, March 2023, doi: 10.1080/00207179.2021.2005257.
- [28] G. Shahgholian, P. Shafaghi, "State space modeling and eigenvalue analysis of the permanent magnet DC motor drive system", *Proceeding of the IEEE/ICECT*, pp. 63-67, Kuala Lumpur, Malaysia, May 2010, doi: 10.1109/ICECTECH.2010.5479987.
- [29] N. Jankovic, J. Roldan-Perez, M. Prodanovic, J.A. Suul, S. D'Arco, L.R. Rodriguez, "Power oscillation damping method suitable for network reconfigurations based on converter interfaced generation and combined use of active and reactive powers", *International Journal of Electrical Power and Energy Systems*, vol. 149, Article Number: 109010, July 2023, doi: 10.1016/j.jepes.2023.109010.
- [30] A. Farah, T. Guesmi, H.H. Abdallah, "A new method for the coordinated design of power system damping controllers", *Engineering Applications of Artificial Intelligence*, vol. 64, pp. 325-339, Sept. 2017, doi: 10.1016/j.engappai.2017.06.010.
- [31] M.J. Morshed, A. Fekih, "A probabilistic robust coordinated approach to stabilize power oscillations in

- DFIG-based power systems", *IEEE Trans. on Industrial Informatics*, vol. 15, no. 10, pp. 5599-5612, Oct. 2019, doi: 10.1109/TII.2019.2901935.
- [32] M. Hamzeh, M. Ghafouri, H. Karimi, K. Sheshyekani, J.M. Guerrero, "Power oscillations damping in dc microgrids", *IEEE Trans. on Energy Conversion*, vol. 31, no. 3, pp. 970-980, Sept. 2016, doi: 10.1109/TEC.2016.2542266.
- [33] T. Surinkaew, R. Shah, M. Nadarajah, S.M. Mueyeen, "Forced oscillation damping controller for an interconnected power system", *IET Generation, Transmission and Distribution*, vol. 14, no. 2, pp. 339-347, Jan. 2020, doi: 10.1049/iet-gtd.2019.1115.
- [34] T. Hiyama, M. Mishiro, H. Kihara, T.H. Ortmeier, "Coordinated fuzzy logic control for series capacitor modules and PSS to enhance stability of power system", *IEEE Trans. on Power Delivery*, vol. 10, no. 2, pp. 1098-1104, April 1995, doi: 10.1109/61.4-00877.
- [35] A.H.M. Isfahani, M. Reiszadeh, S.Y. Koupaye, M. Honarmand, "Empirical correlations and an artificial neural network approach to estimate saturated vapor pressure of refrigerants", *Physical Chemistry Research*, vol. 5, no. 2, pp. 281-292, June 2017, doi: 10.22036/pcr.2017.41111.
- [36] A. Pourkhalili, S.M.A. Zanjani, "Design of a two-stage operational amplifier using artificial neural network", *Journal of Intelligent Procedures in Electrical Technology*, vol. 15, no. 58, pp. 143-159, Sept. 2024, doi: 10.1001.1.23223871.1403.15.58.10.1.
- [37] G.H. Hwang, D.W. Kim, J.H. Lee, Y.J. An, "Design of fuzzy power system stabilizer using adaptive evolutionary algorithm", *Engineering Applications of Artificial Intelligence*, vol. 21, no. 1, pp. 86-96, Feb. 2008, doi: 10.1016/j.eng-appai.2006.11.008.
- [38] E. Aghadavoodi, G. Shahgholian, "A new practical feed-forward cascade analyze for close loop identification of combustion control loop system through RANFIS and NARX", *Applied Thermal Engineering*, vol. 133, pp. 381-395, March 2018, doi: 10.1016/j.applthermaleng.2018.01.075.
- [39] M.R. Djalal, I. Robandi, M.A. Prakasa, "Stability enhancement of sulselrabar electricity system using mayfly algorithm based on static var compensator and multi-band power system stabilizer PSS2B", *IEEE Access*, vol. 11, pp. 57319-57340, June 2023, doi: 10.1109/ACCESS.2023.3283598.
- [40] D. Butti, S.K. Mangipudi, S.R. Rayapudi, "An improved whale optimization algorithm for the design of multi-machine power system stabilizer", *International Transactions on Electrical Energy Systems*, vol. 30, no. 5, Article Number: e12314, May 2020, doi: 10.1002/2050-7038.12314.
- [41] S. Gorji, S. Zamanian, M. Moazzami, "Techno-economic and environmental base approach for optimal energy management of microgrids using crow search algorithm", *Journal of Intelligent Procedures in Electrical Technology*, vol. 11, no. 43, pp. 49-68, Oct. 2020, doi:10.1001.1.23223871.1399.11.43.4.7.
- [42] R. Devarapalli, B. Bhattacharyya, "A hybrid modified grey wolf optimization-sine cosine algorithm-base-d power system stabilizer parameter tuning in a multimachine power system", *Optimal Control Applications and Methods*, vol. 41, no. 4, pp. 1143-1159, July/Aug. 2020, doi: 10.1002/oca.2591.
- [43] A. Khodabakhshian, E. Daryabeigi, M. Moazzami, "A new optimization approach for multi-machine power system stabilizer design using a smart bacteria foraging algorithm", *Simulation*, vol. 89, no. 9, pp. 1041-1055, July 2013, doi: /10.1177/0037549713495741.
- [44] J. Ahmed, Z. Salam, "A maximum power point tracking (MPPT) for PV system using cuckoo search with partial shading capability", *Applied Energy*, vol. 119, pp. 118-130, April 2014, doi: 10.1016/j.apenergy.2013.12.062.
- [45] B. Dasu, M.S. Kumar, R.S. Rao, "Design of robust modified power system stabilizer for dynamic stability improvement using particle swarm optimization technique", *Ain Shams Engineering Journal*, vol. 10, no. 4, pp. 769-783, Dec. 2019, doi:10.1016/j.asej.2019.07.002.
- [46] D.U. Sarkar, T. Prakash, "A recent review on approaches to design power system stabilizers: Status, challenges and future scope", *IEEE Access*, vol. 11, pp. 34044-34061, Feb. 2023, doi: 10.1109/ACCESS.2023.3244687.
- [47] S.M. Abd-Elazim, E.S. Ali, "A hybrid particle swarm optimization and bacterial foraging for optimal power system stabilizers design", *International Journal of Electrical Power and Energy Systems*, vol. 46, pp. 334-341, March 2013, doi: 10.1016/j.ijepes.2012.10.047.
- [48] R. Hemmati, "Power system stabilizer design based on optimal model reference adaptive system", *Ain Shams Engineering Journal*, vol. 9, no. 2, pp. 311-318, 2018, doi: 10.1016/j.asej.2016.03.002.
- [49] D. Chitara, K.R. Niazi, A. Swarnkar, N. Gupta, "Cuckoo search optimization algorithm for designing of a multimachine power system stabilizer", *IEEE Trans. on Industry Applications*, vol. 54, no. 4, pp. 3056-3065, July/Aug. 2018, doi: 10.1109/TIA.2018.2811725.
- [50] G. Shahgholian, A. Rajabi, B. Karimi, "Analysis and design of PSS for multi-machine power system based on sliding mode control theory", *International Review of Electrical Engineering*, vol. 4, no. 2, Oct. 2010.
- [51] G. Shahgholian Ghfarokhi, M. Arezoomand, H. Mahmoodian, "Analysis and simulation of the single-machine infinite-bus with power system stabilizer and parameters variation effects", *Proceeding of the IEEE/ICIAS, Kuala Lumpur, Malaysia*, pp. 167-171, Nov. 2007, doi: 10.1109/ICIAS.2007.4658368.
- [52] G. Shahgholian, A. Rajabi, B. Karimi, M. Yousefi, "Design of power system stabilizer based on sliding mode control theory for multi-machine power system", *Journal of Intelligent Procedures in Electrical Technology*, vol. 1, no. 1, pp. 13-22, Feb. 2010, doi: 10.1001.1.23223871.1389.1.1.2.1.
- [53] J. Bhukya, V. Mahajan, "Mathematical modelling and stability analysis of PSS for damping LFOs of wind power system", *IET Renewable Power Generation*, vol. 13, no. 1, pp. 103-115, Jan. 2019, doi: 10.1049/iet-rpg.2018.5555.
- [54] A. Fattollahi, M. Dehghani, MR Yousefi, "Analysis and simulation dynamic behavior of power system equipped with PSS and excitation system stabilizer", *Signal Processing and Renewable Energy*, vol. 6, no. 1, pp. 99-111, March 2022, doi: 10.1001.1.25887327.2022.6.1.6.2.
- [55] M. Cloughley, K.M. Muttaqi, H. Du, "Damping of low-inertia machine oscillations using takagi-sugeno fuzzy stabiliser tuned by genetic algorithm optimisation to improve system stability", *IET Generation, Transmission and Distribution*, vol. 8, no. 2, pp. 339-52, Feb. 2014, doi: 10.1049/iet-gtd.2012.0746.
- [56] M.A. El-Dabah, M.H. Hassan, S. Kamel, M.A. Abido, H.M. Zawbaa, "Optimal tuning of power system stabilizers for a multi-machine power systems using hybrid gorilla troops and gradient-based optimizers", *IEEE Access*, vol. 11, pp. 27168-27188, Feb. 2023, doi: 10.1109/ACCESS.2023.3250384.
- [57] S. Chusanapiputt, D. Nualhong, S. Phoomvuthisarn, "Hybrid RBF neural network adaptive optimal power system stabilizer with Tabu search", *Proceeding of the IEEE/ICPST*, vol. 1, pp. 355-360, Kunming, China, Oct. 2002, doi: 10.1109/ICPST.2002.1053565.
- [58] P.R. Nakhi, M.A. Kamarposhti, "Multi objective design of type II fuzzy based power system stabilizer for power system with wind farm turbine considering uncertainty",

- International Transactions on Electrical Energy Systems, vol. 30, no. 4, Article Number: e12285, April 2020, doi: 10.1002/2050-7038.12285.
- [59] Z. Bouchama, N. Essounbouli, M.N. Harmas, A. Hamzaoui, K. Saoudi, "Reaching phase free adaptive fuzzy synergetic power system stabilizer", International Journal of Electrical Power and Energy Systems, vol. 77, pp. 43-49, May 2016, doi: 10.1016/j.ijepes.2015.11.017.
- [60] L.H. Hassan, M. Moghavvemi, H.A.F. Mohamed, "Power system stabilization based on artificial intelligent techniques; A review", Proceeding of the IEEE/TECHPOS, pp. 1-6, Kuala Lumpur, Malaysia, Dec. 2009, doi: 10.1109/TECHPOS.2009.5412107.
- [61] A. Mahabuba, M.A. Khan, "Small signal stability enhancement of a multi-machine power system using robust and adaptive fuzzy neural network-based power system stabilizer", European Transactions on Electrical Power, vol. 19, no. 7, pp. 978-1001, Oct. 2009, doi: 10.1002/etep.276.
- [62] Y.Y. Hsu, C.R. Chen, "Tuning of power system stabilizers using an artificial neural network", IEEE Trans. on Energy Conversion, vol. 6, no. 4, pp. 612-619, Dec. 1991, doi: 10.1109/60.103633.
- [63] Y. Zhang, O.P. Malik, G.P. Chen, "Artificial neural network power system stabilizers in multi-machine power system environment", IEEE Trans. on Energy Conversion, vol. 10, no. 1, pp. 147-155, March 1995, doi: 10.1109/60.372580.
- [64] J. He, O.P. Malik, "An adaptive power system stabilizer based on recurrent neural networks", IEEE Trans. on Energy Conversion, vol. 12, no. 4, pp. 413-418, Dec. 1997, doi: 10.1109/60.638966.
- [65] S. Zanjani, Z. Azimi, M. Azimi, "Assesment and analyze hybride control system in distribution static synchronous compensator based current source converter", Journal of Intelligent Procedures in Electrical Technology, vol. 2, no. 7, pp. 59-67, December 2011, dor: 20.1001.1.23223871.1390.2.7.7.5.
- [66] A.A. Motiebirjandi, D. Fateh, "Optimal placement method of multi UPFCs to damp power system oscillations", International Transactions on Electrical Energy Systems, vol. 27, no. 9, Article Number: e2360, Sept. 2017, doi: 10.1002/etep.2360B.
- [67] S. Ghasemi, E. Gholipoor, "Reactive power optimization in the presence of FACTS devices using evolutionary algorithms based on fuzzy logic", Journal of Intelligent Procedures in Electrical Technology, vol. 6, no. 23, pp. 45-54, Nov. 2015, dor: 20.1001.1.23223871.1394.6.23.6.4.
- [68] A. Kargarian, M. Rahmani, "Multi-microgrid energy systems operation incorporating distribution-interline power flow controller", Electric Power Systems Research, vol. 129, pp. 208-216, Dec. 2015, doi: 10.1016/j.epsr.2015.08.015.
- [69] G. Shahgholian, "A brief overview of microgrid performance improvements using distributed FACTS devices", Journal of Renewable Energy and Environment, vol. 10, no. 1, pp. 43-58, Jan. 2023, doi: 10.30501/jree.2022.321435.1305.
- [70] M. Alilou, S. Sadi, S. Zamanian, J. Gholami, S. Moshari, "Improving the efficiency of actual distribution system by allocating multi-DG and DSTATCOM", Journal of Intelligent Procedures in Electrical Technology, vol. 12, no. 45, pp. 1-15, June 2021, dor:20.1001.1.23223871.1400.12.1.1.7.
- [71] N. Taheri, H. Orojlo, H. Karimi, F. Ebrahimi, K. Khalifeh, "Novel adaptive damping controller for interline power flow controller to improve power system stability", International Journal of Smart Electrical Engineering, vol. 10, no. 4, pp. 225-234, Nov. 2021, dor: 20.1001.1.22519246.2021.10.04.7.2.
- [72] G. Shahgholian, E. Haghjou, S. Abazari, "Improving the mitigation of voltage flicker by usage of fuzzy control in a distribution static synchronous compensator (DSTATCOM)", Majlesi Journal of Electrical Engineering, vol. 3, no. 2, pp. 25-35, June 2010, doi: 10.1234/mjee.v3i2.288.
- [73] S. Kamel, F. Jurado, "Power flow analysis with easy modelling of interline power flow controller", Electric Power Systems Research, vol. 108, pp. 234-244, March 2014, doi: 10.1016/j.epsr.2013.11.017.
- [74] A. Motaghi, M. Alizadeh, M. Abbasian, "Reactive power compensation and reducing network transmission losses by optimal placement of parallel and series FACTS devices with fuzzy-evolutionary method", Journal of Intelligent Procedures in Electrical Technology, vol. 9, no. 35, pp. 27-38, Dec. 2019, dor: 20.1001.1.23223871.1397.9.35.4.7.
- [75] G. Shahgholian, P. Shafaghi, S. Moalem, M. Mahdavian, "Analysis and design of a linear quadratic regulator control for static synchronous compensator", Proceeding of the IEEE/ICCEE, pp.65-69, Dubai, Dec. 2009, doi: 10.1109/ICCEE.2009.145.
- [76] G. Shahgholian, P. Shafaghi, S. Moalem, M. Mahdavian, "Damping power system oscillations in single-machine infinite-bus power system using a STATCOM", Proceeding of the IEEE/ICCEE, pp.130-134, Dubai, Dec. 2009, doi: 10.1109/ICCEE.2009.30.
- [77] R. Devarapalli, B. Bhattacharyya, J.K. Saw, "Controller parameter tuning of a single machine infinite bus system with static synchronous compensator using antlion optimization algorithm for the power system stability improvement", Advanced Control for Applications: Engineering and Industrial Systems, vol. 2, no. 3, Article Number: e45, Sept. 2020, doi: 10.1002/adc2.45.
- [78] L. Wang, C.H. Chang, B.L. Kuan, A.V. Prokhorov, "Stability improvement of a two-area power system connected with an integrated onshore and offshore wind farm using a STATCOM", IEEE Trans. on Industry Applications, vol. 53, no. 2, pp. 867-877, March-April 2017, doi: 10.1109/TIA.2016.2628361.
- [79] X. Wu, M. Wang, M. Shahidehpour, S. Feng, X. Chen, "Model-free adaptive control of STATCOM for SSO mitigation in DFIG-based wind farm", IEEE Trans. on Power Systems, vol. 36, no. 6, pp. 5282-5293, Nov. 2021, doi: 10.1109/TPWRS.2021.3082951.
- [80] A. Fathollahi, A. Kargar, S.Y. Derakhshandeh, "Enhancement of power system transient stability and voltage regulation performance with decentralized synergetic TCSC controller", International Journal of Electrical Power and Energy Systems, vol. 135, Article Number: 107533, Feb. 2022, doi: 10.1016/j.ijepes.2021.107533.
- [81] G. Shahgholian, A. Etesami, "The effect of thyristor controlled series compensator on power system oscillation damping control", International Review of Electrical Engineering, Vol. 5, No. 2, pp. 1822-1830, Aug. 2011.
- [82] G. Shahgholian, A. Movahedi, "Coordinated control of TCSC and SVC for system stability enhancement using ANFIS method", International Review on Modelling and Simulations, vol. 4, no. 5, pp. 2367-2375, Oct. 2011.
- [83] Y.Y. Sefidi, R. Asghari, B. Mozafari, M.S. Naderi, "A TCSC control based on stabilizing delay effect for inter-area oscillation damping in a power system with time delay", Signal Processing and Renewable Energy, vol. 3, no. 1, pp. 43-56, March 2019, dor: 20.1001.1.25887327.2019.3.1.4.9.
- [84] A. Fattollahi, "Simultaneous design and simulation of synergetic power system stabilizers and a thyristor-controller series capacitor in multi-machine power systems", Journal of Intelligent Procedures in Electrical

- Technology, vol. 8, no. 30, pp. 3-14, Aug. 2017, doi:20.1001.1.23223871.1396.8.30.1.7.
- [85] A.A.A. Hafez, "STATCOM versus SSSC for power system stabilization", IEEJ Transactions on Electrical and Electronic Engineering, vol. 12, no. 4, pp. 474-483, July 2017, doi: 10.1002/tee.22402.
- [86] E. Gholipour, S.M. Nosratabadi, "A new coordination strategy of SSSC and PSS controllers in power system using SOA algorithm based on pareto method", International Journal of Electrical Power and Energy Systems, vol. 67, pp. 462-471, May 2015, doi:10.1016/j.ijepes.2014.12.020.
- [87] L.L. Sonfack, G. Kenné, A.M. Fombu, "An improved adaptive RBF neuro-sliding mode control strategy: Application to a static synchronous series compensator controlled system", International Transactions on Electrical Energy Systems, vol. 29, no. 5, Article Number: e2835, May 2019, doi: 10.1002/2050-7038.2835.
- [88] P.R. Sahu, P.K. Hota, S. Panda, "Modified whale optimization algorithm for coordinated design of fuzzy lead-lag structure-based SSSC controller and power system stabilizer", International Transactions on Electrical Energy Systems, vol. 29, no. 4, Article Number: e2797, April 2019, doi: 10.1002/etep.2797.
- [89] G. Shahgholian, M. Mahdavian, M. Noorani-Kalteh, M.R. Janghorbani, "Design of a new IPFC-based damping neurocontrol for enhancing stability of a power system using particle swarm optimization", International Journal of Smart Electrical Engineering, vol. 3, no. 2, pp. 73-78, April 2014, doi: 20.1001.1.22519246.2014.03.02.2.4.
- [90] E. Jafari, A. Marjanian, S. Solaymani, G. Shahgholian, "Designing an emotional intelligent controller for IPFC to improve the transient stability based on energy function", Journal of Electrical Engineering and Technology, vol. 8, no. 3, pp. 478-489, 2013, doi: 10.5370/JEET.2013.8.3.478.
- [91] R. Rajbongshi, L.C. Saikia, "Performance of coordinated interline power flow controller and power system stabilizer in combined multiarea restructured ALFC and AVR system", International Transactions on Electrical Energy Systems, vol. 29, no. 5, Article Number: e2822, May 2019, doi: 10.1002/2050-7038.2822.
- [92] E.V. Fortes, P.B. Araujo, L.H. Macedo, B.R. Gamino, L.F.B. Martins, "Analysis of the influence of PSS and IPFC-POD controllers in small-signal stability using a simulated annealing algorithm", Proceeding of the IEEE/INDUSCON, pp. 1-8, Curitiba, PR, Brazil, Nov. 2016, doi: 10.1109/INDUSCON.2016.7874512.
- [93] J. Yuan, S. Xu, H. Chen, C. Zou, Y. Ji, S. Yin, "A novel multilane fast electromagnetic unified power flow controller topology for distribution network", IEEE Trans. on Industry Applications, vol. 58, no. 3, pp. 3238-3249, May/June 2022, doi: 10.1109/TIA.2022.3158373.
- [94] M.R. Esmaili, A. Khodabakhshian, M. Bornapour, "A new coordinated design of UPFC controller and PSS for improvement of power system stability using CPCE algorithm", Proceeding of the IEEE/EPEC, pp. 1-6, Ottawa, ON, Canada, Oct. 2016, doi: 10.1109/EPEC.2016.7771767.
- [95] S. Gandhar, J. Ohri, M. Singh, "Improvement of voltage stability of renewable energy sources-based microgrid using ANFIS-tuned UPFC", Advances in Energy and Built Environment, vol. 36, pp. 133-143, 2020, doi: 10.1007/978-981-13-7557-6_11.
- [96] S. Li, T. Hu, Y. Li, "Reliability improvement to UPFC with routine test to the abnormal state", IEEE Trans. on Power Delivery, vol. 37, no. 6, pp. 4612-4622, Dec. 2022, doi: 10.1109/TPWRD.2022.3152210.
- [97] H. Barati, R. Saki, S. Mortazavi, "Intelligent control of UPFC for enhancing transient stability on multi-machine power systems", Journal of Intelligent Procedures in Electrical Technology, vol. 1, no. 1, pp. 3-12, Feb. 2010, doi: 20.1001.1.23223871.1389.1.1.1.0.
- [98] K.M. Kumar Reddy, A.K. Rao, R.S. Rao, "An improved grey wolf algorithm for optimal placement of unified power flow controller", Advances in Engineering Software, vol. 173, Article Number: 103187, Nov. 2022, doi: 10.1016/j.advensoft.2022.103187.
- [99] G. Shahgholian, M. Mahdavian, M. Janghorbani, I. Eshaghpour, E. Ganji, "Analysis and simulation of UPFC in electrical power system for power flow control", Proceeding of the IEEE/ECTICON, pp. 62-65, Phuket, Thailand, June 2017, doi: 10.1109/ECTICon.2017.8096173.
- [100] A. Kazemi-Zahrani, M. Parastegari, "Designing PSS and SVC parameters simultaneously through the improved quantum algorithm in the multi-machine power system", Journal of Intelligent Procedures in Electrical Technology, vol. 8, no. 31, pp. 68-75, Nov. 2017, doi: 20.1001.1.23223871.1396.8.31.6.4.
- [101] A. Mishra, V.N.K. Gundavarapu, "Line utilisation factor-based optimal allocation of IPFC and sizing using firefly algorithm for congestion management", IET Generation, Transmission and Distribution, vol. 10, no. 1, pp. 115-122, Jan. 2016.
- [102] A. Salgotra, S. Pan, "A frequency domain model-based design of PSS and TCSC controller for damping the small signal oscillations in the power system", International Transactions on Electrical Energy Systems, vol. 29, no. 3, Article Number: e2742, Oct. 2018, doi: 10.1002/etep.2742.
- [103] G. Yu, T. Lin, J. Zhang, Y. Tian and X. Yang, "Coordination of PSS and FACTS damping controllers to improve small signal stability of large-scale power systems", CSEE Journal of Power and Energy Systems, vol. 5, no. 4, pp. 507-514, Dec. 2019, doi: 10.17775/CSEEJPES.2018.00530.
- [104] M. Karimi, H. Pourghassem, G. Shahgholian, "A novel prosthetic hand control approach based on genetic algorithm and wavelet transform features", Proceeding of the IEEE/CSPA, pp. 287-292, Penang, Malaysia, March 2011, doi: 10.1109/CSPA.2011.5759889.
- [105] S. Tuo, H. Chen, H. Liu, "A survey on swarm intelligence search methods dedicated to detection of high-order SNP interactions", IEEE Access, vol. 7, pp. 162229-162244, Nov. 2019, doi: 10.1109/ACCESS.2019.2951700.
- [106] Y.L. Abdel-Magid, M.M. Dawoud, "Tuning of power system stabilizers using genetic algorithms", Electric Power Systems Research, vol. 39, no. 2, pp. 137-143, Nov. 1996, doi: 10.1016/S0378-7796(96)01105-4.
- [107] L.H. Hassan, M. Moghavvemi, H.A.F. Almurib, K.M. Muttaqi, "A coordinated design of PSSs and UPFC-based stabilizer using genetic algorithm", IEEE Trans. on Industry Applications, vol. 50, no. 5, pp. 2957-2966, Sept./Oct. 2014, doi: 10.1109/TIA.2014.2305797.
- [108] H.R. Jariwala, A. Chowdhury, "Design of PID-PSS and SVC in a multi-machine system for damping of power system oscillations using genetic algorithm", Proceeding of the IEEE/IICPE, pp. 1-6, Delhi, India, Dec. 2012, doi: 10.1109/IICPE.2012.6450464.
- [109] F. Khajeh-khalili, M.A. Honarvar, "Design and simulation of a wilkinson power divider with high isolation for tri-band operation using PSO algorithm", Journal of Intelligent Procedures in Electrical Technology, vol. 6, no. 23, pp. 13-20, December 2015, doi: 20.1001.1.23223871.1394.6.23.2.0.
- [110] H. Verdejo, V. Pino, W. Kliemann, C. Becker, J. Delpiano, "Implementation of particle swarm optimization (PSO) algorithm for tuning of power system stabilizers in multimachine electric power systems", Energies, vol. 13, no. 8, Article Number: 2093, April 2020, doi:10.3390/en13082093.
- [111] A.A. Sadiq, M. Buhari, S.S. Adamu, H. Musa, "Coordination of multi-type FACTS for available transfer

- capability enhancement using PI-PSO", IET Generation, Transmission and Distribution, vol. 14, no. 21, pp. 4866-4877, Feb. 2020, doi: 10.1049/ie-t-gtd.2020.0886.
- [112] M. Nazarpour, N. Nezafati, S. Shokuhyar, "Detection of attacks and anomalies in the internet of things system using neural networks based on training with PSO and TLBO algorithms", Signal Processing and Renewable Energy, vol. 4, no. 4, pp. 81-94, Dec. 2020, doi: 10.1001.1.25887327.2020.4.4.6.4.
- [113] S. Kiani, R. Tarkesh-Esfahani, Z. Zojaji, "Optimizing the cutting of inconel 718 sheets with co2 laser by particle swarm algorithm", Journal of Intelligent Procedures in Electrical Technology, vol. 13, no. 51, pp. 109-121, December 2022 (in Persian), doi: 10.1001.1.23223871.1401.13.51.7.0.
- [114] R. Borjali-Navesi, D. Nazarpour-Akbari, R. Ghanizadeh, P. Alemi, "Coordination of switchable capacitor banks and dynamic network reconfiguration for the improvement of distribution network operation integrated with renewable energy resources", Journal of Intelligent Procedures in Electrical Technology, vol. 12, no. 48, pp. 43-59, March 2022, doi: 10.1001.1.23223871.1400.12.48.2.2.
- [115] M. Peyvandi, M. Zafarani, E.I. Nasr, "Comparison of particle swarm optimization and the genetic algorithm in the improvement of power system stability by an SSSC-based controller", Journal of Electrical Engineering and Technology, vol. 6, no. 2, March 2011, doi: 10.5370/JEET.2011.6.2.182.
- [116] A.G. Gad, "Particle swarm optimization algorithm and its applications: A systematic review", Archives of Computational Methods in Engineering, vol. 29, pp. 2531-2561, April 2022, doi: 10.1007/s11831-021-09694-4.
- [117] A.A. Alsakati, C.A. Vaithilingam, K. Naidu, G. Rajendran, J. Alnasseir, A. Jagadeeshwaran, "Particle swarm optimization for tuning power system stabilizer towards transient stability improvement in power system network", Proceeding of the IEEE/IICAIET, pp. 1-6, Kota Kinabalu, Malaysia, Sept. 2021, doi: 10.1109/IICAIET51634.2021.9573534.
- [118] S.R. Tuladhar, J.G. Singh, W. Ongsakul, "Multi-objective approach for distribution network reconfiguration with optimal DG power factor using NSPSO", IET Generation, Transmission and Distribution, vol. 10, no. 12, pp. 2842-2851, Sept. 2016, doi: 10.1049/iet-gtd.2015.0587.
- [119] W. Lin, C. Tu, R. Yang, M. Tsai, "Particle swarm optimisation aided least-square support vector machine for load forecast with spikes", IET Generation, Transmission and Distribution, vol. 10, no. 5, pp. 1145-1153, April 2016, doi: 10.1049/iet-gtd.2015.0702.
- [120] S. Panda, N.P. Padhy, "Optimal location and controller design of STATCOM for power system stability improvement using PSO", Journal of the Franklin Institute, vol. 345, no. 2, pp. 166-181, March 2008, doi: 10.1016/j.jfranklin.2007.08.002.
- [121] S. Panda, N.K. Yegireddy, S.K. Mohapatra, "Hybrid BFOA-PSO approach for coordinated design of PSS and SSSC-based controller considering time delays", International Journal of Electrical Power and Energy Systems, vol. 49, pp. 221-233, July 2013, doi: 10.1016/j.ijepes.2013.01.006.
- [122] A. Sabo, N.I.A. Wahab, M.L. Othman, M.Z.A.M. Jaffar, H. Beiranvand, "Optimal design of power system stabilizer for multimachine power system using farmland fertility algorithm", International Transactions on Electrical Energy Systems, vol. 30, no. 12, Article Number: e12657, Dec. 2020, doi: 10.1002/2050-7038.12657.
- [123] G. Shahgholian, A. Movahedi, J. Faiz, "Coordinated design of TCSC and PSS controllers using VURPSO and genetic algorithms for multi-machine power system stability", International Journal of Control, Automation, and Systems, vol. 13, no. 2, pp. 398-409, April 2015, doi: 10.1007/s12555-013-0387-z.
- [124] O.M. Neda, "Optimal coordinated design of PSS and UPFC-POD using DEO algorithm to enhance damping performance", International Journal of Electrical and Computer Engineering, vol. 10, no. 6, pp. 6111-6121, Dec. 2020, doi: 10.11591/ijece.v10i6.pp6111-6121.
- [125] B. Kruekaew, W. Kimpan, "Enhancing of artificial bee colony algorithm for virtual machine scheduling and load balancing problem in cloud computing", International Journal of Computational Intelligence Systems, vol. 13, no. 1, pp. 496 - 510, April 2020, doi: 10.2991/ijcis.d.200410.002.
- [126] A. Bahamsakun, "Artificial bee colony algorithm for content-based image retrieval", Computational Intelligence, vol. 36, no. 1, pp. 351-367, Dec. 2020, doi: 10.1111/coin.12275.
- [127] D. Garg, A. Singhal, "A critical review of artificial bee colony optimizing technique in software testing", Proceeding of the IEEE/ICICCS-INBUSH, pp. 240-244, Greater Noida, India, Feb. 2016, doi: 10.1109/ICICCS.2016.7542311.
- [128] M. Shafiof, N. Behzadfar, "Diagnosis of brain tumor position in magnetic resonance images by combining bounding box algorithms, artificial bee colonies and grow cut", International Journal of Smart Electrical Engineering, vol. 11, no. 1, pp. 1-12, March 2022, doi: 10.1001.1.22519246.2022.11.1.1.7.
- [129] K. Ayan, U. Kılıç, "Artificial bee colony algorithm solution for optimal reactive power flow", Applied Soft Computing, vol. 12, no. 5, pp. 1477-1482, May 2012, doi: 10.1016/j.asoc.2012.01.006.
- [130] A.M. Eltamaly, "An improved cuckoo search algorithm for maximum power point tracking of photovoltaic systems under partial shading conditions", Energies, vol. 14, no. 4, Article Number: 953, Feb. 2021, doi: 10.3390/en14040953.
- [131] D. Karaboga, B. Basturk, "On the performance of artificial bee colony (ABC) algorithm", Applied Soft Computing, vol. 8, no. 1, pp. 687-697, Jan. 2008, doi: 10.1016/j.asoc.2007.05.007.
- [132] Ş. Öztürk, R. Ahmad, N. Akhtar, "Variants of artificial bee colony algorithm and its applications in medical image processing", Applied Soft Computing, vol. 97, Article Number: 106799, Dec. 2020, doi: 10.1016/j.asoc.2020.106799.
- [133] L.L. Dinh, D.V. Ngoc, P. Vasant, "Artificial bee colony algorithm for solving optimal power flow problem", vol. 2013, Article Number: 159040, Dec. 2013, doi: 10.1155/2013/159040.
- [134] A.F. Mohamed, M.M. Elarini, A.M. Othman, "A new technique based on artificial bee colony algorithm for optimal sizing of stand-alone photovoltaic system", Journal of Advanced Research, vol. 5, no. 3, pp. 397-408, May 2014, doi: 10.1016/j.jare.2013.06.010.
- [135] G. Shahgholian, S. Fazeli-Nejad, M. Moazzami, M. Mahdavian, M. Azadeh, M. Janghorbani, S. Farazpey, "Power system oscillations damping by optimal coordinated design between PSS and STATCOM using PSO and ABC algorithms", Proceeding of the IEEE/ECTI-CON, Chiang Mai, Thailand, pp. 1-6, July 2016, doi: 10.1109/ECTICon.2016.7561458.
- [136] B.S. Theja, A. Raviteja, A. Rajasekhar, A. Abraham, "Coordinated design of power system stabilizer using thyristor controlled series compensator controller: An artificial bee colony approach", Proceeding of the IEEE/CSNT, pp. 606-611, Rajkot, Gujarat, India, May 2012, doi: 10.1109/CSNT.2012.136.
- [137] M. Vafaei, A. Khademzadeh, M. A. Pourmina, "A new qos-based routing protocol for video streaming in VANETs using ACO algorithm and fuzzy logic", Journal of

- Intelligent Procedures in Electrical Technology, vol. 12, no. 46, pp. 49-68, Sept. 2021, doi: 20.1001.1.23223871-1400.12.2.4.2.
- [138] S. Zarmahi, S.M. Daneshvar-Farzanegan, A. Avokh, "A new algorithm for link scheduling in MIMO wireless mesh networks with various interference condition by ant colony algorithm", *Journal of Intelligent Procedures in Electrical Technology*, vol. 15, no. 58, pp. 31-44, Sept. 2024, doi: 20.1001.1.23223871.1403.15.58.3.4.
- [139] M.R. Djalal, M. Saini, A.M.S. Yunus, "Optimization power system stabilizer and energy storage using ant colony optimization", *Proceeding of the IEEE/ISMODE*, pp. 120-124, Jakarta, Indonesia, Jan. 2022, doi: 10.1109/ISMODE5-3584.2022.9742761.
- [140] Z. Wang, Z. Hu, X. Yang, "Multi-agent and ant colony optimization for ship integrated power system network reconfiguration", *Journal of Systems Engineering and Electronics*, vol. 33, no. 2, pp. 489-496, April 2022, doi: 10.23919/JSEE.2022.000048.
- [141] F. Vasilyev, S. Virolainen, T. Sainio, "Synthesis of hydrometallurgical processes for valorization of secondary raw materials using ant colony optimization and key performance indicators", *Hydrometallurgy*, vol. 153, pp. 121-133, March 2015, doi: 10.1016/j.hydromet.2015.02.004.
- [142] M.A. Kamarposhti, I. Colak, C. Iwendi, S.S. Band, E. Ibeke, "Optimal coordination of PSS and SSSC controllers in power system using ant colony optimization algorithm", *Journal of Circuits, Systems and Computers*, vol. 31, no. 4, Article Number: 2250060, 2022, doi: 10.1142/S021-8126622500608.
- [143] M. Gheisarnazhad, H. Mojallali, "Fractional order PID controller design for level control of three tank system based on improved cuckoo optimization algorithm", *Journal of Intelligent Procedures in Electrical Technology*, vol. 5, no. 20, pp. 55-66, March 2015, doi: 20.1001.1.2322-3871.1393.5.20.5.0.
- [144] S. Ansari, S. Mohammadi, "Determination of optimal battery capacity in economic operation of micro grid by cuckoo search algorithm", *Journal of Intelligent Procedures in Electrical Technology*, vol. 10, no. 38, pp. 51-64, Aug. 2019, doi: 20.1001.1.23223871.1398.10.38.6.2.
- [145] S.J. Zand, S. Mobayen, H.Z. Gul, H. Molashahi, M. Nasiri, A. Fekih, "Optimized fuzzy controller based on cuckoo optimization algorithm for maximum power-point tracking of photovoltaic systems", *IEEE Access*, vol. 10, pp. 71699-71716, July 2022, doi: 10.1109/ACCESS.2022.3184815.
- [146] M.A. Al-Gabalawy, N.S. Hosny, S.A. Hussien, "Cuckoo search algorithm based for tuning both PI and FOPID controllers for the DFIG-wind energy conversion system", *International Journal of Electrical and Computer Engineering*, vol. 10, no. 6, pp. 2343-2349, Dec. 2020, doi: 10.11591/ijece.v10i6.pp6319-6329.
- [147] R. Teimouri, H. Sohrabpoor, "Application of adaptive neuro-fuzzy inference system and cuckoo optimization algorithm for analyzing electro chemical machining process", *Frontiers of Mechanical Engineering*, vol. 8, no. 4, pp. 929-442, Dec. 2013, doi:10.1007/s11465-013-0277-3.
- [148] M. Shehab, A.T. Khader, M.A. Al-Betar, "A survey on applications and variants of the cuckoo search algorithm", *Applied Soft Computing*, vol. 61, pp. 1041-1059, Dec. 2017, doi: 10.1016/j.asoc.2017.02.034.
- [149] M. Aryanezhad, E. Ostadaghaee, M. Joorabian, "Voltage dip mitigation in wind farms by UPQC based on cuckoo search neuro fuzzy controller", *Proceeding of the IEEE/IFSC*, pp. 1-6, Qazvin, Iran, Aug. 2013, doi: 10.1109/IFSC.2013.6675678.
- [150] S.M. Abd-Elazim, E.S. Ali, "Optimal location of STATCOM in multimachine power system for increasing loadability by cuckoo search algorithm", *International Journal of Electrical Power and Energy Systems*, vol. 80, pp. 240-251, Sept. 2016, doi: 10.1016/j.ijepes.2016.01.023.
- [151] S.M.A. Elazim, E.S. Ali, "Optimal power system stabilizers design via cuckoo search algorithm", *International Journal of Electrical Power and Energy Systems*, vol. 75, pp. 99-107, Feb. 2016, doi: 10.1016/j.ijepes.2015.08.018.
- [152] D.K. Sambariya, R. Prasad, "Robust tuning of power system stabilizer for small signal stability enhancement using metaheuristic bat algorithm", *International Journal of Electrical Power and Energy Systems*, vol. 61, pp. 229-238, Oct. 2014, doi: 10.1016/j.ijepes.2014.03.050.
- [153] L. Zhijian, S. Hongchun, Y. Jilai, "Coordination control between PSS and SVC based on improved genetic - tabu hybrid algorithm", *Proceeding of the IEEE/SUPERGEN*, pp. 1-5, Nanjing, China, April 2009, doi: 10.1109/SUPERGEN.2009.5473877.
- [154] C.F. Lu, C.H. Hsu, C.F. Juang, "Coordinated control of flexible ac transmission system devices using an evolutionary fuzzy lead-lag controller with advanced continuous ant colony optimization", *IEEE Trans. on Power Systems*, vol. 28, no. 1, pp. 385-392, Feb. 2013, doi: 10.1109/TPWRS.2012.2206410.
- [155] H.K. Abdulkhader, J. Jacob, A.T. Mathew, "Fractional-order lead-lag compensator-based multi-band power system stabiliser design using a hybrid dynamic GA-PSO algorithm", *IET Generation, Transmission and Distribution*, vol. 12, no. 13, pp. 3248-3260, May 2018, doi: 10.1049/iet-gtd.2017.1087.
- [156] S. Nasr, H. Mahmoodian, "Insulin drug regulation by general type 2 fuzzy controller with alpha plane", *Journal of Intelligent Procedures in Electrical Technology*, vol. 10, no. 37, pp. 39-48, May 2019, doi: 20.1001.1.232-23871.1398.10.37.4.8.
- [157] R.K. Khadanga, J.K. Satapathy, "Time delay approach for PSS and SSSC based coordinated controller design using hybrid PSO-GSA algorithm", *International Journal of Electrical Power and Energy Systems*, vol. 71, pp. 262-273, Oct. 2015, doi: 10.1016/j.ijepes.2015.03.014.
- [158] P. He, Q. Fang, H. Jin, Y. Ji, Z. Gong, J. Dong, "Coordinated design of PSS and STATCOM-POD based on the GA-PSO algorithm to improve the stability of wind-PV-thermal-bundled power system", *International Journal of Electrical Power and Energy Systems*, vol. 141, Article Number: 108208, Oct. 2022, doi:10.1016/j.ijepes.202-2.108208.
- [159] P.K. Ray, S.R. Paital, A. Mohanty, Y.S.E. Foo, A. Krishnan, H.B. Gooi, G.A. J. Amaratunga, "A hybrid firefly-swarm optimized fractional order interval type-2 fuzzy PID-PSS for transient stability improvement", *IEEE Trans. on Industry Applications*, vol. 55, no. 6, pp. 6486-6498, Nov.-Dec. 2019, doi: 10.1109/TIA.2019.2938473.
- [160] A.H. Naghshbandy, A. Faraji, "Coordinated design of PSS and unified power flow controller using the combination of CWT and prony methods with the help of SPEA II multi-objective optimisation algorithm", *IET Generation, Transmission and Distribution*, vol. 13, no. 21, pp. 4900-4909, Nov. 2019, doi:10.1049/iet-gtd.2018.6605.
- [161] J. Bhukya, V. Mahajan, "Parameter tuning of PSS and STATCOM controllers using genetic algorithm for improvement of small-signal and transient stability of power systems with wind power", *International Transactions on Electrical Energy Systems*, vol. 31, no. 7, Article Number: e12912, July 2021, doi: 10.1002/2050-7038.12912.