

# Comparison of plasticity and stiffness of steel shear walls with composite steel plate shear wall

Leila Shahryari<sup>\*a</sup>, Mahdi Esfandiari<sup>b</sup>

<sup>a</sup>PhD of Civil Engineering-Structure, Faculty member. A. Department of Civil Engineering, Shiraz Branch, Islamic Azad University, Shiraz, Iran.

<sup>b</sup>MS of Civil Engineering-Structure. A. Department of Civil Engineering, Shiraz Branch, Islamic Azad University Shiraz, Iran.

Received 1 June, 2015; Accepted 29 August 2015

## Abstract

The steel shear wall and composite steel plate shear wall is introduced in recent three decade and is considered and is spread rapidly. Composite steel plate shear wall which is made of a layer of thin steel sheet with coating of reinforced concrete in one or both sides of steel palate is considered a third generation of resistance shear walls against lateral loads that in addition to increasing the strength, ductility and energy absorption, it is very economical and affordable and it is used in constructing high buildings, retrofitting buildings and tanks. In this paper we have tried to examine the seismic behavior of steel and composite shear walls. For this purpose several models of steel shear and composite walls from one to five stories were constructed and analyzed by Abaqus software. The result show that composite steel plate shear walls has more ability to absorb energy, spread produced stress to different parts of the steel plate and ductile than steel shear walls. The curve hysteresis loop of composite steel palate shear walls is more stable and sustainable than steel shear wall. With increasing the number of stories, the initial strength and stiffness is decreased due to increase in lateral shift but the amount of absorbing energy and ductility is increased. The force tolerance in composite steel plate shear wall models is increased in comparison with steel shear walls.

**Keywords:** Steel Shear Wall, Composite Steel Plate Shear Walls, Absorbing Energy, Ductility, Stiffness.

## 1. Introduction

Iran seismicity and importance of enduring design of structures against lateral forces are vital for the country sustainable development. Selecting the type of resisting system against lateral forces depend on loading combination, structural behavior, directing gravity loads to the base and architectural design. In addition, the types of resisting structure against lateral loads also depend on structure size, regulation limitation, amount of lateral force and maximum displacement. Steel shear walls have been considered widely in the last three decades and is developing rapidly. This system is 50% cheaper than Bending frame. Steel shear wall looks like a steel cantilever beam which is used as a resisting system against lateral loads in moderate or high buildings. The total resistance resulted from diagonal tension field occurred in steel plate composite with bending operation [1].

Steel composite shear walls which are made of a thin steel plate covered with reinforced concrete on one or both sides is more resistant, plastic (shapeable) and absorbs

more energy; it is very affordable and can be used in buildings tall structures, reinforcing the structures and reservoirs.

The main purpose of concrete layer on steel plate is to prevent buckling out of steel plate so that the plate can reach its shear submission limits [2].

Composite shear wall is more capable in absorbing energy, separating tensions to different parts of steel plate and being plastic.

 \* Corresponding Author Email: Lshahryari@yahoo.com

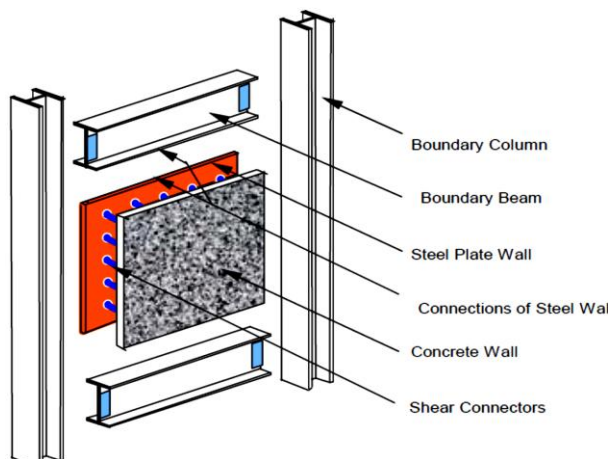

Figure 1. Main elements of a steel composite shear wall

System behavior in plastic environment and the amount of absorbed energy is better than other systems. Here due to being more integrated, particularly in comparison with mooring systems, tension distribution was more uniform which resulted in more compatible and proper behavior in plastic environment [2,3].

Both steel and composite shear walls have post buckling, but the difference is that steel shear wall has general buckling and only some parts' resistance will be used while buckling in composite shear walls is positional and therefore all resistance of steel plate will be used [2][3].

Here is some example which successfully used steel composite shear walls:

- A. San Francisco 18 story Hospital (1977)
- B. Nippon 20 story Official Building in Japan, Tokyo (1970)
- C. Shinjuku Nomura 53 story building, Tokyo (1978)
- D. Dallas 30 story Hotel, Texas (1988)
- E. Los Angeles 6 story Hospital, California (1970) [4], [5].

## 2. Previous Studies

Researchers from Alberta University, Canada, have carried out testes on Steel shear walls without stiffeners. Force-displacement hysteresis circles of the structural system showed its Plasticity behavior and significant increment of resistance. Thorburn (1983) proposed an equation based on his studies for traction curve angle which had consistency with current results [6].

Driver (1998) published the results of cyclic loading for a steel shear wall sample with 4 story. Even though the pillars damaged soon in the sample, but reciprocating behaviors of sample show an increase in plasticity and also resistance increment for 1.3 [7].

Takanashi (1973) carried the cyclic loading tests for 12 samples with 1 and 2 story. The samples were loaded

along diagonals so that a pure incision was created in the panels. The samples were highly shapeable and the angle of lateral displacement reaches to 0.1 degree. The results were totally in consistence with estimation made based on Mises-Von criteria [8].

Yamada (1996) published the results of cyclic loading test on composite and steel shear walls. Samples were loaded monotonically along the diagonal. Damage mode occurred due to boarder frame. Samples behaviors were totally plastic and pull field formed along the diagonals [9].

Nakashima et al (1994) published the behavioral results of panels of steel shear walls with low yield point under cyclic loading. Test on LPY steel under cyclic loading, showed stable hysteresis diagrams and relatively high energy absorption capacity [10].

Roberts and Sabouri Ghomi, UK, (1992) published the results of 16 tests carried out on steel panels under diagonal loading. They have presented the results of a nonlinear dynamic analysis on steel shear wall with steel thin plate. The results confirmed the answers of elastic analysis and also showed the effect of seismic factors in preventing intensification of cyclical dynamic loads [11].

Elgaaly et al, USA, (1993) concluded that when a steel plate without stiffener is used as a sheared wall, non-elastic behavior starts by wall flowing and the form of plastic hinge in columns determine system resistance [12]. Dr. Aastaneh et al, from Berkeley University (2001-2002) test two structures with 3 story under cyclic loads. The approximate elastic behavior of first sample to internal deformation was observed to 0.6%. The sample tolerated 19 cyclic loading and more than 3.3 % of max cutting before reaching the inner story relative displacement, while the non-elastic cycle is 39. Similar to the first sample, the second one also showed a proper shapeable behavior and performed elastically to 0.7% relative displacement. The sample tolerated up to 29 cycle shear force more than 1225Kips [5,6].

## 3. Modeling

In order to have a better comparison of Seismic Behavior of composite and normal steel shear walls, 10 models including 5 composite shear walls and 5 normal shear walls with similar size in different stories (1 to 5 story) and with span length and height of 2 meter for each story were stimulated and analyzed by Finite Element Method in 3D mode by Abaqus v.6.12 software.

In order to validate the modeling, a sample of Dr. Aastaneh Asl was stimulated in Finite Element Method. Material profile of used materials is listed below:

A-Steel Plate: Steel A36 with Yield Stress 36ksi (248Mpa) and Final tension 58ksi (400Mpa)

B-Beam and Pillar: A572 Grade 50 Steel with Yield Stress 50ksi (345Mpa) and Final stress 65Ksi (448Mpa)

C-Concrete: Compressive strength 4000 psi (27/58Mpa)  $f_c$

Force curve- Force displacement of sample is resulted from its Hysteresis curve push. Fitting these two curves shows the capability of selected model and Finite Element Method in estimating sample behavior.

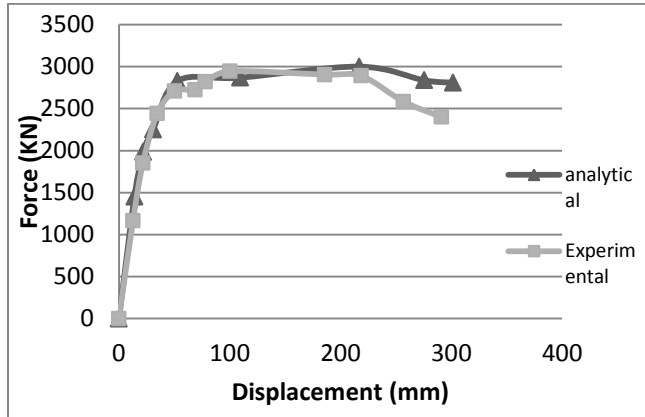

Figure 2. Comparison of load-displacement curve experimental of sample and analytical model

### 3.1. Models Profile:

Shell element was used in all models for beams, pillars, steel plates and concrete. Sections and profiles of materials used in the models are listed below:

Table 1: Sections and profiles of model elements

Row	Model elements	Section/ Thickness	Thickness/ Value
1	Pillar	IPB 200 ~ IPB 340	-
2	Beam	IPE 200 ~ IPE 300	-
3	Steel plate	-	5 mm
4	concrete	-	50 mm
5	Rebar	Ø 8 @ 100	∇ volume in each direction

Table 2. Steel Materials Profile

Row	Description	Density ( kg/m <sup>3</sup> )	Modulus of Elasticity ( Gpa )	Poisson Ratio	Yield Stress ( Mpa )	Final Stress ( Mpa )
1	Beam	7850	210	0.3	360	520
2	Pillar	7850	210	0.3	360	520
3	Steel plate	7850	210	0.3	240	370
4	Rebar	7850	210	0.3	350	500

Both elastic and plastic areas were considered to stimulate concrete behavior. Concrete Damage Plasticity model was used to stimulate concrete behavior in plastic area and to

investigate the damage. Profiles used for concrete behavior simulation are listed in below tables:

Table 3: Concretet Profile

Row	Material	Density ( kg/m <sup>3</sup> )	Modulus of Elasticity ( Gpa )	Poisson Ratio	Compressive Strength ( Mpa )	Tensile Strength ( Mpa )
1	Concrete	2400	25.1	0.2	28	2.8

Table 4: The parameters of the plastic concrete area

Viscosity Parameter	k	$f_{b0}/f_{c0}$	Eccentricity	Dilation Angle
0	0.67	1.16	0.1	30

Boundary condition and applying initial displacement of models described below:

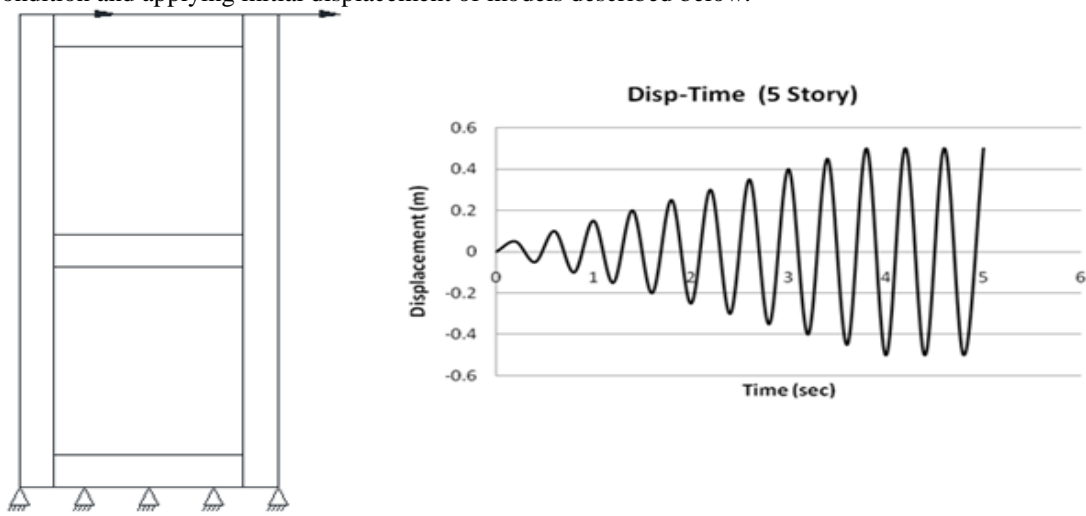

Figure 3. A) Displacement variation graph-time for a five floors model B) method of applying condition schematically

Table 5: Displacement applied to composite and steel shear walls

Stories	Displacement (cm)
First story	۱۰
Second story	۲۰
Third story	۳۰
Fourth story	۴۰
Fifth story	۵۰

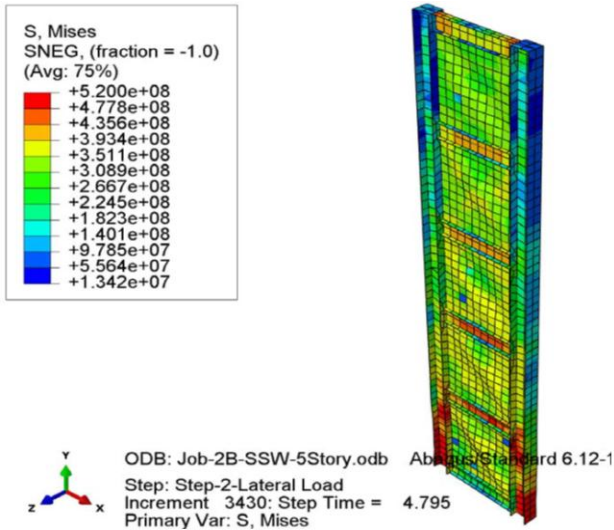

Figure 4: A modeled sample (Fifth story)

## 4. Modeling Results

### 4.1. Hysteresis curves of Samples:

Hysteresis curve of every structure shows the amount of energy absorption, stiffness, plasticity and etc. these

curves were showed below for normal and composite shear walls of 1 to 5 story.

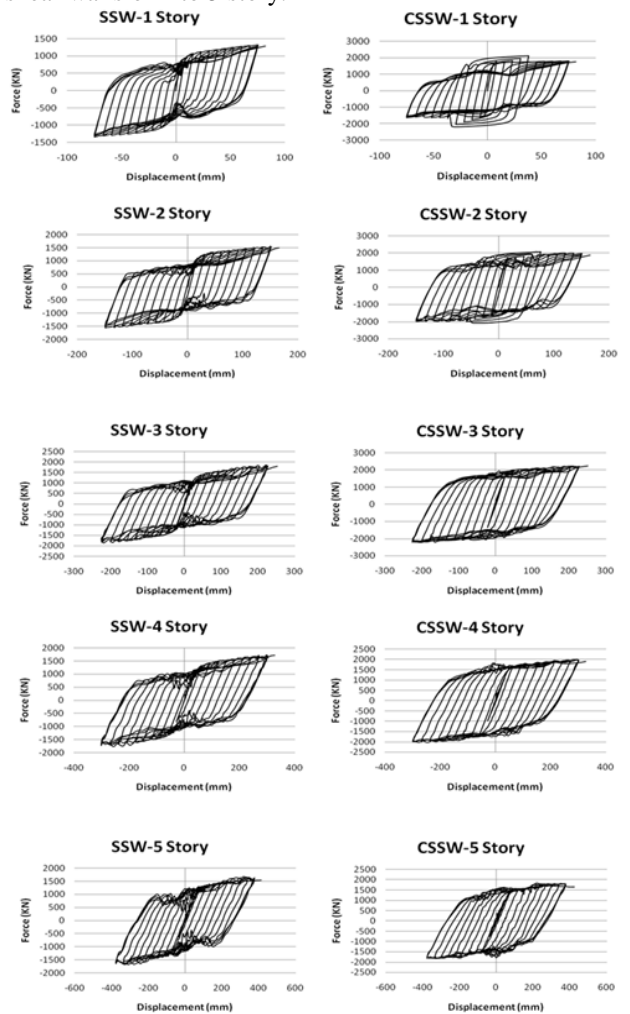

Figure 5. Hysteresis curves of steel and composite shear walls for 1 to 5 story

**4.2. The Amount of Energy Absorption**

The main performance of concrete cover is to prevent buckling out of steel plate. Due to increment and uniform distribution in diagonal lines of steel plate, the plate can have higher buckling modes and in other word the pas buckling phenomenon occurs. Therefore instead of a limited part of plate all of steel plate resistance shall be used and so Hysteresis circles would become more sustainable and well ordered.

Also buckling force which results in plate submission will be increase more in composite shear wall models.

The amount of energy absorbed by each sample which obtained by calculating the area below Hysteresis curves of each sample, was calculated by high accurate AutoCAD software. Below table and graphs compare the area of Hysteresis curves in sample which indicates the amount of absorbed energy and plasticity, also an increment in absorbing energy by composite shear walls was observed.

**Table 6.** Comparison of Hysteresis curves area in samples

Stories	Hysteresis curves area in samples		Increment %
	SSW)Normal(	CSSW)Composite(	
First story	17.3	31.1	80%
Second story	38.3	62.9	64%
Third story	64.8	93.1	44%
Fourth story	80	107.3	34%
Fifth Story	95.4	117.2	23%
Average			49%

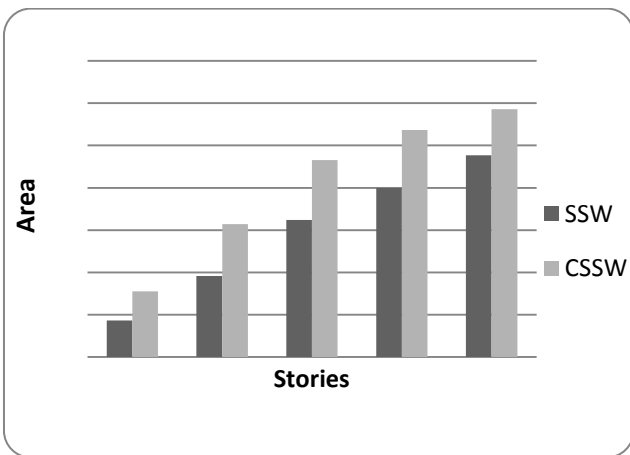

Figure6. Hysteresis curves area in samples

**4.3. Stiffness amount**

The amounts of displacement variation decrease in composite shear walls' model in comparison to normal shear walls. Therefore it can be concluded that converting steel shear wall to composite walls would decrease lateral

displacement or in the other hand would increase the stiffness. The reasons for the increment are diagonal stress field and post buckling in steel plates.

The amount of stiffness in each sample is obtained by calculating Hysteresis curve slope or by dividing force by displacement.

$$F = k\Delta \Rightarrow k = \frac{F}{\Delta}$$

$$\tan \theta = \frac{\sin \theta}{\cos \theta} = \frac{y}{x}$$

$$k = \tan \theta$$

F : Force( KN )  
 Δ : Displacem ( mm )  
 k : Stiffness ( KN/mm )

A comparison of initial stiffness and initial increment of stiffness between steel and composite shear walls is illustrated in below tables and graphs.

**Table 7.** Comparison of samples' initial stiffness

Stories	samples' initial stiffness		Increment %
	SSW)Normal(	CSSW)Composite(	
First story	161.02	294.52	83%
Second story	83.71	137.7	64%
Third story	50.69	74.43	47%
Fourth story	29.93	39.55	32%
Fifth Story	18.59	22.8	23%
Average			50%

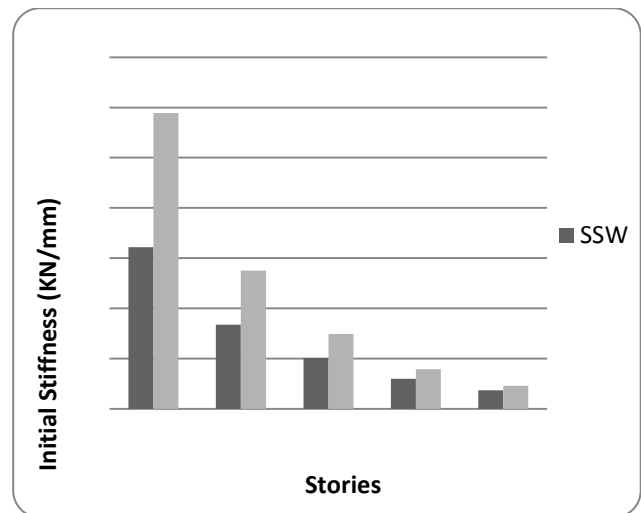

Figure 7. Samples' initial stiffness

**4.4. Maximum tolerated force by steel and composite shear walls:**

Maximum tolerated force by steel and composite shear walls resulted from same displacement is illustrated for similar models in below graphs and tables:

Table 8. Maximum tolerated force by samples

Stories	Maximum Tolerated Force		Increment %
	SSW)Normal(	CSSW)Composite(	
First story	1365.43	2112.98	55%
Second story	1620.18	2069.11	28%
Third story	1860.92	2248.62	21%
Fourth story	1733.22	1996.06	15%
Fifth Story	1675.91	1847.97	10%
Average			26%

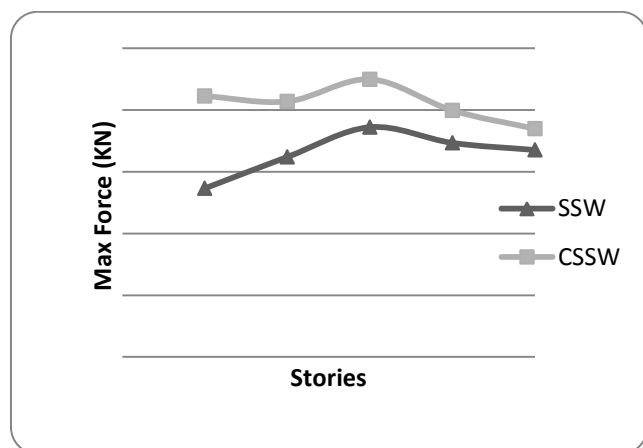

Figure 8. Maximum tolerated force by the samples

## 5- Conclusion

1. Composite shear wall was more capable in energy absorption, spreading stress to different points on steel plate and being plasticity than shear wall.
2. Adding concrete cover would increase the stiffness of composite shear wall and decrease lateral displacement.
3. Hysteresis curve circles of composite shear wall were more sustainable and well ordered.
4. As the number of stories increase, resistance and initial stiffness decrease due to lateral displacement but the amount of energy absorbing and plasticity increase.

5. In comparing with steel share walls, the amount of tolerated force was increased composite share wall

## References

- [1] Gholhaki, M. and Sabouri, S. (1388) The effects of ductility coefficient on steel shear walls behavior with thin plate Coefficient. Scientific and Research steel and structure 5 (5).
- [2] Hatami, F. and Sahri,S.M. (1387) studying of changes in the thickness of steel plate on composite shear wall. Scientific and Research steel and structure 4(4).
- [3] Armaghani A. and Naloosi,J. (1389). Stiffness and ductility of composite shear wall with concrete layer in difference with steel shear wall. Iran Second national concrete conference, Tehran, Iran
- [4] Astaneh-Asl, A. (2002) Seismic Behavior and Design of Composite Steel Plate Shear Walls. *Steel Tips reports*, Department of Civil & Environmental Engineering, University of California, Berkeley.
- [5] Astaneh-Asl, A. (2001) Seismic Behavior and Design of Steel Plate Shear Walls. *Steel Tips reports*, Department of Civil & Environmental Engineering, University of California, Berkeley.
- [6] Thorburn, L.J., Kulak G.L., and Montgomery C.J. (1983) Analysis of steel plate shear walls. Structural Engineering report No. 107, University of Alberta, Canada.
- [7] Driver, R.G., Kulak, G.L., Kennedy, DJL., and Elwi, AE. (1998) Cyclic test of four-story steel plate shear wall. *J Struct Eng ASCE*, 124(2), 112-120.
- [8] Takanashi, Y., Takemoto, T., and Tagaki, M. (1973) Experimental Study on Thin Steel Shear Walls and Particular Bracing under Alternative Horizontal Load. *Preliminary Report*, Lisbon, Portugal.
- [9] Sugii, K., and Yamada, M. (1996) Steel Panel Shear Walls with and Without Concrete Covering. *11th World Conference on Earthquake Engineering*, Acapulco, Mexico.
- [10] Nakashima, M., Iwai, S., Iwata M., Takeuchi T., Konomi S., Akazawa T. (1994) Energy Dissipation Behavior of Shear Panels Made of Low Yield Steel. *Earthquake Engineering and Structural Dynamics*, 23, 1299-1313.
- [11] Sabouri-Ghomi, S., and Roberts, TM. (1992) Nonlinear dynamic analysis of steel plate shear walls including shear and bending deformations. *Engineering Structures 1992*, 14(5), 309-317.
- [12] Elgaaly, M. , Caccese, V. (1993) Post-buckling Behavior of Steel- Plate Shear Walls under Cyclic Loads. *J. of Str. Engrg. ASCE*, 119(2), 588-605.