

Analysis of the Earth Dams Function against the Effects of Long-Term Deposition in Reservoirs (Polrood Earth Dam- Guilan Province)

Mahdi keshavarz^a, Nasser Shamskia^{*,b}

^a*Department of civil engineering, Qazvin Branch, Islamic Azad University, Qazvin, Iran.*

^b*Department of civil engineering, Qazvin Branch, Islamic Azad University, Qazvin, Iran.*

Received 18 May 2018, Accepted 30 August 2018

Abstract

Estimation of sediment transport load due to erosion in river basins is one of the main issues which is essential for many projects related to water resources, soil and dams construction. In regards to the phenomenon of erosion and transmission sedimentation in rivers has always led to deformation in the seaboard and sedimentation. Therefore, the management and planning in bank of rivers is important in water and soil resources and damp construction. Hence, checking the flow capacity of the sediment transportation and the sediment transportation mechanism in the river hydraulics and their sedimentation in dams are always one of the most fundamental problems in dams construction, and consumable life of dams are also directly related to this phenomenon. To deals with this issue, in this research, after predicting the 57-year-old sediment, the effects of sediment on Polrood earth-filled dam has been investigated using FLAC3D software. The results show that the effective stress and displacement in the upstream shell are approximately equal to the state without applying sediment pressure.

Keywords: *Sediment load, earth-filled Polrood dam, Sediment forecasting, FLAC3D software*

1. Introduction

Earth-fill dams are one of the most important and biggest hydraulic structures, which their technical and economic considerations are very influential. Also, due to the technology of the day it is necessary to model the dam with valid software and to check the results. The known parameters of materials used in the dam should be modified and appropriate boundary conditions. The numerical modeling parameters will be improved using the rules the knowledge of dam construction [1]. The major part of the deformation and possible damages of the dam during the construction of dam and the first dewatering should be studied to investigate the behavior of earth-fill dams through the stages of construction. The major part of the pore water pressure in the core of dam is created at the time of construction, which this issue reveals the need for numerical modeling and behavioral testing during construction [2]. The pore water

pressure level, completely influenced by the construction speed, and when the rate of the layers construction is high, the created pore pressure will be suddenly increased. If the construction speed of the clay layers is high, the pore pressure water will be raised due to the impossibility of drainage. Therefore, critical condition and the occurrence of a dam breaking phenomenon are likely to be happened [3, 4]. The cause of serious problems during its implementation and exploitation can be prevented by analyzing and predicting the behavior of dams in the construction and exploitation stages [5].

Darsanj (2009) investigated the behavior of the Alavian dam during the construction stages and the first dewatering using numerical analysis and Back-up analysis. They used the FLAC2D software to model the dam to check the horizontal displacements, total stresses, dewatering processes, and changes in arc ratio of dam at the end of construction [6]. Pang (2000) investigated the

 *Corresponding Author Email address: shams@qiau.ac.ir

effect of the pore water pressure on the strain stress behavior of earth-fill dams and provided the results of stress strain behavior at different times. They evaluated the pore water pressure and the ratio of settlement during the construction of dam using the computer codes. Eventually, they found the ultimate stress-strain behavior of the bottom layer in dam [7].

Wang et al. (2013) examined the hydraulic fracture phenomenon using a finite element model. They used homogeneous and non-homogeneous material for dam to investigate the effect of the pore water pressure on the formation. Accordingly, they evaluated the occurrence of the hydraulic fracture phenomenon. Their results showed that pore water pressure has a significant effect on the mentioned phenomenon [8].

Daghigh H. et al. (2015) analyzed the stability of earth-fill dams in relation to time, using the finite element software, PLAXIS. To do so, they utilized four numerical models based on different layers of foundation and dam body, with consideration of the homogeneous and non-homogeneous earth-fill dam properties. In addition, the coarse-grained and fine-grained have been simulated. By analyzing the results of model, it was observed that in order to prevent the destruction of homogeneous and non-homogeneous earth-fill dams from under foundation, the dam should be consolidated step-by-step and appropriate consolidation time should be considered in order to excess pore water pressure be dissipated. Otherwise the high pore water pressure can cause the dam to be damaged from under the foundation. Also, during weak foundations, they found that the performance of homogeneous dams is better than non-homogeneous dams [9].

Honarmand et al. (2015) compared the results of three and two-dimensional analysis of earth-fill dams located in Tang valleys (case study of the Vaniyar dam). The results showed that the settlement formed in the upper half of the dam height in terms of two and three-dimensional analysis is consistent with a small margin of error. However, in the lower half of the height of dam, the difference between the results is high. Hence, that the two-dimensional analysis shows greater values than the three-dimensional analysis and instrumentation. Although, in the total vertical stress section and pore water pressure in foundation, the most part of study section of a two-

dimensional analysis has higher values than the 3D analysis [10].

Feng et al. (2010) investigated the numerical earthquake response analysis of the Liyutan earth dam in Taiwan. They proposed a method combining LEM with numerical analysis to evaluate the stability of geomembrane surface barrier of earth dam. The formula of calculating the factor of safety for geomembrane barrier systems taking account of the effect of interface strain softening was derived. An example of composite geomembrane lined earth dam was numerically analyzed to verify the developed method. The calculated factor of safety is between the results that calculated from LEM using peak shear strength and residual shear strength. Through comparatively analysis with LEM results, it is suggested to use peak shear strengths along the basal interface and residual shear strength along the side slope interface in evaluating stability of geomembrane surface barrier of earth dam using LEM [11].

Broojerdi et al. (2018) analyzed the dynamic behavior of rock slopes using the distinct element method based on a case study at the right abutment of the upper Gotvand Dam, Iran. The right abutment comprises a soft clayey layer called the Lower Mudstone Siltstone interlayer (LMST) covered by disturbed conglomerate blocks. According to the results of the dynamic numerical analyses, no collapse will occur at the right abutment area. However, the residual shear displacement of disturbed blocks on the LMST layer will be 20–60 cm for Maximum Credible Earthquake (MCE) loading. Such a displacement can cause cracking in the cut-off wall, and hence it was considered the main indicator of the right abutment instability. Investigating the different solutions including a buttressing and excavation showed that these approaches are not effectively preventing abutment shear displacement. Therefore, the designing process was carried out by accepting the risk of cut-off wall cracking in seismic loading conditions. However, some pre-remedial solutions (as discussed thoroughly in the text) have been considered in the construction process to minimize the risk of water seepage from the cut-off wall [12].

Russo and Dello (2017) attempted to investigate the near-source effects on the ground motion occurred at the Conza Dam site (Italy) during the

1980 Irpinia earthquake. The paper illustrated that the procedure developed to define the input motion at the Conza Dam site (Italy) during the 1980 Irpinia earthquake (November 23, 1980; Mw = 6.9). Due to the short distance of the site from the fault area, the Conza Dam is representative of several large dams placed in near-source areas in Italy and worldwide. The paper focused on two issues including: (1) the reconstruction of the regional structure of the Campania–Lucania region on the basis of former literature studies and on a new calibration of the 1D velocity model at regional scale; (2) the definition of the reference input motion at the site of Conza Dam with highlights on the spatial variability of the ground motion below the dam foundation and related effects on the structure [13].

2. Specifications of Polrood Dam in Guilan Province

Polrood reservoir dam is an earth-fill dam with clay core and is located in northern region of Iran in slopes of the Alborz mountains and in the range between 36-30 and 15-37 degrees the northern and longitudinal 49-45 to 50-45 eastern degree. This dam belongs to Guilan province. The basin of river is mainly mountainous and its maximum height is 3800 m, its average height is about 1928 m and its

area until construction site of the dam is about 1634 square kilometers. The studied area is close to the Caspian Sea from the north, and from the south is close to the Alborz high mountain. In Table 1, a summary of the technical specifications of the Polrood dam is provided.

Table 1. General Specifications for Polrood Dam

Earth with (GC) core	Dam type
209.38(m) from the sea level	Maximum balance
203(m) from the sea level	Normal alignment
210(m) from the sea level	Crown Layer
172(m) from the sea level	Minimum level of operation
572(m)	Crown length
12(m)	Crown width
110(m) from the sea level	The river bed leveling in the axis

In Figure 1, the cross section of the Polrood dam is presented. The core of dam is protected by two filter layers in upstream and downstream. The upstream crust with a gradient of 1: 2.2 and a downstream crust are designed as a step from a gradient of 1: 20 to a gradient of 1: 1.8.

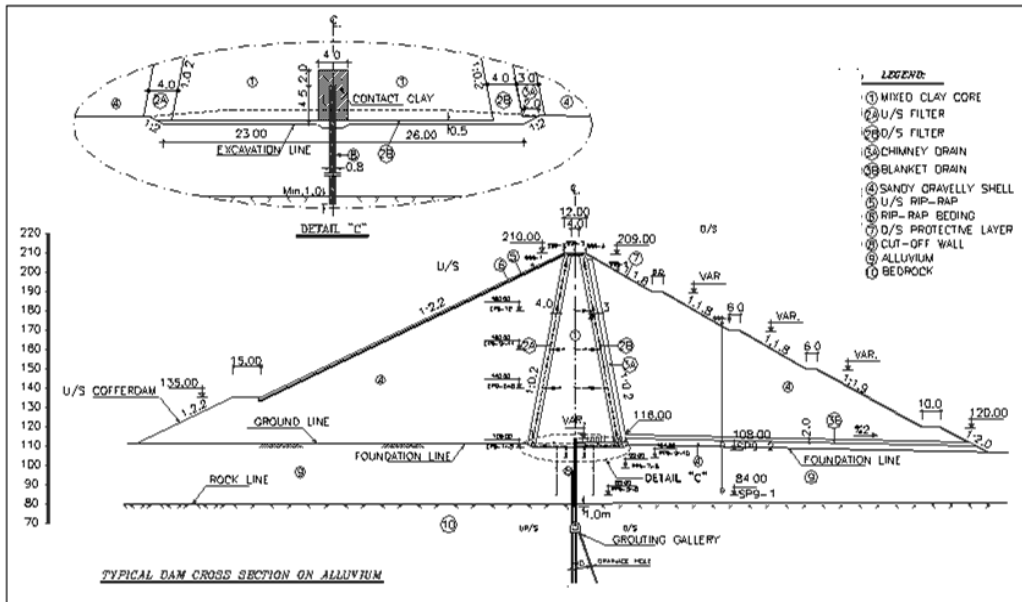

Figure 1. Cross section of Polrood Dam in Guilan Province

3. Numerical modeling

FLAC3D software has been used for 3D modeling of the Polrood dam. This software is based on Finite difference method. Due to the fact that the analysis for construction is accompanied by the stable seepage, the boundaries are double times of the height of the dam from the lower and upper part and the depth of the foundation is considered as the height of the dam. Also in order to ease the analysis and determination of the effects of sediment load on the cross section of earth-fill dam of Polrood, the width of cross section of dam is considered 100 m. Fig 2.

The parameters of the behavioral model of hardening and softening strain used in numerical analysis are presented in Table 2. In this table is ρ mass density, G shear modulus, K volume module, C cohesion, (ϕ) maximum internal friction angle at the moment of rupture and k is the mobility coefficient of water in the soil.

The perimeter boundaries of the model are fixed against the lateral displacement and the bottom of model is fixed against lateral and vertical

displacement. For modeling, firstly, all parts bodies of the dam are removed from the model and in order to create the initial stresses, the dam is simulated alone. The modeling is then simulated in a 25-layer process in the software. Figure 3.

After determining the area, the volume and the occupied depth of sediment in the reservoir of the Polrood Dam is produced (Keshavarz and Shamskia 1396) [14]. The height of the sediment in the reservoir of the dam is equal to 50 meters and the sediment volume is 57 years' old which is equal to 114151579 ton/y/km².

Also, for better determination of the effects of sediment on the earth-fill dam, the level of displacement is zero, and with applying stress in nine stages, which is equivalent every five years, this value was applied to the earth-fill dam, so that by increasing the height of dam, the amount of sediment load will be reduced, and is added to the lower value. In such a way that at height of 12 meters, the sediment loads is 272.7690 Pa. But this rate at height of 44 meters is about 192.7690 Pascal. Table (3).

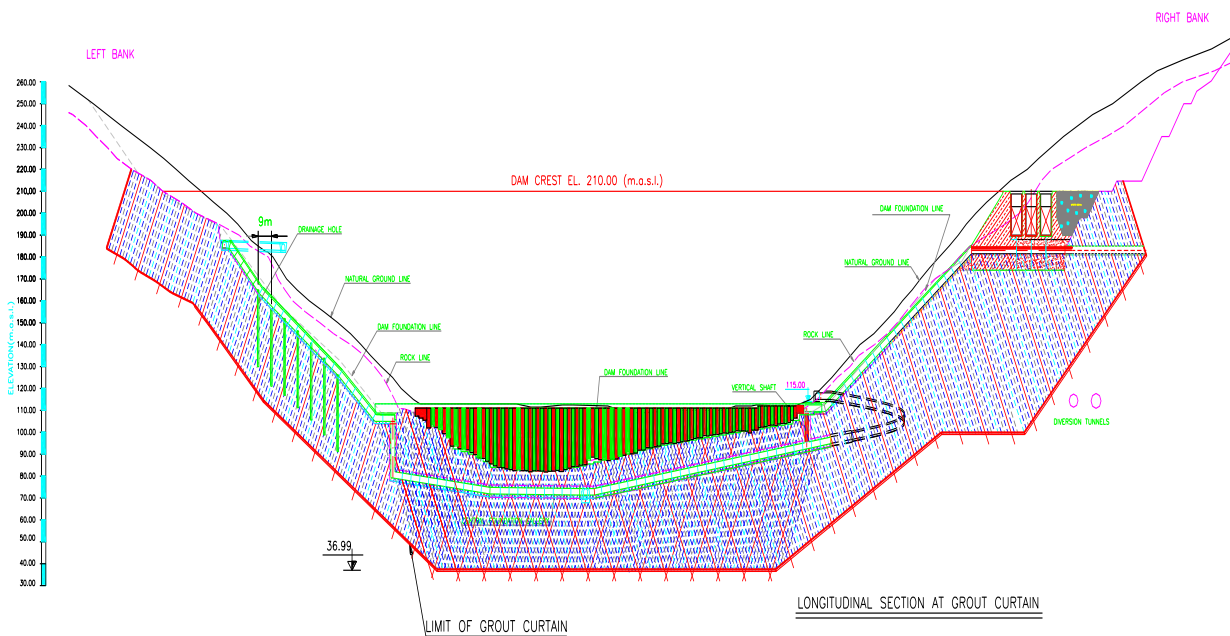

Figure 2. Cross section of the plain river valley in Guilan province

Table 2. Parameters of the behavioral model body materials, Alluvial foundation and stone foundation Polrood dam

Body materials and foundation	ρ (Kg/m ³)	G (Pa)	K (Pa)	C (kPa)	k (m ² /pa – sec)	ϕ (deg)
The shell	2300.0	1.430E7	1.906E7	0	1e – 10	38
Core	2100.0	4.903E6	6.537E6	50000.0	1e – 13	26
Alluvial foundation 28m	2200.0	2.138E7	5.576E7	0	1e – 10	36
Stone foundation to a depth of 40 m	2600.0	9.585E8	2.499E9	--	6.6e – 11	--

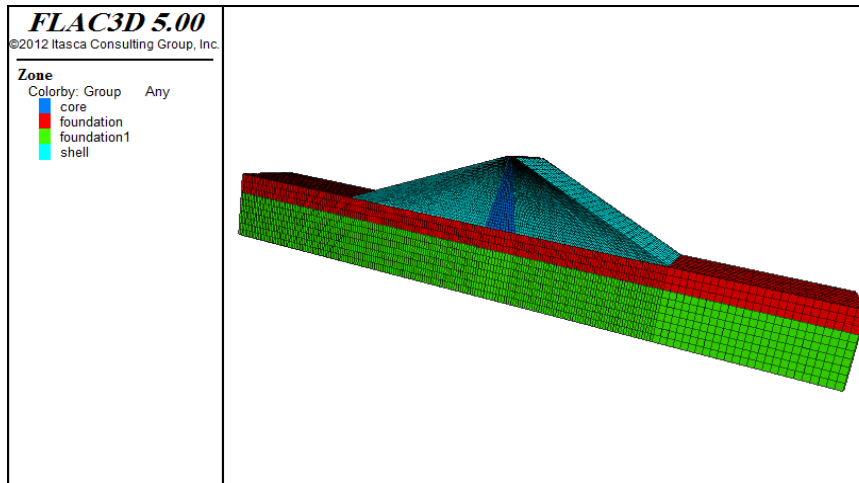

Figure 3. Designing the Polrood Dam Damage in FLAC3D Software

Table 3. Stages of sediment loading on the earth's dam

Height (m)	Sediment load (Pa)
12	272.7690
16	262.7690
20	252.7690
24	242.790
28	232.7690
32	222.7690
36	212.7690
40	202.7690
44	192.7690

4. Result Discussion

This section examines the results of the FLAC3D software.

4.1. Vertical Deformation

Settlement of gravel and sandy foundation is usually done throughout the building. The amount of this settlement is from a few centimeters to several meters which depend on the relative density of the soil, type of soil distribution and the size of the dam. Here, despite the Alluvium foundation, it's 28m of settlement is considered about 40 cm. And because the rest of the foundation is made of stone, the amount of settlement is zero. Normal conditions for dam settlement due to the settlement of the dam body is about 2% of the height of dam and in earthquake points of view this height is increased by 1% due to earthquake, but determining the total settlement for crown of the dam is not possible, because it depends on the type of soil and load of the dam (its height) [15]. Here, this amount settlement has been observed at the end of the construction of 2 meters and in the range of up to 26.2 meters, which is equal to 2% of the height of the dam Figure (4a).

In Figure (4b), the rate of settlement in z-direction in the stable level of seepage and at end point of the earth-fill dam is presented. As the above explanation, determination a rate for settlement is impossible, because it depends on the type of soil, the type of foundation and load of the dam (its height). At this stage, the settlement of dam is 3.48 meters, which engineers of the dam designer predicted this amount and according to this, they designed the dam. Another point which can be mentioned at stable seepage is a high amount of settlement above the water level in upper part, which is shown as an uplift or swelling here. This deformation is due to the fact that the crust is dry and dewatering is done. The effective stress inside the crust is decreasing, which is same as unloading in the soil, and swelling occurs. In reality after the dewatering and saturation of the soil collapse occurs. In a paper that was presented in 1986 by Duncan Nubry, he has presented a way which prevents the swelling in the software.

In Figure (4c), the displacement of earth-fill dam in z-direction is specified at the stage of sediment loading. As shown in Fig, as the height increases

and the length decreases, the amount of settlement increases, so that after 57 years, the up stream's crust settlement is about 1.67 meters.

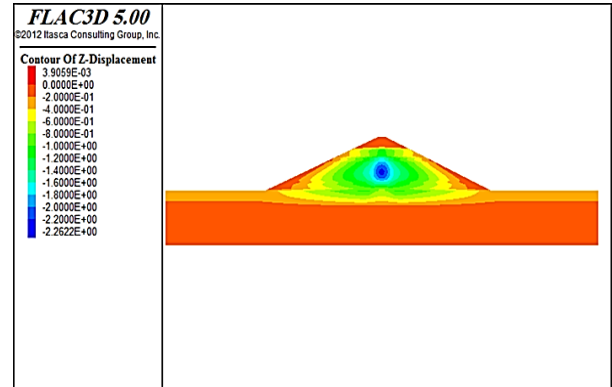

A. Z-Displacement in the final stage of construction

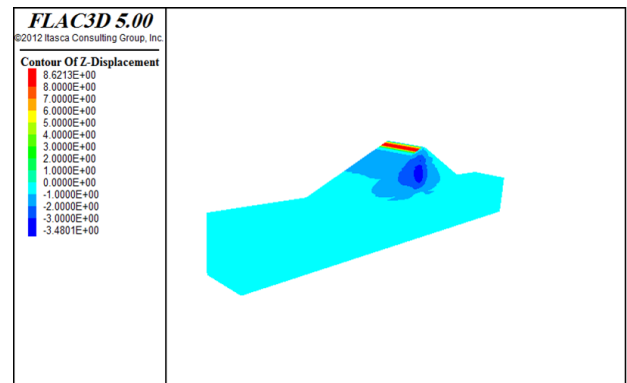

B. Z-Displacement in the permeation stage

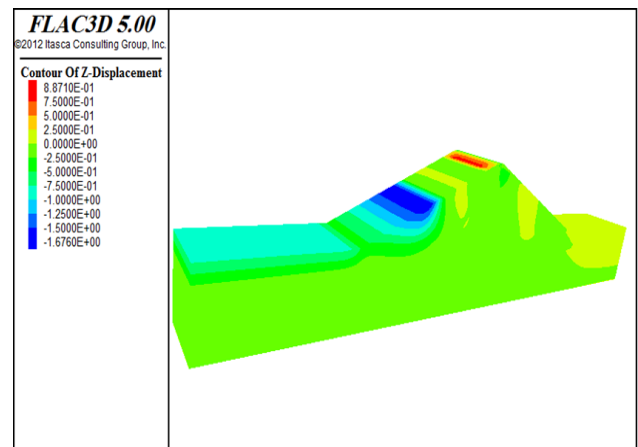

C. Z-Displacement after applying sediment load

Figure 4. Equilibrium curves of Z-Displacement in different stages of construction of Polrood Dam

4.2. Total Effective Stresses

One of the reasons for doing numerical analysis is to find the true values of total stress. Because the

results obtained from the pressure cells in the body of dam due to its implementation may not be accurate. Considering the core materials of earth-fill dams play a role of water stop and shells play the role of the stability of the dam, the difference in the hardness of the crust and core materials leads the difference in the modulus of elasticity which in practice tends to result in non-uniform deformations, especially in the boundary region of the shell and crust. As shown in Figure (5a) at the end of construction, the stress in the adjacent core is less than the stress in the shell, because the core tends to move and the shell prevents movement, and a shear force is created between two boundaries, which It takes part of force from core and transmits this force to the shell, which has been described as arctic phenomenon, that leads to low stress inside the core and excess stress on the shell.

At stage of seepage, the stress dropped from $3.82e6$ to $3.46e6$ psi, the more range of the earth-fill dam is taken Figure (5b). In Figure (5c), the amount of effective stress after sediment loading is determined. The amount of effective stress after 57 years in the upstream crust pattern has a slight difference up to the height 50 meters with a steady flow pattern. However, the $3.17e6$ Pascal covers upstream foundation.

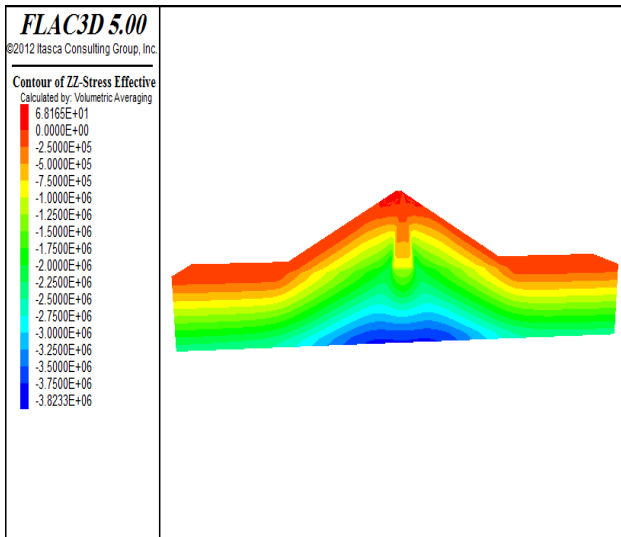

A. Effective tension at the end of construction

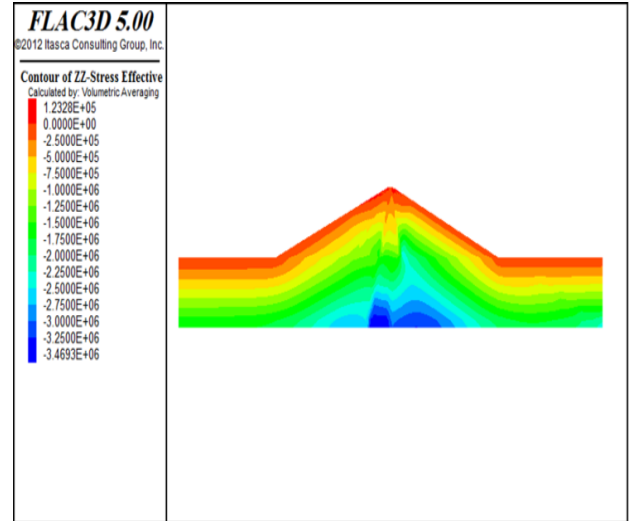

B-Effective stress in the permeation stage

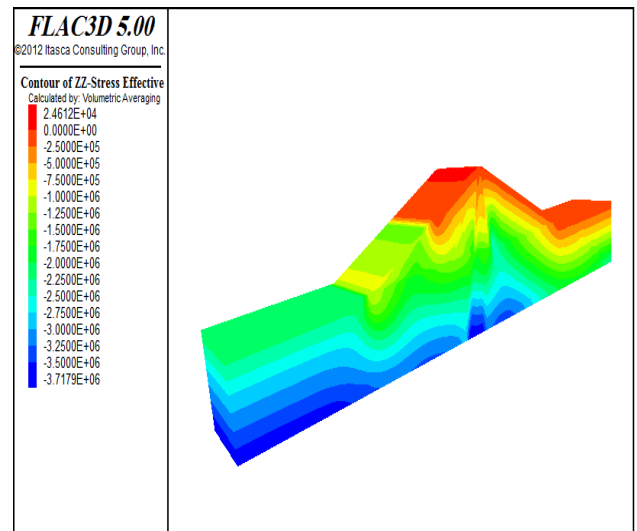

C-Effective stress after applying sediment load

Figure 5. Equilibrium curves of Effective stress in different stages of construction of Polrood Dam

4.3. Pore Water Pressure

As shown in Figure (6a), at the end of construction, the water level in the core is approximately equal to the groundwater level and the pore water pressure in the areas above the surface of the water is dissipated in the core of dam.

Figure (6b) illustrates the flow network in the stable stage of seepage, the free drained line (or phreatic level) surface is a surface which is below this level, the pressure of the water is positive, and above this surface, is a capillarity zone with a negative pore pressure. The state of this level which shows the highest flow network is not depend on the permeability of the environment,

according to (Cassagard), even the permeability or non-permeability of the foundation doesn't have any effect on the condition of the free drained path (the level of or phreatic). [12] At the stage after the sediment loading, the amount of pore water pressure has a slightly changing to stable seepage. Figure (-6c)

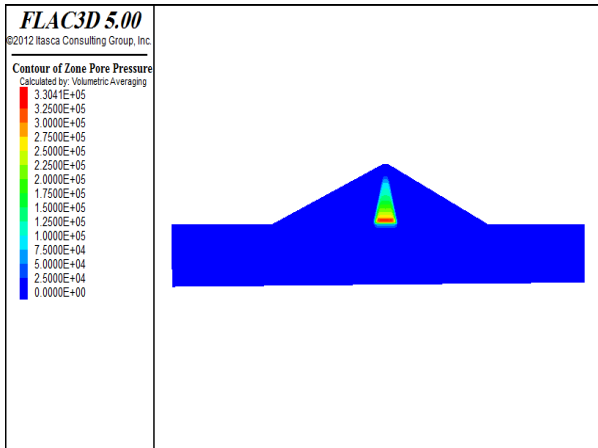

A. Pore pressure cavity at the end of construction

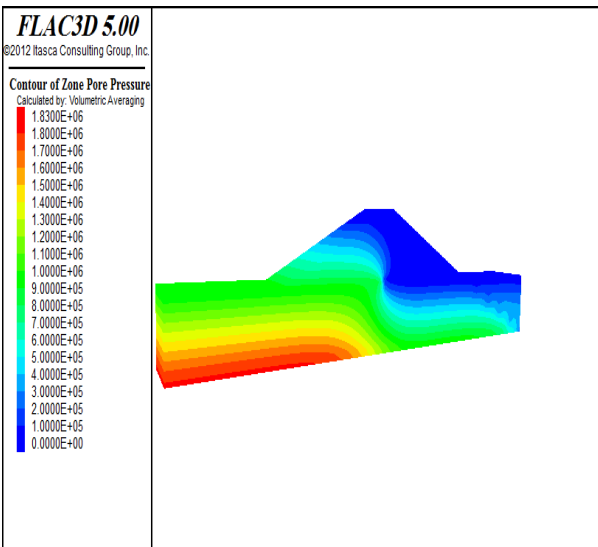

B. Pore pressure cavity at the end of permeation stage

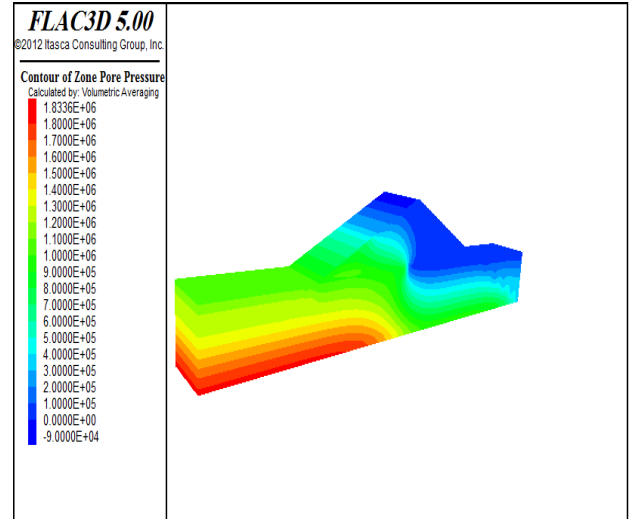

C. Pore pressure cavity at the end of after applying sediment load

Figure 6. Equilibrium curves of Pore pressure in different stages of construction of Polrood Dam.

As seen in Fig. 7, history from the body of the earth-fill dam from the upper crust up to the crest of dam is different at z and x, and is constant in y which the center of the dam has been fixed. The results show that, the highest amount of settlement in z direction between the height of 36 and 48 meters is about 1.67 meters line1. From the figure it can be concluded as move toward to the crown and crest this value decreases and it gets to zero

As shown in figure (8), history from the body of the earth-fill dam from the upper crust up to the crest of dam is different at z and x direction, and for y the center of the dam body which is constant has been taken. The maximum amount of settlement in upper shell along x in the height between 28 and 40 meters is 94 centimeters with line1, which it leads towards the crown and foundation this value decreases and it gets to zero.

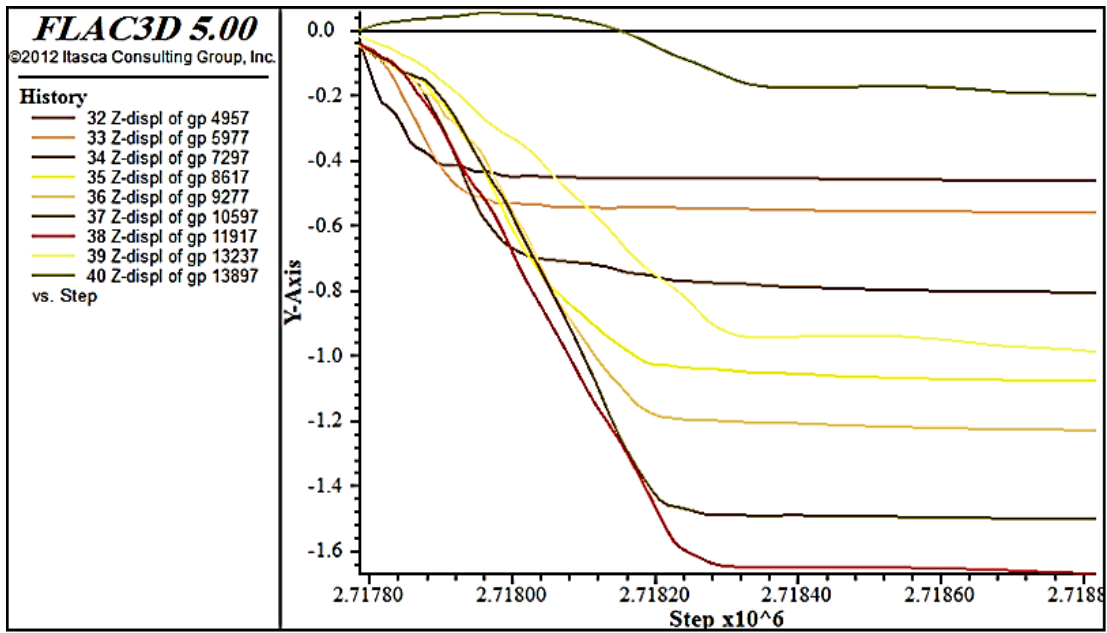

Figure 7. History along z in the body of the earth's dam at the stage of sediment loading

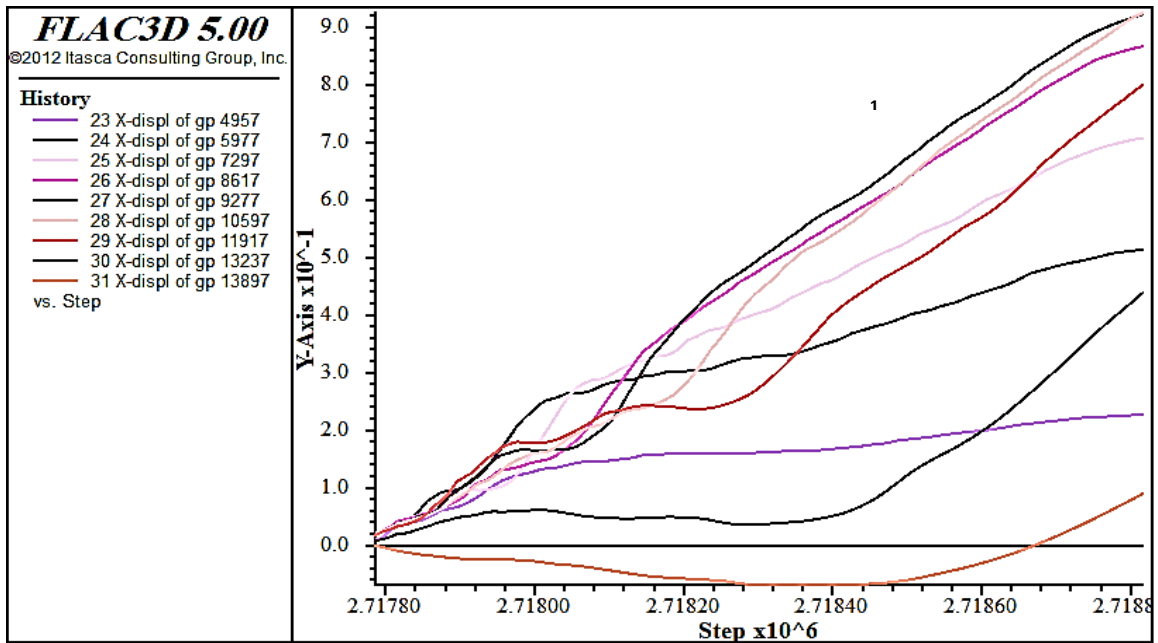

Figure 8. History along x in the body of the earth's dam at the stage of sediment loading

5. Conclusions

The results clearly show that the highest amount of vertical deformations occurred at the stage after the application of the sediment load between the height of 36 and 48 meters to 1.67 meters, and as far as it goes toward the crown and foundation, this value is reduced to zero.

One point that can be mentioned here is that the effective stress after sediment loading which the highest density to take place in the range of 1e6 to 1.6e6 Pa, and is observed at an altitude between 0 and 50 m upstream of the upper crust in the range of sediment load. Also, the highest value of effective stress occurred in the initial portion of the

upper crust at the 239-meter axis. Another noteworthy point is that effective tidal variations before and after sedimentation are noticed, which is negligible after 57 years.

6. Reference

- [1] Bagherzadeh Khalkhali, B., "Common Instrumentation in Soil- Grit Dams", Workshop of Moshanir Power Engineering Services Co, Tehran. 1-8 Nov, 2009.
- [2] Fatullah Marani, T., "Numerical Analysis of the Effect of Upstream Drainage on Cavity Water Pressure and Upper Sill Suspension of the Dam Dam under Rapid Evacuation of the Reservoir", Khajeh Nasir Al-Din Toosi University, for Ms.c of civil engineering. 200 pages, 2001.
- [3] Rahimi, H., "Soil Dams", Tehran Publication and Printing Institute, Third Edition. 671 pages, 2010.
- [4] Makrom, N., "Dynamic Analysis of Soil Dams with Asphalt Concrete Core", Master's Theses University of Tehran. 210 pages, 2002.
- [5] Ghorravi, M. and Mohammadi, M., "Investigating the Necessity of Layer Modeling in Static Analysis of earth Dam", 2nd National Conference on Damping. Islamic Azad University, Zanzan Branch, Jan. 10, Zanzan, 2009.
- [6] Darsanch, S., "Analysis and evaluation of the behavior of soil dams in Hussein's first dewatering-case study of Alavian Dam", Master's dissertation, Tabriz University. 215 pages, 2009.
- [7] Ng, C. W. and Pang, Y. W., "Influence of stress state on soil- water characteristics and slope stability", Journal of geotechnical and geoenvironmental engineering. 126 (2):157-166, 2000.
- [8] Wang, S.Y. and Sloan, S.W. and Fityus, S.G. and Griffiths, D.V. and Tang, C.A., "Numerical modeling of pore pressure influence on feature on fracture evolution in brittle heterogeneous rocks", Rock mechanics and rock engineering. 45(5):1165-1182, 2013.
- [9] Daghigh, H. and Darwish, H. and Mousavi, S. A., "Analysis of Susceptibility of Soil Dams to Time", Journal of Water and Soil Conservation. Year 5, No, 2, 2015.
- [10] Honarmand, M. and Brilliance, M. and Sadeghpour, A. H., "Comparison of 3D and Two Dimensional Analysis for Soil Dams Located in Tang Valley", Sharif Civil Engineering, Volume. 2-31, Issue, 2/1, 3-11, 2015.
- [11] Feng, Z. and Tsai, N., "Numerical earthquake response analysis of the Liyutan earth dam in Taiwan", Natural Hazards and Earth System Sciences. 10.6, 1269-1280, 2010.
- [12] Broojerdi, B. and Sharifi, M. and Behnia, M. and Hazrati Aghchai, M., "Dynamic analysis of rock slopes using the distinct element method: A case study at the right abutment of the Upper Gotvand Dam, Iran", Journal of African Earth Sciences. 145, 53-67, 2018.
- [13] Russo, Z. and Dello, A., "Near-source effects on the ground motion occurred at the Conza Dam site (Italy) during the 1980 Irpinia earthquake", Bulletin of Earthquake Engineering. 15,10, 4009-4037, 2017.
- [14] Keshavarz, M. and Shamskia, N., "Comparison of Estimation of Sediment Load Suspended by Two Methods Sediment Scale Curve and Artificial Neural Network (Case Study of Polrood River in Guilan Province)", 5th Annual International Congress of Civil, Architecture and Urban Development, Shahid Beheshti University, Tehran, Iran, December. 5-5, 2017.
- [15] Waffan, M., "Soil Dams", Isfahan: University Jihad, Isfahan Industrial Complex, Five Books. 512 pages, 2009.