

# Controller Design for Controlling the Inverter Grid in Island Mode

Mehran Ansarin, Maryam Torabi

Department of Electrical Engineering, Tabriz Branch, Islamic Azad University, Tabriz , Iran

Email: Ansarin.mehran@gmail.com , Maryam\_torabi70@yahoo.com

## Abstract

*In island mode, when the grid is separated from the rest of the system, the dispersed generation system acts to provide a constant voltage to the local load in the voltage control mode. In this paper .Sliding mode controls method based on the second-order sliding surface and to improve sliding mode control and increase robustness .The system is controlled by an adaptive control against disturbances. In this regard, to overcome chattering and uncertainty from the derivative of the control signal as a controller, which ultimately results in a control signal with integration, up to Adaptive sliding mode controller in the presence of unwanted and uncertain interference and interconnection of grid stability and improvement. Guaranteed output and tracking of the system as well as reducing unnecessary high frequency oscillations in the entire system slowly. According to the simulation results, it is seen that the inverter output waveform has a good ability to follow the waveforms of the voltage and referred three-phase current. This paper is simulated by MATLAB software.*

Keywords: micro grid, island mode, inverter, SVC control

## 1. Introduction

In recent years, power systems are experiencing tremendous growth in the field of distributed generation due to economic benefits, environmental concerns, reliability requirements, etc., mainly distributed scattering systems including wind turbines, photovoltaic cells, Small turbines and fuel cells. The use of distributed generation generators causes a lot of technical problems, increase in the short-circuit surface, the weakening of the coordination of the protection relay operation, harmonic production and transient states, micro grid islanding, voltage oscillations, and control problems are the most important ones (Gautam et al,2014). The concept of a grid is referred to networks with a low voltage, low

power and complex control structure. Another important issue, which is a fundamental indicator in determining the reliability of the control method used in the micro-grid, is the discussion of the voltage stability and the frequency of the grid in Island mode after an unusual event, which leads to voltage and the frequency oscillation of the grid. The severity degree to perturbation for making the grid unstability is a measure for effectiveness of the control method. This paper examines the grid control in island mode. In most paper in which scatterd distribution is discussed in recent years, little attention is paid to the design part of the controller to control the micro-grid inverter, and most of the controllers used to control the micro structure inverters are of the PID type and by

fuzzy controller feedback state. The sliding surface were adjusted for convenient of the coefficients, which tracking a reference signal has error of stabilized mode.(Aghatehrani and Vijayan,2013). Esmaeli(2016), the stability control of a micro-grid analysis and by the sliding mode control is checked in this paper. Also, in ZhiyongChen (2015) the adaptive sliding mode control has been used. In this paper, uncertainties, parameters variety and some types of disturbances in design are not considered.

In this paper, second-order sliding mode control is used to control the voltage of the three-phase inverter, which includes errors and trace error variations. Comparative control has been used in order to improve the sliding mode control and increase in system's robustness against disturbances and uncertainties of the model that estimates the degree of instability boundary to compensate the sliding mode Control method. With the help of the Lyapunov stability index, the stability of the system is also analyzed. In this paper, in control of the system, a second-order sliding mode control is used, which means that the inverter system equations with an additional derivative in the derivation appear in the sliding surface and to calculate the signal control from the sliding surface, derivative is calculated instead of the control signal The, and ultimately, the final control signal is generated by integrating with pulse width modulation. Advantage of this method is in reducing control system's oscillations and improving the control signal and eliminating chattering of sliding mode control ultimately

improve system output and tracking and reduction in unnecessary high frequency oscillations throughout the system.

In this paper micro-grid model is discussed in the second section of the, proposed control scheme is expressed in the third part of the. In the fourth and fifth sections system model and the equations of system in sliding mode and proposed control's equations are discussed, in Section VI the simulation results to verify the method of control is examined. Finally, the final conclusion is expressed.

## 2. Grid System Model

Fig.1 shows The general structure of a control of inverter distributed generator source , which includes the locally internal current and voltage controllers (low voltage , secondary voltage and frequency control), and filters are used also to filter and switching high frequency harmonic pwm and switching inverter from the filters, which includes a voltage source (pes) three-phase inverters, inductor-filter resistance between the inverter and the grid (coupling filter )design controller (The local controller)

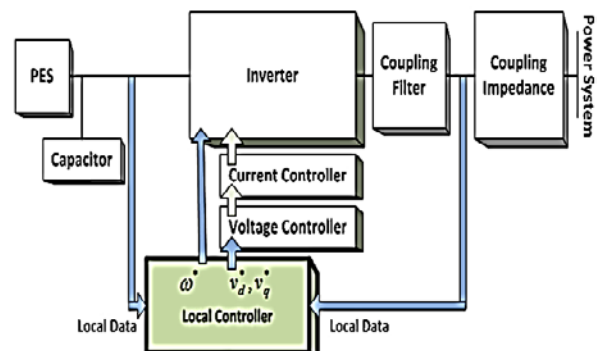


Fig.1. Micro grid model

The overall structure of a scattered source consists of three main units of primary actuator and one inverter, interfaced DC. There are two different control structures for inverter: PQ and VSI control. PQ is used the supply control for the actual and reactive power reference values, and can be used in variable the power factor of the grid in the case of a system. Often PQ structure is used when it is connected to the main structure. Because of the constant reference values, this structure does not have the ability to work in combination with other systems in variation conditions. However, VSI can also be used the island mode combination with in connected mode. In VSI control values are defined as reference and defined based on control and depending on the load, the active powers and reactive output (K. De Brabandere, 2007) VSI control is used in this paper.

### 3. Proposed controller

The main issue of control of power converters is the definition of a proper switching level for tracking the reference signal. And because of power switching, power inverters are compatible with sliding mode controllers. In this paper, to control the three-phase inverter voltage second-order sliding mode control is used which includes errors and trace error variations. Also adaptive control is also used for signal control improvement, avoiding large amplitude use for the signal control and estimating the upper bound of the instability and uncertainty. Also, based on Lyapunov stability condition, the stability and resistance of the system is analyzing. In fig 2

Equivalent model is obtained from the derivative of the sliding surface, and switching controller and adaptive control law. An equivalent controller of the model is derived from the specified parts of the inverter model, and the switching controller is used to ensure stability in the presence of an uncertainty and uncertainty that an equivalent controller cannot compensate for. A proportional controller is used to view the high boundaries of disturbances and to reduce the oscillations effect of high frequency of switching controllers.

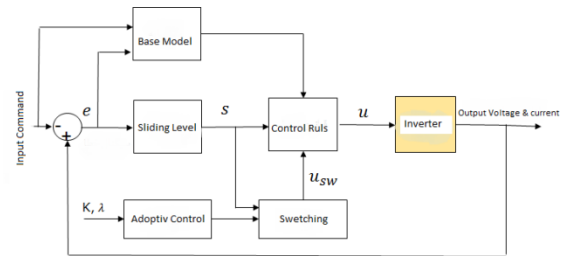


Fig.2. Proposed Control Diagram

### 4. Equation and model of system in island mode

According to fig.3 equations of the system are obtained in closed loop mode.

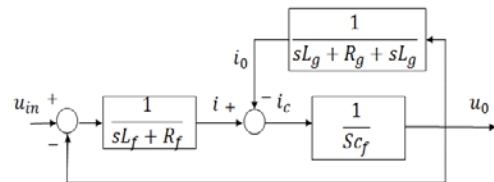


Fig.3. Block diagram of the grid in the island mode

The dynamics of the inverter system in island mode is based on the current and voltage and according to fig.3. is obtained according to kerchief current law:

$$L_f C_f \frac{d^2 u_o}{dt^2} + R_f C_f \frac{d u_o}{dt} + u_o + L_f \frac{d i_o}{dt} + R_f i_o = u_{in} \quad (1)$$

Which  $i_c$ ,  $i_0$  are capacitive and load filter respectively, are inductive, capacitive, and  $u_{in}$ ,  $u_0$  respectively represent the average output voltage of the output capacitor filter during switching.  $R_f$  shows the resistor equivalent in the inductor filter. And  $L_f$ ,  $C_f$  is the capacitance and inductor values.  $L_g$   $R_g$  is the inductance and resistance. In the equation(1)  $u_{in}$ ,  $u_0$  and,  $i_0$  is referred to as the three dynamic variables of the inverter system.

$$L_f C_f \frac{d^2 u_0}{dt^2} + R_f C_f \frac{du_0}{dt} + u_0 + d = u_{in} \quad (2)$$

while  $d$  is expressed as the external perturbation in terms of  $i_0$  and it is stated as  $d = L_f \frac{di_0}{dt} + R_f i_0$ .

Choosing  $u_0$  as the control system mode variable and  $u_{in}$  as the control input, the equation is as follows:

$$h_1 \ddot{u}_0 = h_2 \dot{u}_0 - u_0 - d + u_{in} \quad (3)$$

as we have:  $h_1 = L_f C_f$  and  $h_2 = -R_f C_f$

Assume that the internal parameters are known  $h_1$ , and  $h_2$  and there is no are not disturbed and  $d=0$ , and therefore the control law is designed to be as follows:

$$u_{in} = \left(\frac{h_1}{k_d}\right) \left(k_d \ddot{u}_r - \left(\frac{h_2}{h_1}\right) \dot{u}_0 + \left(\frac{1}{h_1}\right) u_0 - k_i e - k_p \dot{e}\right) \quad (4)$$

Where  $e$  shows the voltage error trace, and is defined as the form  $e$  where  $k$  is defined, as well as  $e = u_0 - u_r$ ,  $k_p$   $k_i$   $k_d$  are the slipping surface coefficients.

## 5. Design second order adaptive slider mode controller

The slipping surface and its derivative equation are defined as follows.

$$s = k_i \int e + k_p e + k_d \dot{e} \quad (5)$$

$$\begin{aligned} \dot{s} &= k_i e + k_p \dot{e} + k_d \ddot{e} \\ &= k_i e + k_p \dot{e} \\ &\quad + k_d \left( \frac{1}{h_1} (h_2 \dot{u}_0 - u_0 - d \right. \\ &\quad \left. + u_{in}) - \ddot{u}_r \right) \end{aligned}$$

For a controlled system, there are two types of uncertainties that cannot be ignored. The first is the disturbance which is defined earlier and the second is the uncertainty over the constant parameters of the dynamic system that reduces the accuracy of the inverter dynamic system model used in the design. Therefore, the main purpose for using this method is to increase the system's robustness in tracking the reference voltage despite the presence of perturbation and uncertainty. One of the ways to increase the resistance of the control system against these perturbations are to increase the switching gain in slip mode control, which in practice is not desirable due to high frequency oscillations with a large amplitude, and there is always a need to calculate the upper bound of the perturbation and uncertainty. This is also not desirable, so comparative control is used to estimate the upper bound of the perturbation.

The switching control law for controlling the slip model in a comparative and conventional manner is as follows:

$$u = u_{in} + \left(\frac{h_1}{k_d}\right) u_{sw} \quad (6)$$

$$u_{in} = -k_d^{-1} [h_1 (k_i e + k_p \dot{e} - k_d \ddot{u}_r) + h_2 k_d \dot{u}_0 - k_d u_0]$$

$$u_{sw} = -\hat{k} \cdot \text{sign}(s) \quad , \quad -\hat{k} \cdot \text{sat}(s)$$

Where  $\hat{k}$  is the estimated limit of uncertainty and perturbation and is in fact  $k$  The estimation error is defined in the form of

$\tilde{k} = \hat{k} - k$ . As the sign function is a discontinuous function. Due to the fact it causes chattering vibrate and this discontinuity causes noise and perturbation, to solve this problem in the grid, the control rule uses the continuous function (saturation) to be more stable. The comparative law is defined as follows:

$$\dot{\hat{k}} = \rho \cdot |s(t)| \quad (7)$$

Where we have  $\rho$  and  $\rho > 0$  the gain of comparative control is the estimation of perturbation upper bound law. We use the Lyapunov stability criterion to prove the stability of the adaptive control method. For this purpose, the Lyapunov function is candidate to be used to prove the stability:

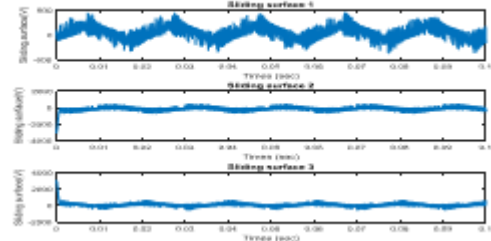
$$V(t) = \frac{1}{2} s^2(t) + \frac{1}{2} \tilde{k}^2(t) \quad (8)$$

$$\dot{V}(t) = s(t) \cdot (k_i e + k_p \dot{e} + k_d \ddot{e}) + \tilde{k} \dot{\tilde{k}} \quad (9)$$

Finally, by calculating the derivation of the Lyapunov function and placing slipping surface of and the control rule  $\dot{V}(t) < 0$ , the stability of the closed loop system and the upper bound perturbation is proved by considering Lyapunov stability law.

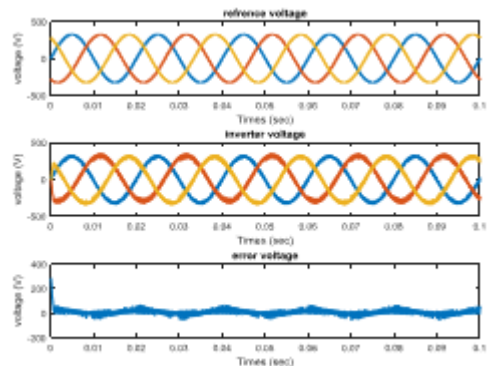
## 6. Simulation results

In this case, the inverter voltage control is considered by using the proposed controller applying turbulence to the network, which is a function of the inverter current. The purpose of examining the performance of proposed controller is in a way that the inverter output voltage waves form has a good ability to follow the reference three phase voltage waveform.



**Fig.4.** The graph of the slip surface of each phase of the inverter voltage

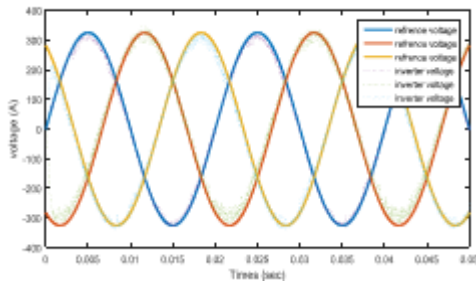
The diagram 4 shows the slipping level of each phase's inverter voltage shape of the. The existence of chattering is seen. As the significant problem of slipping mode control is chattering event which makes stimulates unstructured structures at high frequencies is inappropriate for a real system. derivative Control signal is used as the controller in this research and finally the control signal is obtained with integral which reduces the chattering event at high frequencies.



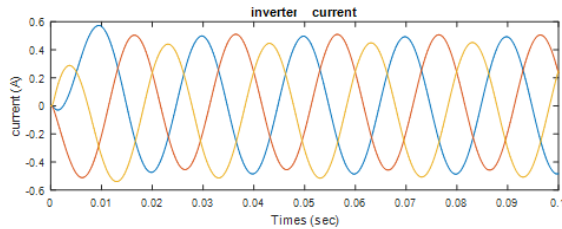
**Fig.5.** Reference voltages, inverter voltage and error voltage

The main purpose of using the controller in this approach, as mentioned above, is that the three phase inverter voltage can follows the reference voltages with the disturbances presence which results in error convergence and variations. Fig. 5 show the waveform of

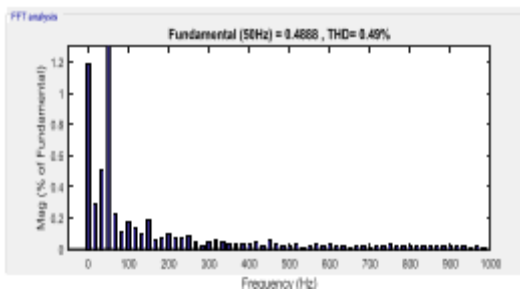
referenced three-phase voltage, inverter output 3-phase voltage the voltage difference from these two voltages are shown. As it is shown in fig.6, the inverter voltage greatly follows reference voltage with the presence of instability. The voltage error is convergent according to the waveform and goes to zero.



**Fig.6.** Comparison of reference voltages and inverter voltages

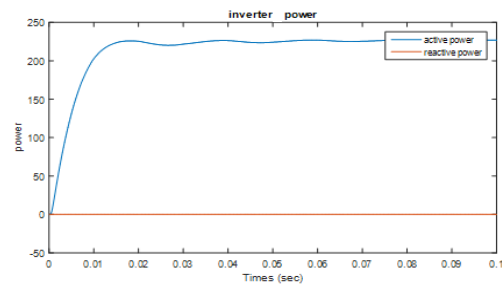


**Fig.7.**The shape of the inverter current waveforms



**Fig.8.**Total harmonic distortion for the inverter output current

The waveform of the inverter output current is shown in the figure7. The inverter output current is also very stable and, despite the low harmonic distortion, it is very close to the ideal condition. According to this, it can be stated that the proposed controller has a good robustness to the instability in the micro-network. the harmonic wave distortion of the inverter currents is completely identical for three cycles as it is shown figure8. As it can be seen, the total harmonic distortion for each of these two flows is 0.49, which is a very high which is indicative of an ideal sinusoidal waveform.



**Fig.9.** Active and reactive power inverter

Figure 9 show the inverter's active and reactive power by rms values according to this diagram, it can be seen that the reactive power of both inverters is well controlled and remains at zero. According to the results obtained, it can be stated that the controller has a good performance for stability. In spite of the instability of the current applied to the output voltage inverter circuit follows reference voltage. And obtained error from these two voltages converges to zero and the inverter output current is also fully stable. With keeping this in mind, the proposed controller can with situate the micro-network instability.

## 7. Conclusion

In this paper, the second-order adaptive Sliding Mode controller design is shown for the three-phase inverter in island mode that transient disturbances and additional harmonics and the chattering event have effectively been eliminated by the proposed method and the system quickly reaches to stable mode. And chattering caused by the slipping mode control was removed. Comparative control has been used in order to improve the slipping mode control and increase in system's robustness against disturbances and uncertainties of the model that estimates the degree of instability boundary to compensate the slipping mode Control method. Also, to demonstrate the efficiency and validity of this method, the Lyapunov stability analysis method has been used to show the stability of the system. The simulation results show that high precision tracking and the proposed controller has good robustness and good performance against instability in the grid.

Table. 1 Simulated System Parameters

Symbol	Quantity	Value
$V_{DC}$	Input dc voltage	400 v
$R_f$		0.5 ohm
$L_f$	Capacitive filter	0.001 F
$C_f$	Frequency	60 Hz
F	impedance	$0.5 + j0.01$ ohm
$Z_l$	load	$R=100$ ohm $L=0.5$ h
$R_1$	$K_{P123}$	10
	$K_{D123}$	1
	$K_{I123}$	10

## References

- [1] Dhananjay Gautam, Hema Rani M. Tech Scholar, Assistant Professor'' Microgrid System Advanced Control In Islanded and Grid Connected Mode'', 2014 IEEE International Conference
- [2] Vigneysh T, N Kumarappan, Senior Member, IEEE, and Arulraj R'' Operation and Control of Wind/Fuel Cell based Hybrid Microgrid in Grid Connected Mode'', 2013
- [3] Mao Meiqin; Sun Shujuan; Liuchen Chang, Economic analysis of the microgrid with multi-energy and electric vehicles'', Publication Year: 2011.
- [4] R. Aghatehrani, R. Kavasseri, Sensitivity-analysis-based sliding mode control for voltage regulation in microgrids, IEEE Trans. Sustain. Energy 4 (2013)
- [5] Rinu J Vijayan, Subrahmanyam Ch, Ranjit Roy'' Dynamic Modeling of Microgrid for Grid Connected and Intentional Islanding Operation'', 2012 IEEE
- [6] Abdolreza Esmaeli'' Stability analysis and control of microgrids by sliding mode control'' Electrical Power and Energy Systems, 2016 Elsevier.
- [7] Zhiyong Chen An Luo, Huajun Wang, Yandong Chen, Mingshen Li, Yuan Huang'' Adaptive sliding mode voltage control for inverter operating in islanded mode in microgrid'' Electrical Power and Energy Systems, 2015 Elsevier
- [8] Jalilzadeh Hamidi, H. Livani, S.H. Hosseini, G.B. Gharehpetian'' Distributed cooperative control system for smart microgrids'' 2015 Elsevier
- [9] K. De Brabandere, B. Bolsens, J. V. Keybus, A. Woyte, J. Driesen, and R. Belmans A voltage and frequency droop control method for parallel inverters'' IEEE Trans'' 2007
- [10] Siew-Chong, Tan Yuk-Ming Lai Chi Kong Tse ''Sliding Mode Control of Switching Power Converters'' 2012
- [11] Qing-Chang Zhong The University of Sheffield, UK Tomas Hornik Turbo Power Systems Ltd., UK'' control of power inverters in renewable energy and smart grid integration''

