

Research Paper

Three-Dimensional Simulation of A Steel Plate Deformation as Result of Underwater Shock Wave Using Fluid-Solid Interaction

A.J. Valdani, A. Adamian*

Department of Mechanical Engineering, Central Tehran Branch, Islamic Azad University, Tehran, Iran

Received 5 August 2023; accepted 27 August 2023

ABSTRACT

Present study considered deformation of a solid plate as result of external pressure wave. So, a detailed investigation of underwater explosions (UNDEX) and their effects on solid structures is the main objective of this paper. To accomplish this, numerical methods have been used to analyze the UNDEX structure qualitatively and quantitatively. Afterward, perpendicular blades are used to reinforce a marine structure. Governing equations in solid and fluid media were discretized using finite element and finite volume schemes, respectively. As for fluid-structure interaction (FSI), two-way coupling methods were used to map the results of fluid and solid media. The numerical method's validity can be confirmed by comparing numerical results with the analytical solution. Pressure-time diagrams follow the analytical solution reasonably well, indicating that the numerical method is valid. Additionally, results indicate that a pressure wave with amplitude of 20 MPa is generated by the detonation of explosive charge under water. Furthermore, reinforcement blades appear to reduce deformation in structures by increasing their resistance to explosive charges. These blades increase the strength of the plate where it could tolerate the Von-Mises stress up to 750 MPa.

© 2023 IAU, Arak Branch. All rights reserved.

Keywords: Numerical simulation; Deformation; Von-Mises Stress; Tension; Failure.

1 INTRODUCTION

VARIOUS analytical [1-4], experimental [4-6], and computational [4-9] research projects in the UNDEX field have been conducted due to the importance of water structures such as bridges, ships, and submarines. The numerical method is an effective tool because it requires a lower cost, produces extensive results, and can solve complex problems [9-11]. Due to these characteristics, the numerical method has become an important tool for researchers across a wide range of fields.

*Corresponding author. Tel.: +98 021 44600200, Fax: +98 021 44600200.
E-mail address: arm.jafaryvaldany@iauctb.ac.ir

UNDEX is being studied as a means of increasing the safety of two main types of marine structures: concrete structures (dams) and steel structures (ships and submarines). Linsbauer [12] studied concrete gravity dams under blast loading using the coupled model of water and dam reservoirs. For accurate predictions of UNDEX effects on concrete dams, Zhang et al. [13] studied material properties. To simulate the response of concrete dams against blast waves at heights of 30 to 142 m, appropriate grid generation in the finite element method and proper boundary conditions were determined. Numerical simulations were also used by Wang and Zhang [14] to predict the response of a typical concrete gravity dam to UNEX. Based on the results, critical curves were derived for different levels of damage. An investigation of the damage to ships caused by explosive charges was carried out by Zhang et al. [15] in the area of steel structures. In this study, experimental data was used to validate the numerical model, and then ship responses were simulated under various explosive scenarios. Based on the results, it can be concluded that the location of the explosive load directly affects the failure rate of a ship. The effect of UNDEX on steel structures was also studied by Fathallah et al. [16]. Various metal structures were simulated with the help of Abaqus software in this study. Ships and submarines can benefit from the results by optimizing floating structures in water. An analysis of blast waves from near-surface explosions was conducted by Wang et al. [17]. Rajendran [18] studied the elastic and plastic response of circular and rectangular plates using ANSYS/LS-DYNA. Qiankun and Gangyi [19] employed ABAQUS software to predict the shock response of a ship to non-contact UNDEX. The results emphasized that the grid size has a great impact on the accuracy of the numerical results.

An analysis of UNDEX's effects on structures was conducted using the Euler/Lagrange viewpoint and two-way FSI coupling method. Based on the results, it is evident that the boundary conditions of the free and structure surfaces have a significant influence on UNEX simulation results. An experimental and numerical study by Liu et al. [6] examined the effects of explosions on steel plates. According to the results, the strain rate should be taken into account when calculating the strength equation. LeBlanc and Shukla [20] used LS-DYNA software to simulate the effects of polyurea coatings on the UNDEX response of composite plates. The effects of fluid on the structure were considered utilizing a mesh that was equivalence at the boundary between the fluid domain and composite plate.

Detailed numerical simulations of the detonation wave were performed in the present study in order to investigate UNDEX. This paper first analyzes the blast wave's amplitude and velocity qualitatively and quantitatively. By simulating perpendicular blades on steel plates, we examined how well these stiffeners increase marine structure resistance to explosive loads in 3D.

2 METHODOLOGY

UNDEX examined wave propagation using geometries similar to those in analytic work [1]. A mathematical model for calculating pressure waves on 1D UNDEX was presented by Zamyshlyayev and Yakovlev [1]. Thus, 1 kg TNT was simulated numerically in water media, and the results were recorded at various time steps. As illustrated in Fig. 1, the problem is generally outlined. Monitor gauge points are indicated with symbols at distances of 2, 4, 6, and 8 m from the detonation point in the figure and the explosive charge's initial position is indicated with green.

There is spherical symmetry in the geometry and boundary conditions of this problem. Basically, only the radius affects the parameters. Hence, simulations are performed on the basis of spherical symmetry, which reduces the computational costs. This simplified 1D model shows that the green zone is where the TNT explosives are initially positioned, and the blue zone indicates where the water media are initially positioned, and its domain equals 10 meters (Fig. 2). By choosing this value, boundary conditions were not affecting numerical results. In this simulation, there were 100,000 elements, and the distance between nodes near the explosion site and at distances was 0.01 mm and 0.5 mm, respectively.

An analysis of the effects of the blast wave generated when a 7 kg TNT explosion is conducted at a distance of 5 meters from a barrier is presented in the second part of the paper. A diagram of the general geometry can be seen in Fig. 3 and Fig. 4. Hatched areas represent the outer surface of the barrier, which is a square steel plate with 3 m sides and a 20 mm thickness. There are nine stiffener blades on this plate. This figure shows the plate and its stiffeners in an isometric perspective. A perpendicular relationship exists between the stiffener blades.

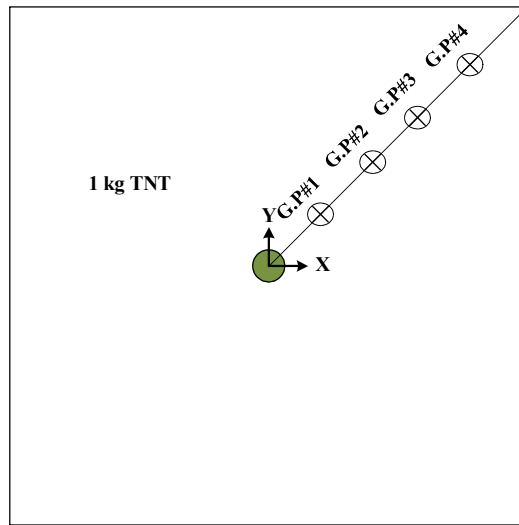

Fig.1
The general view of numerical domain.

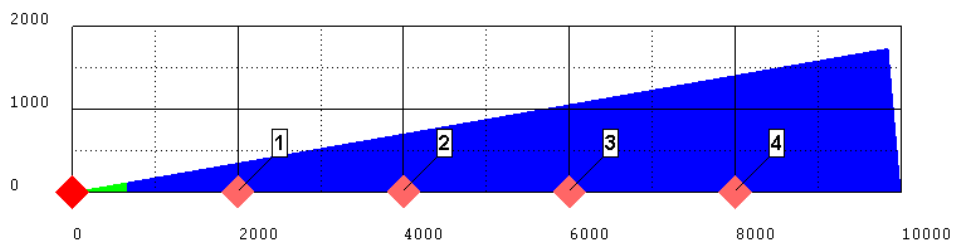

Fig.2
The 1D numerical model of the problem- TNT and water location are shown with green and blue colors.

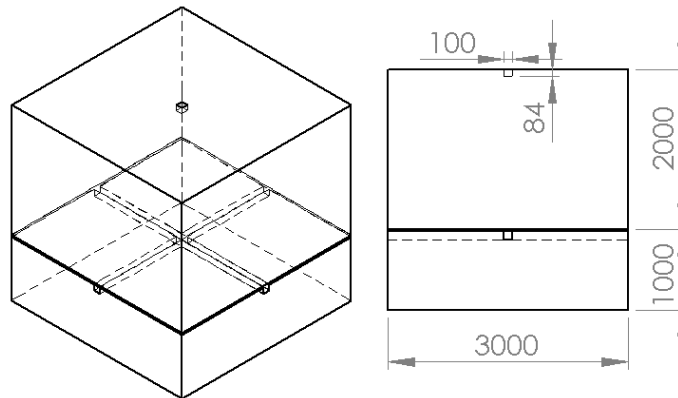

Fig.3
The general view of numerical domain.

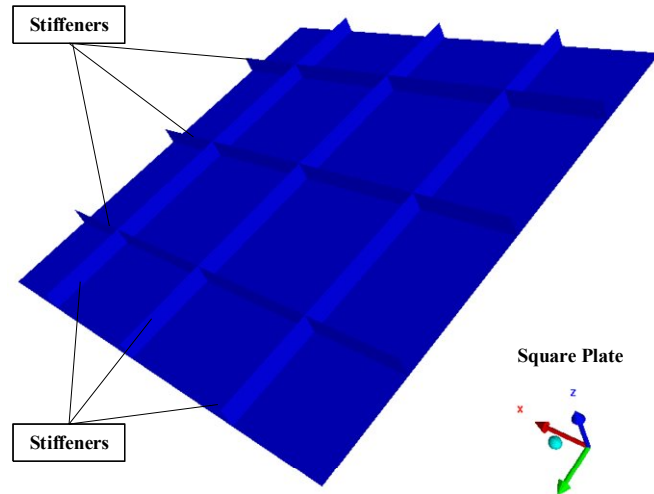

Fig.4
The 1D numerical model of the problem- TNT and water location are shown with green and blue colors.

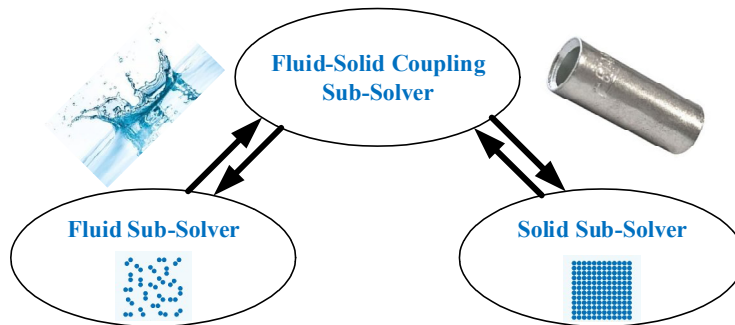

Fig.5
Connections between fluid, solid and coupling sub-solver on an FSI simulation.

In numerical methods, FSI must be considered because solid and fluid media interact and affect each other [21, 22]. In this method, the pressure, stress, and velocity distribution in the overall numerical domain are considered in terms of the interactions between the fluid and the structure by solving the governing equations of the fluid and solid media [23]. In fluid-structure coupling problems, the numerical method is divided into three smaller sub-solvers [24, 25]: fluid medium, solid medium, and coupling medium (Fig. 5). To increase the accuracy of the results, the third sub-solver uses the two-way (fully coupled) FSI algorithm. Numerical iteration on each time step considers the effects of fluid and solid media on each other. The iteration ends when neither fluid nor structure state changes, and the next time step begins.

As shown in the following equations [26-28], mass, momentum, and energy are all conserved in fluid media.

$$\frac{\partial \rho}{\partial t} + \nabla \cdot (\rho U) = 0 \tag{1}$$

$$\frac{\partial \rho U}{\partial t} + \nabla \cdot (\rho U * U) = \nabla \cdot (-\rho \delta + \mu(\nabla U + (\nabla U)^T)) + S_M \tag{2}$$

$$\frac{\partial \rho h_{tot}}{\partial t} - \frac{\partial P}{\partial t} + \nabla \cdot (\rho U h_{tot}) = \nabla \cdot (\lambda \nabla T) + S_E, \quad h_{tot} = h + 0.5(U^2), \quad h = h(P, T) \tag{3}$$

Among the variables in these equations, $\rho, t, U, P, \delta, \mu, h, \lambda, T$ are density, time, velocity, pressure, Kronecker delta function, viscosity, enthalpy, thermal conductivity, and fluid temperature. As well as S_E is the sum of external forces entering the fluid domain, and S_M is also the sum of internal forces.

Heat transfer is a major governing equation in solid media. The heat transfer equation in solid media can be expressed as follows [29], assuming conduction is the primary heat transfer method:

$$\frac{\partial \rho C_p T}{\partial t} = \nabla \cdot (\lambda \nabla T) + S_E \quad (4)$$

in which C_p and S_E are thermal capacity and heat production term in the solid media

3 RESULTS

In Fig. 6, the results of numerical simulation and analytical solution [1] are compared to qualitatively and quantitatively analyze the blast wave structure in UNDEX. This figure shows pressure-time curves at gauge points 1 to 4 (at distances of 2, 4, 6, and 8 m from the detonation point). Analytical results [1] are indicated in these graphs by red dots and numerical results by black lines. Just 1.2 ms after the explosion, the blast wave reached the first gauge point, where the pressure abruptly increased to 24 MPa. The pressure gradually decreased until it became equal to that of the ambient environment. Blast waves are created when explosives release instantaneously, which increases the surrounding temperature and pressure. During an explosion, there is an increase in pressure, which results in the formation of a shock wave in the environment with a speed of 1650 m/s. As a result, the blast wave moves at supersonic speed, and the targets downstream do not receive any warning that they are about to be destroyed. Gauge points 2 to 4 exhibit the same trend. At these points, eleven, seven, and five MPa of pressure amplitudes were reached. Additionally, a comparison between the analytical results [1] and the numerical results indicates that the pressure-time curves match reasonably well, confirming the validity of the numerical method.

The contours of pressure after the explosion are presented in Fig. 7 for qualitative analysis. Observations show that the water media creates compressive pressure waves instantly after the explosion. In less than 4 ms, the shock wave swept half of the mathematical domain at supersonic speed, so it kicked any targets in the media without notice. At $t=1.75$ ms, the pressure amplitude dropped gradually as the blast wave expanded in the environment and reached 8.5 MPa. Over time, the energy of the explosion are diminished and the pressure wave decayed.

The effect of explosive waves on steel structures reinforced with perpendicular blades was investigated after analyzing their structure and growth in water environments. Fig. 8 illustrates Von-Mises stress contours after an explosion of 7 kg TNT at a distance of 5 m from a plate. In the center of the reinforced steel plate, Von Mises stress increased abruptly for the first time. In the next step, the stress in the plate is penetrated to a larger area. A downward force is exerted on the plate as the explosion grows spatially. Thus, fixed boundaries have increased border stress. The plate has failed due to exceeding the yield stress and torn off at the corners ($t=9$ ms). Based on these results, we found that the stiffeners enhanced the strength of the plate and prevented the central parts of the plate from failing.

Following the explosion, Fig. 9 shows strain contours at different times. As it can be seen in this figure, firstly, the middle portion of the plate is deformed, and then with the growth of the pressure wave, the edges were also affected. At $t=12$ ms, the area near the fixed borders exceeded the limit and tore the corners. Also, it is obvious that over time the status of the plate are returned to elastic state.

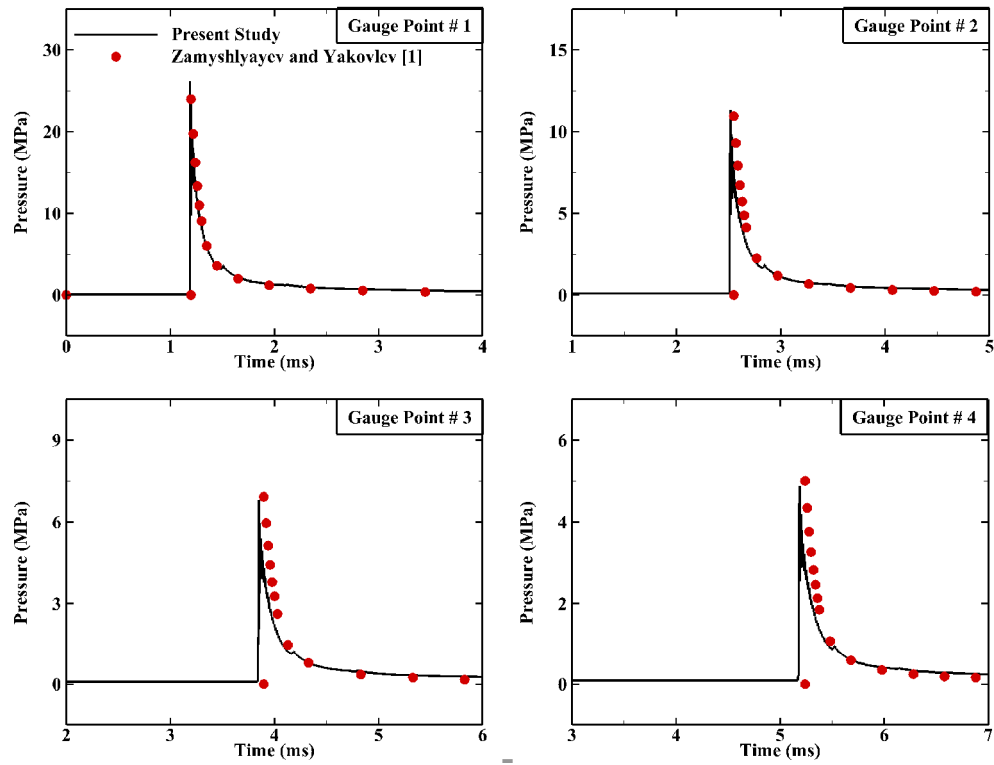

Fig.6
Validation of numerical method vs analytical results [1].

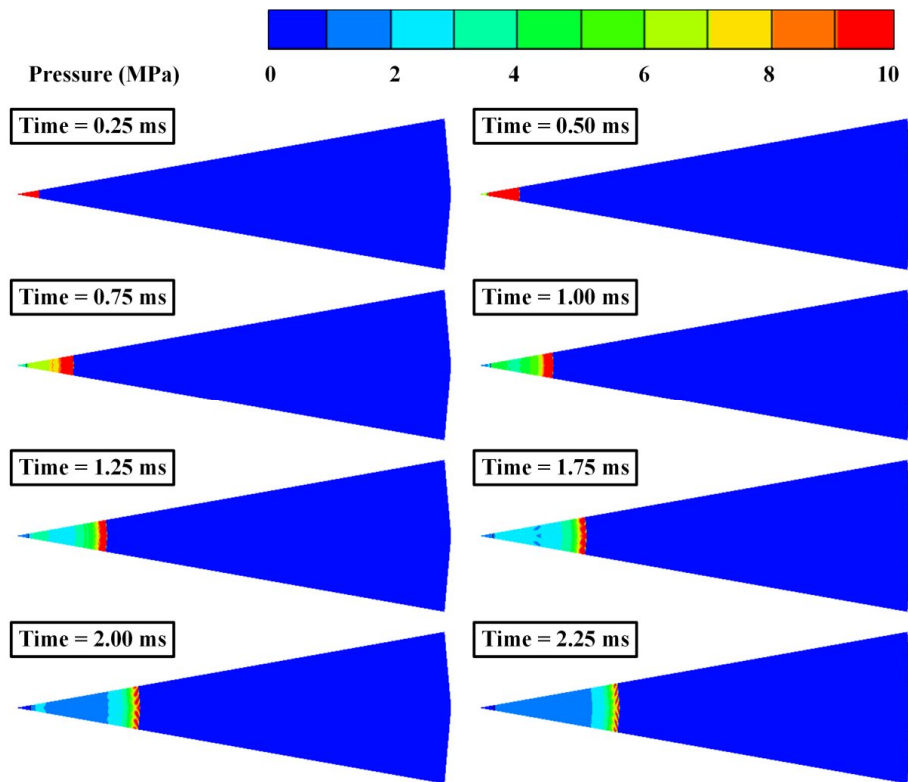

Fig.7
Contours of pressure waves.

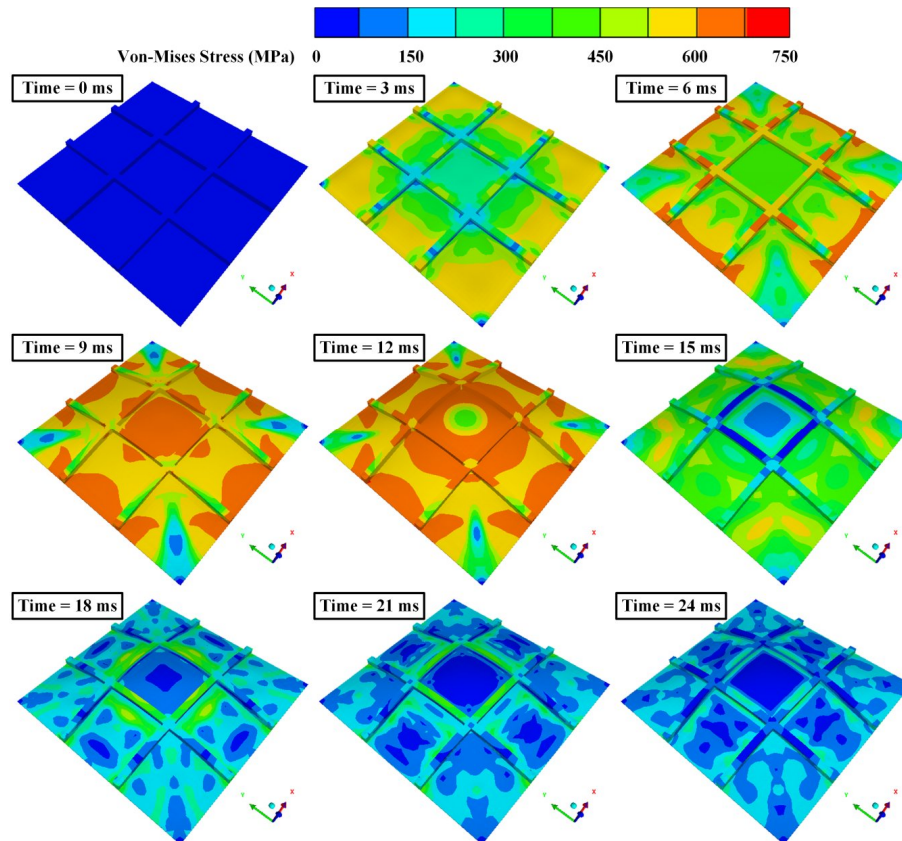

Fig.8
Contours of Von-Mises stress at different times after the pressure wave generation.

4 CONCLUSIONS

Numerical methods were used to study the shock wave generated by the explosion of TNT in water media and its effect on steel structures reinforced with perpendicular blades. An abrupt increase in pressure of 20 MPa is observed in UNEX when a supersonic pressure wave (with a velocity of about 1500 m/s) sweeps the water environment.. Additionally, FSI simulations indicate that when the explosive wave contacts the steel structure, it deviates and increases stress. According to the results, the stiffening effect of perpendicular blades increases the strength of the structure and decreases its deformation. According to the results, at $t=9$ ms, a maximum displacement of 75 mm (at $t=12$ ms) of the plate were observed with the explosion of 7 kg TNT at a distance of 5 m. Also, it was shown that the blades increase the strength of the plate up to 750 MPa.

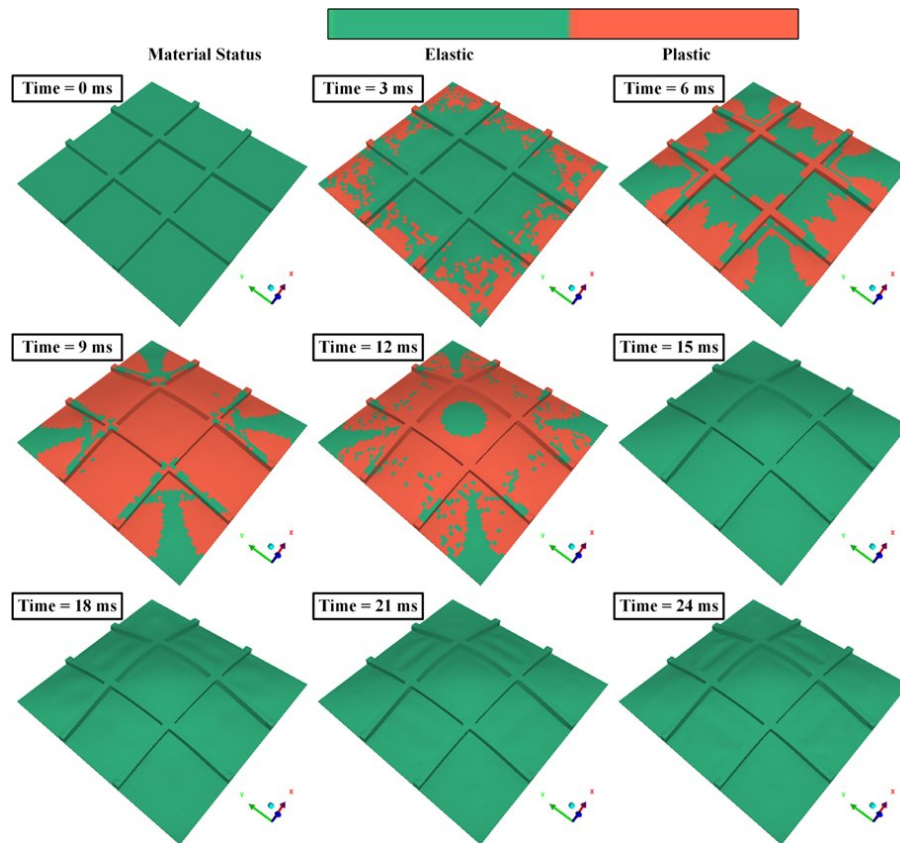

Fig.9
Contours of strain at different times after the pressure wave generation.

REFERENCES

- [1] Zamyshlyayev, B.V. and Y.S. Yakovlev, 1973, Dynamic loads in underwater explosion, Naval Intelligence Support Center Washington, D. C.
- [2] Qiu, X., V. Deshpande, and N. Fleck, 2004, Dynamic response of a clamped circular sandwich plate subject to shock loading. *Journal of Applied Mechanics*, 71(5): 637-645.
- [3] Fleck, N. and V. Deshpande, 2004, The resistance of clamped sandwich beams to shock loading, *Journal of applied mechanics*, 71(3): 386-401.
- [4] Ren, L., Ma, H., Shen, Z., and Wang, Y., 2019, Blast response of water-backed metallic sandwich panels subject to underwater explosion—Experimental and numerical investigations, *Composite Structures*, 209: 79-92.
- [5] Cao, W., Z. He, and W. Chen, 2014, Experimental study and numerical simulation of the afterburning of TNT by underwater explosion method, *Shock Waves*, 24(6): 619-624.
- [6] Liu, K., Wang, Z., Tang, W., Zhang, Y., and Wang, G., 2015, Experimental and numerical analysis of laterally impacted stiffened plates considering the effect of strain rate, *Ocean Engineering*, 99: 44-54.
- [7] Xin, C., X. Gengguang, and K. Liu, 2008, Numerical simulation of underwater explosion loads, *Transactions of Tianjin University*, 14(1): 519-522.
- [8] Zhang, Z., L. Wang, and V.V. Silberschmidt, 2017, Damage response of steel plate to underwater explosion: Effect of shaped charge liner, *International journal of impact engineering*, 103: 38-49.
- [9] Jin, Z., Yin, C., Chen, Y., and Hua, H., 2018, Numerical study on the interaction between underwater explosion bubble and a moveable plate with basic characteristics of a sandwich structure, *Ocean Engineering*, 164: 508-520.
- [10] Adibi, O., B. Farhanieh, and H. Afshin, 2017, Numerical study of heat and mass transfer in underexpanded sonic free jet, *International Journal of Heat and Technology*, 35(4): 959-968.
- [11] Gauch, E., J. LeBlanc, and A. Shukla, 2018, Near field underwater explosion response of polyurea coated composite cylinders, *Composite Structures*, 202: 836-852.
- [12] Linsbauer, H., 2011, Hazard potential of zones of weakness in gravity dams under impact loading conditions. *Frontiers of Architecture and Civil Engineering in China*, 5(1): 90-97.

- [13] Zhang, S., Wang, G., Wang, C., Pang, B., and Du, C., 2014, Numerical simulation of failure modes of concrete gravity dams subjected to underwater explosion, *Engineering failure analysis*, 36: 49-64.
- [14] Wang, G. and S. Zhang, 2014, Damage prediction of concrete gravity dams subjected to underwater explosion shock loading, *Engineering Failure Analysis*, 39: 72-91.
- [15] Zhang, A, Zeng, L., Wang, S., and Chen, Y., 2011, The evaluation method of total damage to ship in underwater explosion, *Applied Ocean Research*, 33(4): 240-251.
- [16] Fathallah, E., Qi, H., Tong, L., and Helal, M., 2014, Numerical simulation and response of stiffened plates subjected to noncontact underwater explosion. *Advances in Materials Science and Engineering*, 2014:1-17.
- [17] Wang, G., Zhang, S., Yu, M., Li, H., and Kong, Y., 2014, Investigation of the shock wave propagation characteristics and cavitation effects of underwater explosion near boundaries. *Applied Ocean Research*, 46: 40-53.
- [18] Rajendran, R., 2009, Numerical simulation of response of plane plates subjected to uniform primary shock loading of non-contact underwater explosion. *Materials & Design*, 30(4): 1000-1007.
- [19] Qiankun, J. and D. Gangyi, 2011, A finite element analysis of ship sections subjected to underwater explosion, *International Journal of Impact Engineering*, 38(7): 558-566.
- [20] LeBlanc, J. and Shukla, A., 2018, The Effects of Polyurea Coatings on the Underwater Explosive Response of Composite Plates, in *Blast Mitigation Strategies in Marine Composite and Sandwich Structures*, Springer.
- [21] Adibi, O., Rashidi, S., and Esfahani, J., 2020, Effects of perforated anchors on heat transfer intensification of turbulence nanofluid flow in a pipe, *Journal of Thermal Analysis and Calorimetry*, 141(5): 2047-2059.
- [22] Adibi, T, Razavi, S.E., and Adibi, O., 2020, A characteristic-based numerical simulation of water-titanium dioxide nanofluid in closed domains, *International Journal of Engineering*, 33(1): 158-163.23.
- [23] Hou, G., Wang, J., and Layton, A., 2012, Numerical methods for fluid-structure interaction-a review, *Communications in Computational Physics*, 12(2): 337-377.
- [24] Bungartz, H.-J., Mehl, M., and Schäfer, M., 2010, Fluid Structure Interaction II: Modelling, Simulation, Optimization. *Springer-Verlag Berlin Heidelberg*.
- [25] Adibi, O., Azadi, A., Frahanieh, B., and Afshin, H., 2017, A parametric study on the effects of surface explosions on buried high pressure gas pipelines, *Engineering Solid Mechanics*, 5(4): 225-244.
- [26] Çengel, Y.A. and Boles, M. A., 2002, Thermodynamics: An Engineering Approach, *McGraw-Hill*.
- [27] Adibi, T., Razavi, S. E., Adibi, O., Vajdi, M., Moghanlou, F. S., 2021, The response of nano-ceramic doped fluids in heat convection models: A characteristics-based numerical approach, *Scientia Iranica* 28(5), 2671-2683.
- [28] Adibi, T., Ahmed, S.F., Razavi, S. E., Adibi, O., Badruddin, I. A., and Javed, S., 2023, Impact of Artificial Compressibility on the Numerical Solution of Incompressible Nanofluid Flow, *Computers, Materials & Continua* 74(3).
- [29] Jo, J.C., 2004, Fluid-structure interactions. Korea Institute of Nuclear Safety, Republic of Korea.