

# Comprehensive Comparison and Evaluation of Channel Estimation Methods using Statistical Information Channel in OFDM System

Minoo Mosahebi<sup>1</sup>, Saeed Ghazi-Maghrebi<sup>2</sup>

1- Department of Electrical Engineering Faculty, Yadegar-e-Imam Khomeini (RAH) Shahr-e-Rey Branch, Islamic Azad University, Tehran, Iran.

Email: mosahebi.minoo@yahoo.com

2- Department of Electrical Engineering Faculty, Yadegar-e-Imam Khomeini (RAH) Shahr-e-Rey Branch, Islamic Azad University, Tehran, Iran

Email: s\_ghazi2002@yahoo.com

Received: November 2015

Revised: December 2015

Accepted: January 2016

## ABSTRACT:

Radio channel (wireless) including channels that are highly regarded and have been used. These channels are affected by the environment and change. Multipath propagation leads to rapid fluctuations of the phase and amplitude of the signal. In contrast to these channels, using Orthogonal Frequency Division Multiplexing (OFDM) technique is much better and more efficient. In order to access the basic information in the receiver, correct estimation impulse response is the main criterion. The current channel estimation methods can be classified into two categories. The first one is based on the pilots and the second one is not based on using pilot. A channel estimation method, the original channel estimation techniques using statistical information that are very useful and satisfying. This method provides our initial favorable data according to statistical information channel. In this paper presents, several common methods such as Wiener filter, Kalman filter and MMSE for channel estimation in OFDM system are evaluated and compared.

**KEYWORDS:** radio channel, multipath, channel estimation, statistical information channel

## 1. INTRODUCTION

The term channel refers to the medium between the transmitting antenna and the receiving antenna. The characteristics of wireless signal changes as it travels from the transmitter antenna to the receiver antenna. These characteristics depend upon the distance between the two antennas, the path(s) taken by the signal, and the environment (buildings and other objects) around the path. The profile of received signal can be obtained from that of the transmitted signal if we have a model of the medium between the two. This model of the medium is called channel model. The three key components of the channel response are path loss, shadowing, and multipath[1].

## 2. MULTIPATH CHANNEL

### 2.1. Propagation Aspects of Radio Channel

In wire-line communication, the data transmission is primarily corrupted by statistically independent Gaussian noise, as known as the classical additive white Gaussian noise (AWGN). In absence of interference, the primary source of performance degradation in such wire-line channels is thermal noise generated at the receiver. Reliable communication in

wireless or radio channels, however, becomes a difficult task as the transmitted data is not only corrupted by AWGN, but also suffers from inter-symbol interference (ISI), in addition to fading as well as interference from other users.

The wireless environment is highly unstable and fading is due to multipath propagation.

We assume that there are multiple propagation paths. Associated with each path is a propagation delay and an attenuation factor. Both the propagation delays and the attenuation factors are time-variant as a result of changes in the structure of the medium. Thus, the received band pass signal may be expressed as

$$y(t) = \sum_n a_n(t)x[t - \tau_n(t)] \quad (1)$$

Where  $a_n(t)$  is the attenuation factor for the signal received on the nth path and  $\tau_n(t)$  is the propagation delay for the nth path [2]-[3]-[4].

### 2.2. Fading

The fading in radio propagation can be classified into two groups: large-scale fading and small-scale fading. Large-scale fading manifests itself as the average signal

power attenuation or path loss due to motion over large areas. Small-scale fading refers to the dramatic changes in the signal amplitude and phase that occur due to small changes in the spatial separation between the transmitter and the receiver. In a typical wireless communications system, the transmitted signal typically undergoes refractions, shadowing and various reflections due to the presence of various objects (buildings, trees, etc.) in the channel [2].

### 2.3. Multipath Channel Parameters

#### ➤ Coherence bandwidth , Delay spread

The maximum delay after which the received signal becomes negligible is called maximum delay spread,  $\tau_{\max}$ . A large  $\tau_{\max}$  indicates a highly dispersive channel. Often root-mean-square (RMS) value of the delay-spread  $\tau_{rms}$  is used instead of the maximum. The coherent bandwidth ( $B_c$ ) is a statistical measurement of the range of frequencies over the flat channel and is reciprocally related to delay spread ( $T_d$ ), as [1]-[4]-[5]

$$B_c = \frac{1}{2T_d} \quad (2)$$

#### ➤ Doppler spread , Coherence time

Doppler spread and coherence time are parameters which explain the time-varying of the channel in a small-scale region. Doppler spread ( $B_d$ ) is the reciprocal of the coherence time ( $T_c$ ) of the channel, as [4]-[5]

$$T_c = \frac{1}{4B_d} \quad (3)$$

### 3. CHANNEL CHARACTERISTICS

#### ➤ Frequency-Selective, Frequency non Selective

Based on multipath time delay spread, small scale fading is classified as flat fading and frequency selective fading. If bandwidth of the signal is smaller than bandwidth of the channel and delay spread is smaller than relative symbol period then flat fading occurs whereas if bandwidth of the signal is greater than bandwidth of the channel and delay spread is greater than relative symbol period then frequency selective fading occurs.

#### ➤ Fast fading, slow fading

Based on doppler spread, small scale fading may be fast fading or slow fading. Slow fading occurs when the coherence time of the channel is larger relative to the delay constraint of the channel. The amplitude and phase change imposed by the channel can be considered roughly constant over the period of

use. Slow fading can be caused by events such as shadowing, where a large obstruction such as a hill or large building comes in the main signal path between the transmitter and the receiver. Fast fading occurs when the coherence time of the channel is small relative to the delay constraint of the channel [5]-[6].

### 4. OFDM

We discussed that when the signal bandwidth is much larger than the channel coherence bandwidth, the channel is frequency selective. We also explained that these channels present such impairments as intersymbol interference, which deform the shape of the transmitted pulse, risking the introduction of detection errors at the receiver. This impairment can be addressed with different techniques. One of these techniques is multicarrier modulation. In multicarrier modulation, the high bandwidth signal to be transmitted is divided over multiple mutually orthogonal signals of a bandwidth small enough such that the channel appears to be frequency non-selective. Among the many possible multicarrier modulation techniques, orthogonal frequency division multiplexing (OFDM) is possible and popular.

The input stream is divided and organized into blocks of  $N$  symbols, which are modulated into a single OFDM symbol. The resulting OFDM modulated symbol is

$$S(t) = \sum_{k=0}^{N_c-1} x_k \phi_k(t) \quad (4)$$

The  $x_k$  represents the symbols that are input to the OFDM modulator for transmission as a single OFDM symbol.

In (4) the signals  $\phi_k(t)$ , which are defined as

$$\phi_k(t) = \begin{cases} e^{j2\pi f_k t} & \rightarrow t = [0, T_s] \\ 0 & \rightarrow \text{otherwise} \end{cases} \quad (5)$$

We can write the resulting sampled signal  $s[n]$  as

$$s[n] = \sum_{k=0}^{N_c-1} x_k e^{j2\pi \frac{k}{N_c} n} \quad (6)$$

This result can be read as  $s[n]$  being the inverse Fourier transform of  $x_k$ , which is a simple way of generating an OFDM symbol and one of its main advantages. The OFDM symbol as defined in (6) is extended with the addition of a cyclic prefix. After adding the cyclic prefix:

$$s^t[n] = \begin{cases} s[N_c + n \rightarrow n = -N_{cp}, -N_{cp} + 1, \dots, -1 \\ s[n] \rightarrow n = 0, 1, \dots, N_c - 1 \end{cases} \quad (10)$$

$N_{cp}$  is the length of the cyclic prefix. Cyclic prefix is a copy of the last part of the OFDM symbol that is pre-appended to the transmitted symbol, as shown in Fig.1.

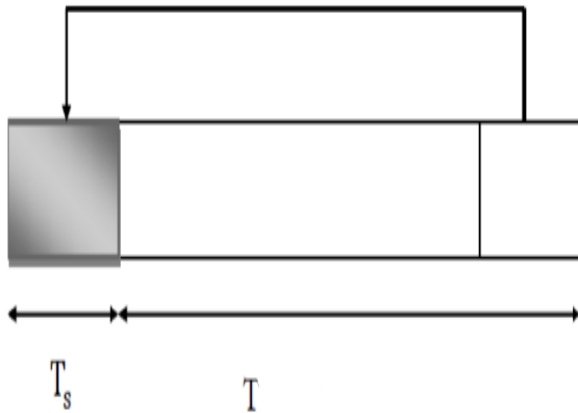

Fig. 1. Cyclic prefix

The output of the multi path channel can be written as:

$$y[n] = \sum_{\tau=0}^{N_{cp}-1} h[\tau]s[n-\tau] + z[n] \quad (11)$$

$$n = 0, \dots, N_c + N_{cp} - 1$$

After taking the discrete Fourier transform (DFT) of the received signal, the transmitted data samples can be calculated as

$$\tilde{x}_i[k] = \frac{Y[k]}{\hat{H}_i[k]} \quad (12)$$

Where  $\hat{H}[k]$  is estimated channel transfer function and  $Y[k]$  is the received signals [8]-[9].

5. CHANNEL ESTIMATION

Fig.2, presents an OFDM system that utilizes pilot-based channel estimation method for equalization at the receiver end. Different methods can then be applied to estimate the channel over all sub-carrier frequencies and not just at pilot sub-carrier frequencies.

Here we consider two major types of pilot arrangement.

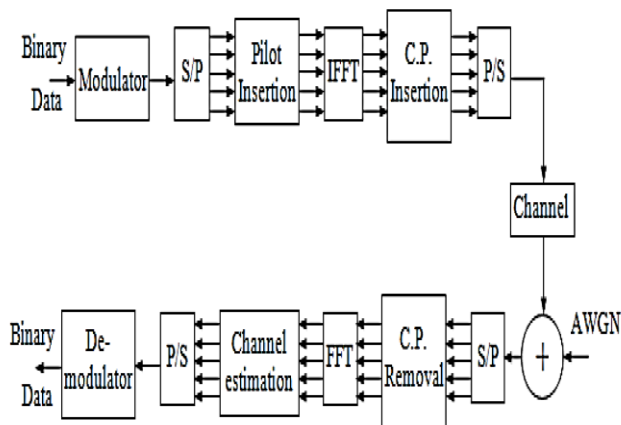

Fig. 2. Block diagram of an OFDM system.

5.1. Comb-Type Pilot

The pilot signals are uniformly distributed within each OFDM block. The comb-type pilot assignment has a higher re-transmission rate. Thus, the comb-type pilot arrangement system provides better resistance to fast-fading channels. The number of pilots used for channel estimation is usually much smaller than the number of sub-carriers.

In comb type channel estimation, after extracting the pilot signals from the received signal, the channel transfer function is estimated from the received pilot signals and the known pilot signals. The channel responses of data subcarriers can be estimated with the interpolation of pilot channel responses. The comb-type pilot channel estimation consists of algorithms to estimate the channel at pilot frequencies and to interpolate the channel.

5.2. Block-Type Pilot

The pilot signal is assigned to a particular OFDM block, which is sent periodically in time-domain. This type of pilot arrangement is especially suitable for slow-fading radio channels. The period of pilot insertion must be much smaller than the coherence time of the channel. The receiver uses the estimated channel conditions to decode the received data inside the block until the next pilot symbol arrives[2]-[10].

6. CHANNEL ESTIMATION METHODS USING STATISTICAL INFORMATION CHANNEL

6.1. Wiener Filter

Consider the situation in Fig. 3, where  $d(n)$  is the desired signal and  $x(n)$  is the input signal. The input  $x(n)$  is processed by a filter so that the output is  $y(n)$ . The estimation error, denote by  $e(n)$ , is defined as the difference between the desired response  $d(n)$  and the filter output  $y(n)$ . The goal is to find the impulse response coefficients of this filter that to make the estimation error  $e(n)$  as small as possible in some statistical sense.

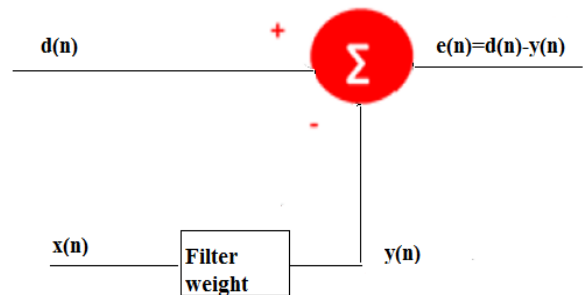

Fig. 3. Wiener filter

➤ **Cost function**

The statistical measure to be minimized is the expectation of a power of the absolute value of the error signal, i.e.  $E|e(n)|^k$ , where different values of the integer k result in different cost function or indicate performance:

k=1 expectation of the absolute value

k=2 square value or mean square error

k>2 expectation of a third or higher power of the absolute value

Mean square error (MSE) is most often used due to analytical tractability. to optimize the filter design, we choose to minimize the mean square value of the estimation error  $e(n)$ .

➤ **Principle of Orthogonality**

The filter output  $y(n)$  at discrete time n is defined by the linear convolution sum:

$$y(n) = \sum_{k=0}^{\infty} w_k^* u(n-k) \quad (13)$$

The k-th filter coefficient  $w_k$  be denoted in terms of its real and imaginary parts as follow:

$$w_k = a_k + jb_k \quad (14)$$

Accordingly, the estimation of  $d(n)$  is accompanied by an error, defined by the difference

$$e(n) = d(n) - y(n) \quad (15)$$

Thus define the cost function as the mean square error:

$$J = E[|e(n)|^2] = E[e(n)e^*(n)] \quad (16)$$

The minimum of MSE is obtained when the gradients are zero:

$$\nabla_k J = 0 \quad (17)$$

This results in the principle of orthogonality as follow:

$$E[u(n-k)e^*(n)] = 0 \quad (18)$$

$k = 0, 1, \dots$

By the principle of orthogonality:

$$E[y_o(n)e^*(n)] = 0 \quad (19)$$

With the optimal impulse response the estimation error is statistically uncorrelated with both input samples and output samples.

➤ **Wiener- Hopf equations[11]-[12]**

$$w_o = R^{-1}P \quad (20)$$

$$R = E[u(n)u^H(n)]$$

$$P(k) = E[u(n)d^*(n)]$$

The Wiener filtering or Linear Minimum Mean Squares (LMMSE) estimator tries to minimize the expected mean-squared error between the actual and estimated channel. The  $\hat{H}_{LMMSE,k}$ , estimate at k -th sub-carrier is

calculated by filtering the of pilot channel estimate vector by a Wiener filter as follows [2]:

$$\hat{H} = [\hat{H}_0 \quad \hat{H}_p \quad \dots \quad \hat{H}_{p(N_p-1)}]^T \quad (21)$$

$$C_{LMMSE} = [C_0 \quad C_1 \quad \dots \quad C_{N_p-1}]^T \quad (22)$$

$$\hat{H}_{LMMSE,k} = \sum_{i=0}^{N_p-1} C_i \hat{H}_{pi} = ((R_h + \sigma^2 I)^{-1} r)^H \hat{H} \quad (23)$$

## 6.2. Kalman Filter

The Kalman filter is a set of mathematical equations that provides an efficient computational (recursive) means to estimate the state of a process, in a way that minimizes the mean of the squared error. To estimate the state x of a discrete-time controlled process that is governed by the linear stochastic difference equation

$$x_k = Ax_{k-1} + Bu_{k-1} + w_{k-1} \quad (24)$$

With a measurement z that is

$$z_k = Hx_k + v_k \quad (25)$$

The random variables  $w_k$  and  $v_k$  represent the process and measurement noise (respectively). They are assumed to be independent (of each other), white, and with normal probability Distributions

$$P(w) \approx N(0, Q) \quad P(v) \approx N(0, R) \quad (26)$$

In practice, Q is the process noise covariance and R is the measurement noise covariance.

The  $n \times n$  matrix A in the difference (24) relates the state at the previous time step k-1. The  $n \times 1$  Matrix B relates the optional control input u to the state X to the state at the current step. The  $m \times n$  matrix H in the measurement (25) relates the state to the measurement  $z_k$ . In practice H and A might change with each time step or measurement, but here we assume it is constant.

### The Discrete Kalman Filter Algorithm

The Kalman filter estimates a process by using a form of feedback control: the filter estimates the process state at some time and then obtains feedback in the form of (noisy) measurements. As such, the equations for the Kalman filter fall into two groups: time update equations and measurement update equations. As shown below in Fig.4 and Fig. 5.

### The Computational Origins of the Filter

$\hat{x}_k^-$  to be our a priori state estimate at step k given knowledge of the process prior to step k.

$\hat{x}_k$  to be our a posterior state estimate at step k given

measurement  $z_k$ .

$$e_k^- \equiv x_k - \hat{x}_k^- \quad (27)$$

$$e_k \equiv x_k - \hat{x}_k \quad (28)$$

$$P_k^- = E[e_k^- e_k^{-T}] \quad (29)$$

$$P_k = E[e_k e_k^T] \quad (30)$$

$e^-_k$  and  $e_k$  are priori and posteriori estimate errors.

$P^-_k$  and  $P_k$  are priori estimate error covariance and the a posteriori estimate error covariance.

In deriving the equations for the kalman filter, we begin with the goal of finding an equation that computes an a posteriori state estimate  $\hat{x}_k$  as a linear combination of an a priori estimate  $\hat{x}^-_k$  as shown below in (31).

$$\hat{x}_k = \hat{x}^-_k + K(z_k - H\hat{x}^-_k) \quad (31)$$

$$K_k = p^-_k H^T (Hp^-_k H^T + R)^{-1} = \frac{P^-_k H^T}{Hp^-_k H^T + R} \quad (32)$$

The matrix  $m \times n$   $K$  in (32) is chosen to be the gain [13].

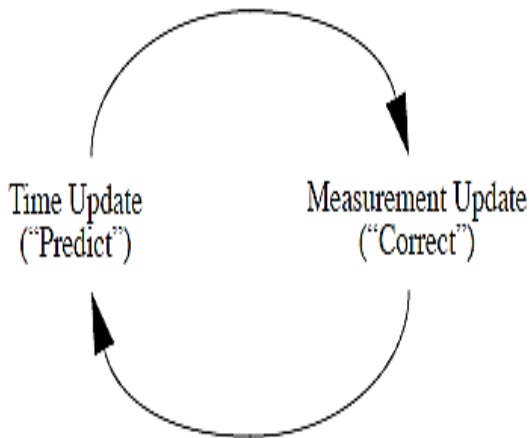

Fig. 4. Kalman filter cycle

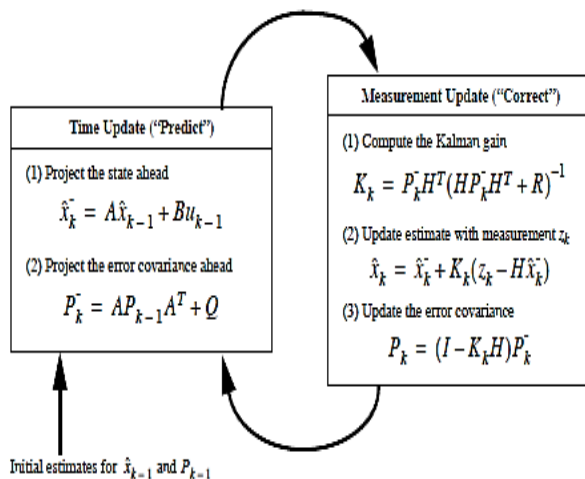

Fig. 5. Operation of the Kalman filter

### 6.3. MMSE

The MMSE has superior performance as compared to

the LS because it utilized second order channel statistics, which minimizes the MSE.

Where  $H$  denotes the actual channel estimation and  $\tilde{H}$  is raw channel estimation. MSE can be written as:

$$Y[|e|^2] = E[|H - \tilde{H}|^2] = E[(H - \tilde{H})(H - \tilde{H})^H] \quad (33)$$

$$\tilde{H}_{MMSE} = R_{HH} (R_{HH} + \sigma^2_N (x^H x)^{-1})^{-1} H_{p,LS} \quad (34)$$

Where  $R_{HH}$  and  $R_{YY}$  are the auto-covariance matrixes of  $H$  and  $Y$  respectively. While  $R_{HY}$  is cross-covariance matrix between  $H$  and  $Y$ .

Final expression for MMSE estimator is shown in (34), which requires matrix inversion that has to be calculated each time prior to estimation. Therefore MMSE is considered as a high computational complex estimator [8].

### 7. CONCLUSION

In this paper, we faced with a multipath channel and knowing with several techniques using statistical information, were our main goal. The study on these methods, obtained suitable formulations for the channel estimation and the data channel such as noise variance and autocorrelation function of the channel, are needed to use these formulas.

The simulation results in [9] and [14] illustrate that these methods as compared to methods that do not use statistical data channel, such as LS, are more complex but using these methods, the final data as compared to desirable data has less error.

So that with showing Fig.8 and Fig.9, method that its BER curve or its MSE curve is lower, has better result for us.

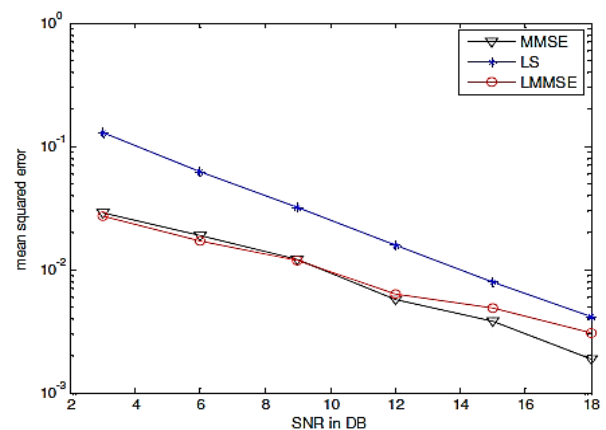

Fig. 6. Mean square error for LMMSE based estimator, LS based estimator and MMSE based estimator

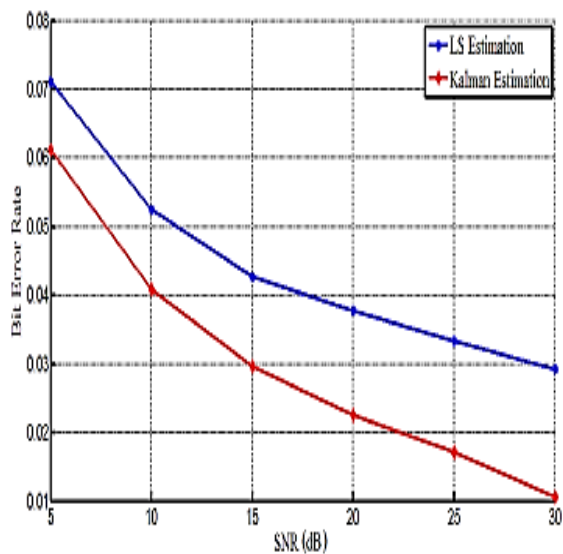

Fig. 7. Bit error rates for Kalman filter algorithm based estimator and LS based estimator

#### REFERENCES

- [1] R. Jain, "Channel Models A Tutorial", February 21, 2007.
- [2] M. Saad Akram, "Pilot-based Channel Estimation in OFDM Systems" 2007.
- [3] M.S. Chavan, R.H. Chile and S.R. Sawant, "Multipath Fading Channel Modeling and Performance Comparison of Wireless Channel Models", *International Journal of Electronics and Communication Engineering*, No. 2, 2011.
- [4] G. G. Proakis and Masoud Salehi, *Communications Systems Engineering*.
- [5] I. Pazi A. Supervisor & Examiner Dr. Joakim Jaldén, "Channel estimation in mobile wireless systems", 2012.
- [6] K. J. RAYLIU, "Cooperative Communications and Networking".
- [7] www.ni.com/white-paper, "OFDM and Multi-Channel Communication Systems", Nov. 05, 2014
- [8] A. M. Khan, Varun Jeoti, M. A. Zakariya, "Improved Pilot-based LS and MMSE Channel Estimation using DFT for DVB-T OFDM Systems", *IEEE 2013*.
- [9] A. Zaier1 and R. Bouallègue, "A Fullper formance Analysis of channels timing methods for time varying ofdm system", *International Journal of Mobile Network Communications & Telematics (IJMNCT)*, Vol. 1, No. 2, December 2011.
- [10] A. asadi and B. mozafari, "channel estimation by Wavelet transform in OFDM system", 1392.
- [11] Haykin, "Adaptive Filter".
- [12] V. Singh Chaudhary, Madhu Shandilya, "Channel Equalization using Weiner filter", *International Journal of Scientific Engineering and Technology 1* June. 2013.
- [13] Welch and Gary Bishop, "An Introduction to the Kalman Filter", July 24, 2006.
- [14] V, N Upadhyay, "Channel Estimation for OFDM Systems Using Kalman Filter Algorithm", 2008.