

# Investigating the Wind-induced effects on Tall Buildings to reduce Drag Coefficient through Large Eddy Simulation (LES)

<sup>1</sup>Najmeh Mastari Farahani, <sup>2</sup>Abdollah Baghaei Daemei, <sup>3</sup>Payam Madelat, <sup>4</sup>Seyedeh Maryam Abbaszadegan

<sup>1</sup> Faculty member and Instructor, Department of Architecture and Urbanism, Technical and Vocational University, Alborz, Iran.

<sup>2</sup> School of Built Environment, College of Science, Massey University, Auckland, New Zealand

<sup>3</sup> School of Engineering, Department of Civil Engineering and Architecture, Tallinn University of Technology, Estonia.

<sup>4</sup> Faculty of Architecture and Urbanism, Soore University, Tehran, Iran.

Received 28.05.2022; Accepted 19.08.2022

**ABSTRACT:** Wind load in architectural engineering can be defined as the natural load produced by air and is considered the most vital factor in design because this load significantly impacts structures, especially tall buildings. In this regard, drag force is the crucial wind force in tall building design. Even if the structure's safety is verified by using advanced technologies and high-quality materials, the vibrations caused by the wind force can still reach beyond the human comfort zone and may cause concern. The main goal of this study is to identify the wind aerodynamic factors in the urban boundary layer and evaluate the drag coefficient in tall-square buildings. Seven sample squared-plan buildings with aerodynamic modifications (corners), including recessed, rounded, and chamfered corners, and aerodynamic forms including set-back, tapered, and helical/twisted compared to the base (sharp corner) model were examined under simulation. Autodesk Flow Design 2014 software was employed as a wind tunnel simulator. The software utilizes a Large Eddy Simulation (LES) turbulence model solver to account for turbulence within the wind tunnel. LES is a mathematical model for turbulence used in computational fluid dynamics of the atmospheric boundary layer. The results showed that the sq6 with the aerodynamic tapered form had the best performance compared to other samples, successfully reducing the drag coefficient by about 50%. The sq3 sample with chamfered aerodynamic modification could also reduce the drag coefficient and wind effect by about 42%.

**Keywords:** *Wind aerodynamics, Urban boundary layer, Wind tunnel simulation, Drag coefficient, Tall buildings.*

## INTRODUCTION

Tall building design is challenging for engineers because they are prone to wind-induced vibration due to their flexibility, low inherent mechanical damping, slenderness, and light structure (Xie, 2014; Xu & Xie, 2015). As architectural design regards, not only wind loads but also the movements of the building as a result of wind blowing are both included in the area of design to assure the serviceability of the building (Elshaer et al., 2017). Nowadays, it is evident that the shape of the building mainly determines its behavior toward the wind. Considerations regarding aerodynamic shape optimization of buildings in the early stages of architecture have been proven as the most promising method for achieving a stable design against the wind (Tamura et al., 1998).

Stability design against the wind and aerodynamic optimization are the current topics in building design societies. Although the aerodynamic shape plays a vital role in designing tall buildings,

its optimization will not be achieved without dealing with other design aspects that limit the available options (Shiqing et al., 2017). One of the significant challenges in aerodynamic optimization is not seeking the best aerodynamic shape but achieving the optimized balance between aerodynamic performance and economic consequences. There are two main architectural design strategies for the aerodynamic optimization of tall buildings. Aerodynamic optimization can be divided into two categories: aerodynamic modifications and forms (Holmes, 2001; Yasa, 2016).

The first strategy is aerodynamic modifications which are usually considered numerical measures. Collaborative solutions can be used in tall building design by merging such approaches (Parker & Wood, 2013). Chamfering, rounding and recessing the corners of rectangular-shaped or square-shaped buildings are very common. This is recommended to be around 10 percent of the building width. Such a technique was tested

\*Corresponding Author Email: [abaghaei@massey.ac.nz](mailto:abaghaei@massey.ac.nz)

in the wind tunnel for the Taipei 101 tower with a height of 509 meters, resulting in a 25 percent reduction in wind forces (Irwin et al., 2008; Rafizadeh et al., 2022; Xie, 2012).

The other strategy is aerodynamic design with aerodynamic forms combined with an architectural design that significantly impacts the building shapes, including overall building height optimization such as making tapered, twisted/helical, and set-back (Wahrhaftig et al., 2013; Gunel & Ilgin, 2014). These solutions minimize the vibrations from wind in tall buildings and focus more on their shape, form, and cross-section at the design stage (Marsland et al., 2022). Moreover, for designing tall buildings against the wind, determining the type of reaction to the wind is very important; that defines the design method. Wind flow has three forces: along-wind motion, across-wind motion, and torsional-wind motion (Amin & Ahuja, 2014). In most tall buildings, the dynamic reaction to the along-wind motion dominates the design of loads and wind motions and sometimes leads to more vibration.

One of the most fundamental parameters in wind aerodynamics is the drag coefficient, which is done by optimizing the reaction of the along-wind motion by modifying the angles of the building (in the corners). However, there are very few studies conducted on the aerodynamic characteristics of tall buildings in Iran. Consequently, it is necessary to analyze tall building models by evaluating extensive building configurations as comprehensive guidelines for architects and engineers to make better decisions in the design of buildings. Since experimental measurements like wind tunnel test is expensive work, with high costs driven by specialized equipment and reagents, they have been profoundly time-consuming and expensive to use. On this basis, simulation and CFD software can give us a better understanding of the wind flow characteristics of tall buildings in urban areas. Thus, the primary aim of the present article is to identify which types of aerodynamic forms, like set-back, tapered, and helical/twisted, and modifications such as chamfered, rounded, and recessed corners can reduce the wind impacts on tall buildings.

## Research Background

In general, several studies have been conducted on aerodynamics and tall buildings. Some researchers have focused on wind design over tall rectangular buildings (Chan & Chui, 2006; Chan et al., 2009; Huang et al., 2011; Li et al., 2011). Kawai (1998) studied the effects of corner changes on the aeroelastic instability of tall buildings. The building model chosen for the study was square. The results showed that rounding has considerable effect in the first case compared with square form against the wind. Other records showed that if the amount of  $b/B$ , namely the percentage of recessing, is 0.05 percent, it can be highly suitable for the square plan.

Tamura and Miyagi (1999) analyzed the effect of turbulence on aerodynamic forces in a square plan with aerodynamic modifications at corners. The result showed that rounded and chamfered shapes could reduce drag force and the wake region.

In the following years, researchers conducted more extensive studies based on computational fluid dynamics in the form of simulation and empirical methods. In addition to reducing the costs of experiments, the simulation method allows researchers to assess more samples in shorter times. Kim and Kanda (2010) studied the characteristics of aerodynamic forces and pressure on a square plan building with height changes. The building was modeled with a square plan in the form of a tapered and set-back at height. This way, their set-back decreased by 5% and 10% in the tapered shape.

Kim et al. (2011) conducted a similar study on wind movement in tall buildings by changing the square plan in height. Two tapered models and a set-back model compared to the square models were examined. This study showed that set-backed and tapered models have lower torsional motion than the square mode. Tanaka et al. (2012) investigated the aerodynamic forces and wind pressure on tall buildings with unconventional configurations. In addition to designing context, the aerodynamics of tall buildings are seen from other aspects, namely pedestrian level wind, aeroelastic analyses, architectural additions, and airflow movement in urban areas (Cermak, 1975; Hu et al., 2006; Mendis et al., 2007; Kikitsu et al., 2008; Gu et al., 2010). Gu et al. (2014) studied the effects of aerodynamic modifications of buildings within the early stages of construction. Results show that chamfering can reduce the wind effect on tall buildings. In their study, Zhi et al. (2015) estimated wind forces on super tall buildings based on limited structural responses to optimize dynamic response and external loads. Warhaftig and da Silva's (2018) studies in tall residential buildings evaluated drag coefficient using computational fluid dynamics on an actual tall building.

Moreover, the aerodynamic modification technique has a 74 percent higher performance than wind aerodynamic shapes. In addition, various studies have been performed from the point of view of the effect of wind on a pedestrian level (Tominaga et al., 2008; Mochida & Lun, 2008; Mittal et al., 2018). Stathopoulos (2009) introduced design diagrams to improve the performance of tall buildings confronting wind in their study, focusing on the podium of the building and the pedestrian level.

## MATERIALS AND METHODS

### Configuration of the Simulation

This study uses computational fluid dynamics (CFD) to investigate wind aerodynamic factors. For this aim, the AutoCAD 2014 modeling software is used to produce the 3D model, and for applying the CFD method and wind tunnel simulation, the Autodesk Flow Design 2014 is utilized. The 3D model is exported in StL format from AutoCAD and imported for evaluation in simulator software. The wind flow type is along-wind motion, and the wind velocity in the wind tunnel is usually ten m/s. The solution method in the simulation software is based on Large Eddy Simulation (LES) for the turbulent flow in the wind tunnel. LES is a mathematical model for turbulent flow used for dynamic computational fluid dynamics in the

Table 1: Configuration of flow in the simulation software

Turbulent model	Wind tunnel section size	Flow rotation type	Flow velocity	Flow type	Simulation time	Flow status	Grid size (Resolution)
LES	300*300*1300	Along-wind motion	10 m/s	3D	40 sec.	Stabilized	150%

atmospheric boundary layer (Sullivan et al., 1994; Zhiyin, 2015). To increase the resolution and accuracy of simulation, grid generation is set at 150 percent, and wind flow is specified as 3D flow (Table 1).

This study uses a transient flow solver for simulation. Therefore, the flow rate is turbulent during the simulation, and output errors will be seen. The flow must be changed from transient to stabilized form to overcome this issue. When results vary depending on the model's size, flow velocity, and voxel size, the state will change from transient and turbulent to stable. This means that both flows are stable, and there will be no change in the case of physical transient flows; changes depending on time are repeated periodically. In other words, the flow will change from turbulent to uniform linear flow.

Autodesk Flow Design has conducted various evaluations compared to empirical studies for validation. The focal point of this software is on machines and architectural studies. To validate the wind tunnel simulator software, Autodesk (2015) developed research entitled "Flow Design Preliminary Validation Brief." This study is assessed with the results of the research presented by Fadl and Karadelis (2013). For this comparison, an actual building on Coventry University Central Campus was simulated in Flow Design and Fluent software under similar conditions. The results of this study showed

an offset error of about 6% compared to empirical data and computer simulations by Fluent, which makes the software results acceptable. Figure 1 depicts the framework.

### Theoretical Concepts of the Study

#### Wind Aerodynamics

Aerodynamic shape optimization is considered a useful method to increase the safety and serviceability of tall buildings against extreme winds. Aerodynamic optimization is conducted to increase structural stability against the wind. Wind force plays a crucial role in the design of tall buildings and will be even more critical than earthquake loads in some cases (Li et al., 2022). Design strategies of tall buildings for controlling the oscillations due to wind force can be divided into three major groups "architecture design approach," "structural approach," and "mechanical approach." From a structural design point of view, tall buildings, due to their height, are more sensitive to earthquake and wind loads due to the lateral forces than low-rise buildings (Zhou et al., 2022).

Since wind load can vary quickly and even abruptly (as opposed to living and dead loads), to estimate the wind load on buildings with more than 40 floors or aspect ratios of 6 and more, as well as buildings with unconventional forms, wind effect, and building response should be considered (Moreno,

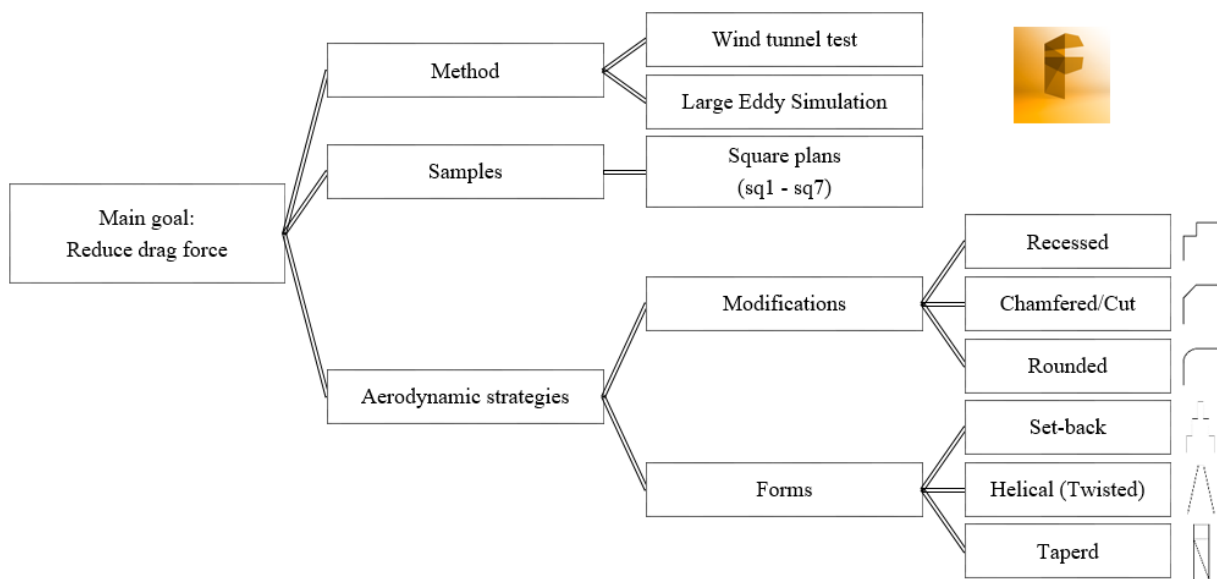

Fig. 1: Research theoretical framework

1989). The science of architectural aerodynamics in buildings always aims to reduce the "wind effect" on the building and reduce vertices generated on the lower floors, sides, and back of the buildings. Understanding the airflow pattern around the building is of great importance in design. Wind flow patterns in a tall building are the result of the shape of the building, wind characteristics, turbulence of the boundary layer, and the effects of adjacent buildings. Wind movement is usually horizontal and has less vertical behavior. However, in urban environments, the impact of "topography" on wind movement is crucial.

### Drag Force and Drag Coefficient

Drag force is the name given to the forces in physics and fluid dynamics that resist against movement of objects in fluids (Currie, 1974). In other words, drag force is a force against moving objects. Drag refers to a wind force or air resistance that exerts a force on moving objects against their moving direction, which is measured in Newton (N). It should be noted that these definitions apply to moving objects such as bicycles, birds, or automobiles. Based on NASA's report (2015), drag is a mechanical force produced by the interaction of a solid and a fluid (liquid or gas). To create the drag, a solid body should contact the fluid. If there are no fluids, there will be no drag force (Hall, 2015). On the other hand, drag is produced by the difference in velocity between a fluid and a solid. In such a way that there must be movement between the body and the fluid. If there is no movement, there will be no drag force. It does not matter that body moves across the fluid or the fluid moves over the solid body. Drag depends on fluid properties that include shape, size, and the body's velocity. The drag equation can be expressed as follows:

$$1) \text{ Drag equation: } F_D = \frac{1}{2} \rho v^2 C_D A$$

Where,

FD drag force;

ρ Fluid density;

V object's velocity relative to the fluid (In architecture, the fluid velocity is calculated);

CD drag coefficient;

A cross-section area (facing the wind);

\*Note: Air density at sea level, at 15 degrees Celsius, is around 1.225 kilograms per cubic meter (International Standard Atmosphere).

Drag is a force; therefore, it is a vector quantity with magnitude and direction. It can be imagined that drag is aerodynamic friction, and one of the factors that cause to produce drag is the skin friction between a fluid and a solid body. Since skin friction is the interaction of a fluid and a solid body, the magnitude of the friction depends on the properties of both materials, the solid and the fluid. In fluid mechanics, this friction is called the viscosity force, viscosity resistance, or viscosity. Table 2 summarizes the different shapes and the drag force exerted on them.

According to Table 2, it can be said that drag force is directly related to the form and shape of a solid body (here building). The less the area against the wall and its length along the fluid flow, the more Reynold's number, friction between air and the building, and consequently, the less drag force. But the smaller friction surface does not reduce the drag force. Perhaps this can be used in architecture. For example, when using the wind for natural ventilation, the friction surface between building and wind can be increased. An example of such a building designed with this feature, perhaps the Pirelli Tower in Milan, is one example (Figure 2). On the other hand, if the surface against the wind increases Reynold's number, the drag force on the building will increase in proportion.

In fluid dynamics, the drag coefficient, which is usually shown in the forms of (Cd, Cx, and Cw), is a dimensionless quantity for determining the drag force or the resistance of an object against a fluid such as water or air. In the drag equation (equation 1), the lower drag coefficient shows that an object has a lower aerodynamic drag. Therefore, it can be expressed that the drag coefficient always has a specific level (McCormick, 1979). Figure 3 depicts the drag coefficient for different shapes.

If we want to express an accurate definition of Reynold's number, it is a quantity in fluid mechanics that shows the ratio of inertia force to the viscosity force. In other words, the critical use of this number is to determine whether a flow is laminar or turbulent. If the Reynolds number is less than a specific amount (Re < 2100 or 2300), the flow is laminar, if the flow is changeable and in transition, it is (2300 < Re < 5000), and

Table 2: Presentation of different shapes and drag force acting on them

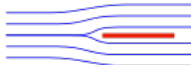
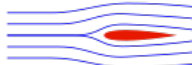
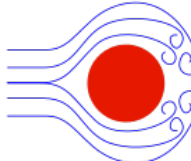
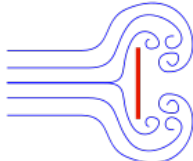
Shape and flow				
Pressure Drag (%)	0	~10	~90	100
Friction Drag (%)	100	~80	~10	0

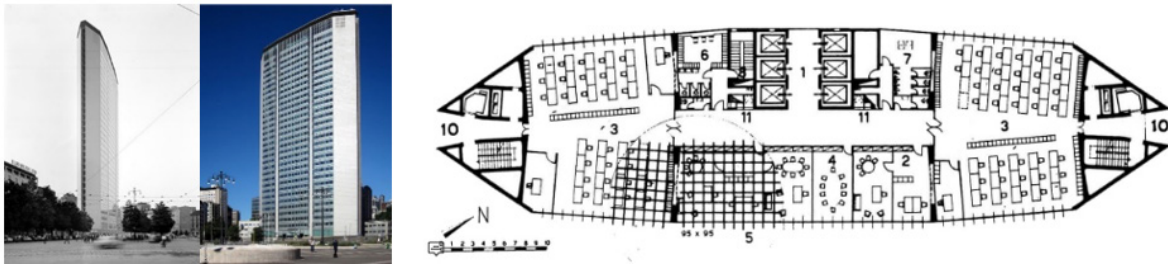

Fig. 2: Image and Plan of the Pirelli Tower

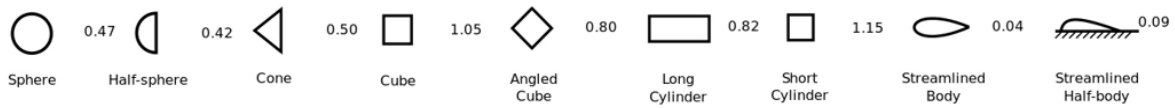

Fig. 3: Drag coefficient of various shapes

if it is ( $Re > 5000$ ), the flow is turbulent. This specific amount is called Critical Reynold's and shown with (Recritical) (Rott, 1990). Critical Reynold's number differs for each geometry (Potter et al., 2011). The mathematical definition of Reynold's number is:

2) Reynold's number equation: 
$$Re = \frac{\rho v L}{\mu}$$

Where:

- $\rho$  fluid density;
- $V$  Mean fluid velocity;
- $L$  Characteristic length in the problem;
- $\mu$  Viscosity of fluid.

### Wake Region

The critical point in studying Reynold's number is the characteristic length of Reynold's or the wake region. In

turbulent flow, the typical size is the distance in which a correlation exists between flow parameters such as velocity or pressure. However, since these correlations do not have the same frequency, a turbulent flow has different characteristic lengths. Considerable typical sizes correspond to low frequencies and vice versa (Figure 4).

### Set-Back and Tapered Forms

In urban environments, topography will have an impact on wind flow. Since the earth's surface is rough, the wind velocity decreases near the surface due to the viscous friction. With distance from the ground surface, the friction force decreases by reducing the topography and roughness of the air flow in the urban boundary layer (Arakeri & Shankar, 2000). With the increase in altitude, the wind velocity also increases, which can be seen as a direct relationship between the increase in height and wind velocity. One of the ideas that architects can come up with is to reduce surface exposure to the wind. In this case,

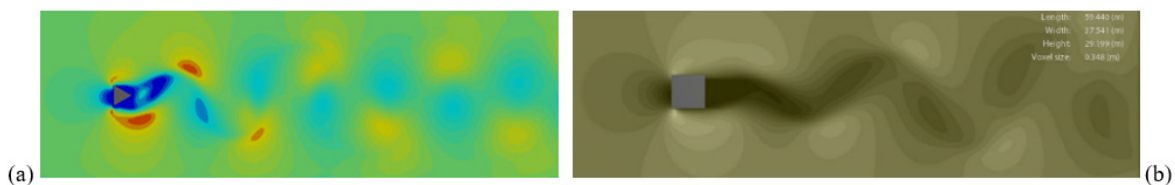

Fig. 4: Visualization of turbulent Reynold's of a triangle-shaped object (a) and a cubic-shaped object (b)

Table 3: Real case studies designed through set-back and tapered (Baghaei Daemei et al., 2019)

							
Burj Khalifa	Trump International Hotel & Tower	Willis Tower	Transamerica Pyramid	Bahrain World Trade Center	The Lotte World Tower	The Shard	30 St Mary Axe

Table 4: Real case studies in which plan variations were applied to the form and cross-section (Baghaei Daemei et al., 2019)

							
Absolute World	Turning Torso	Cayan Tower	Shanghai Tower	Diamond Tower	Evolution Tower	Dynamic Tower	Tokyo Mode Gakuen

the cross-section of the building is wider on the lower floors, and its area will gradually decrease. Since the wind velocity is stronger at the top of buildings, this technique decreases the building envelope exposure to the wind, and as a result, the effect of the wind on the building is also reduced. This technique was carried out in the Burj Khalifa with an architectural height of 828 meters (Parker & Wood, 2013). Other examples of such buildings can be seen in Table 3.

#### Plan Variation

Plan variation of the cross-section at the height causes the frequency of the wind effect to change gradually. Due to the different geometries of the building in the form, the properties of the vortex will also change at the height, and there will be less wind effect on buildings. A great example is the Shanghai Tower, with a height of 632 meters and a triangular cross-section, which, in addition to gradually decreasing, changes its angle by 120 degrees from the bottom to the top. As a result, presenting different shapes and widths reduces the effect of the wind. It indicates a reduction of about 15% of wind load (Xie, 2012). As stated, these techniques have reduced wind exposure (Table 4).

## RESULTS AND DISCUSSION

### Wind Tunnel Simulation in Tall Buildings

In this study, seven tall buildings with square plans were studied. This simulation's main goal was to evaluate each

model's drag coefficient and force to determine which square plans could show the lowest drag. The method for reducing drag is using aerodynamic modifications and aerodynamic forms. Aerodynamic modifications that are applied on corners include base form/sharp (sq1), rounded (sq2), chamfered corners/cut (sq3), recessed (sq4), and aerodynamic forms that are applied on the whole building height, including set-back (sq5), tapered (sq6), and helical/twisted (sq7). The width (b) is 25 meters, and the height (H) is 125 meters (35-floor building), so the ratio of b to h is 1 to 5. The amount of aerodynamic modification is  $b=1/10$ . Sample sq7 has a 45-degree rotation from the center, and the height decreasing proportions (stepping) in sample sq5 has the ratio of  $b=1/10$ . The wind is considered as along-wind perpendicular to the building. In Figure 5, these samples are shown with the corresponding ratios.

Samples are imported with an STL file format in the simulation software and the wind tunnel to calculate the drag force and coefficient. The simulation time and the duration of the transition from turbulent to stable flow are 40 seconds. Input information in all samples was set the same. The following are the simulation results (Table 5).

Table 5 shows the drag coefficient, drag force, and mean drag force. Based on this, base model sq1 has the highest drag coefficient since it does not have any aerodynamic optimization. Sample sq6 with the tapered form performs best in reducing drag coefficient. This can be extracted comparatively in Figure 6.

In the following, each method for solving aerodynamic

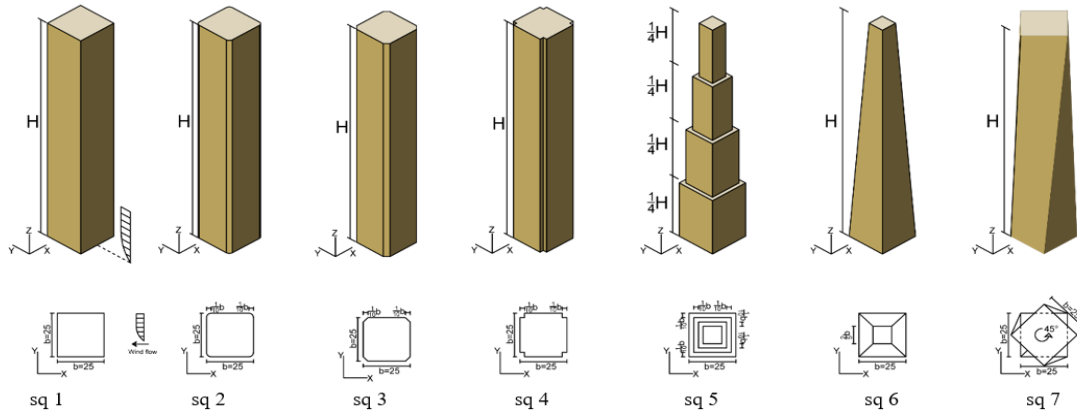

Fig. 5: Sample buildings details with dimensions, ratios, and wind direction

Table 5: Simulation Results

State	Drag force	Drag Coefficient	Time (second)	Sample
Stabilized	0.325	1.01	40	sq1
Stabilized	0.199	0.66	40	sq2
Stabilized	0.117	0.58	40	sq3
Stabilized	0.199	0.69	40	sq4
Stabilized	0.238	1.06	40	sq5
Stabilized	0.108	0.51	40	sq6
Stabilized	0.211	0.73	40	sq7

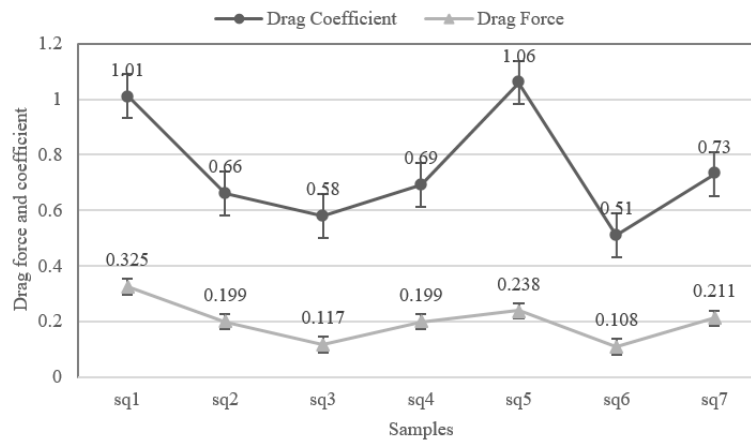

Fig. 6: Comparison of drag force and drag coefficient of building samples

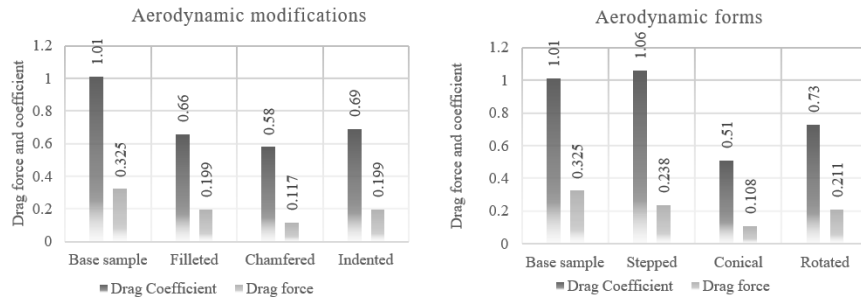

Fig. 7: Comparison of drag coefficient in aerodynamic modifications and forms in all samples

modifications and forms is analyzed separately to determine which method has the best drag reduction performance. In this way, all models are first compared with the base sample, the type of the solution method, and then compared with each other. Thus, the sq1 model with a drag coefficient of 1.01 has the highest amount. However, the effect of aerodynamic modifications in reducing drag coefficient in the sq2, sq3, and sq4 samples include 0.66, 0.58, and 0.69, respectively. Aerodynamic forms also include the samples sq5, sq6, and sq7, in which the drag coefficients are 1.06, 0.51, and 0.73, respectively (Figure 7).

According to Figure 7, it can be seen that chamfered aerodynamic modifications in sq3 with 0.85 Cd and sq6 tapered aerodynamic form with 0.51 Cd could have the best performance compared to other samples.

## CONCLUSION

Due to the importance of tall buildings' design against wind-induced, paying close attention to the form of these buildings is inevitable in the early stages of design. Because not paying attention to it can have irreparable consequences. The primary purpose of this study is to identify which types of aerodynamic forms and modifications can reduce the wind impacts on tall buildings. The present study assessed the drag coefficient in 7 tall squared-plan samples through wind tunnel simulation. The strategies were applied to the samples' forms and shapes: chamfered, recessed, and rounded corners as the aerodynamic modifications, set-back, tapered and helical/twisted as the aerodynamic forms. This simulation aimed to determine the suitable tall buildings' forms and shapes. These strategies allow the building surface to be exposed to wind-induced. On the other hand, they can lead wind flow to move smoothly around the buildings in urban areas.

The results showed that the sample sq6 with tapered aerodynamic form could have a suitable performance in reducing the drag coefficient by 0.51 Cd compared to the sharp sample (base) of sq1 by about 1.01 Cd. It means the sq6 sample will have about a 50% wind effect reduction compared to the

sq1 sample. The sq6 had 22%, 12%, 26%, 51%, and 30% appropriate performance in reducing the drag coefficient than the sq2 to sq7 samples. In the following, the performance of the best sample in aerodynamic modification and form was compared. Thus, the sq3 sample with the amount of 0.58 Cd reduced the coefficient by about 12% and about 16% compared to the sample sq2 with a rounded corner and the sample sq4 with a recessed corner, respectively. However, the performance of the sample sq6 with the tapered aerodynamic form in height and the sample sq3 with chamfered aerodynamic modification in the corners could have the best performance in reducing the drag coefficient by about 12%. Consequently, based on the simulation results, it is suggested that for tall building design with a square plan, in the urban boundary layer where the wind velocity is about 10 m/s, the chamfered aerodynamic modification and the tapered aerodynamic form can reduce wind effects significantly.

## AUTHOR CONTRIBUTIONS

N Mastari Farahani performed the research and investigation process, provision of study materials, and preparation, creation, and presentation of the published work by those from the original research group. A Baghaei Daemei performed the oversight and leadership responsibility for the research activity planning and execution, including mentorship external to the core team, development or design of methodology, creation of models, and simulation. P Madelat performed the preparation, creation, and presentation of the published work, specifically writing the initial draft (including substantive translation) and preparation, creation, and presentation of the published work by those from the original research group, specifically critical review, commentary, or revision – including pre-or post-publication stages. M Abbaszadegan performed the critical review, commentary, or revision – including pre-or post-publication stages. All authors provided critical feedback and helped shape the research, analysis and manuscript.

## CONFLICT OF INTEREST

The authors declare no potential conflict of interest regarding the publication of this work. In addition, the ethical issues, including



plagiarism, informed consent, misconduct, data fabrication and, or falsification, double publication and, or submission, and redundancy, have been completely witnessed by the authors.

## REFERENCES

- Amin, J.A. Ahuja, A.K. (2014). Characteristics of wind forces and responses of rectangular tall buildings. *International Journal of Advanced Structural Engineering*, 6(3), 66.
- Arakeri, J. H. & Shankar, P. N. (2000). Ludwig Prandtl and boundary layers in fluid flow. *Resonance*, 5(12), 48-63.
- Cermak, J.E. (1975). Applications of fluid mechanics to wind engineering—a Freeman Scholar lecture. *Journal of Fluids Engineering*. 97(1), 9–38.
- Chan, C.M., & Chui, J.K.L. (2006). Wind-induced response and serviceability design optimization of tall steel buildings. *Engineering Structures*, 28 (4), 503–513.
- Chan, C.M., Huang, M.F., Kwok, & K.C.S. (2009). Stiffness optimization for wind-induced dynamic serviceability design of tall buildings. *Journal of Structural Engineering*, 135 (8), 985–997.
- Currie, I. G. (1974). *Fundamental Mechanics of Fluids*, McGraw-Hill, Inc.
- Davenport, A.G. (1971). The response of six building shapes to turbulent wind. *Royal Society*, 269, 385–394.
- Elshaer, A., Gairola, A., Adamek, K., & Bitsuamlak, G. (2017). Variations in wind load on tall buildings due to urban development. *Sustainable Cities and Society*, 34, 264-277.
- Fadl, M.S. & Karadelis, J.N. (2013). CFD simulation for wind comfort and safety in urban area: a case study of Coventry university central campus. *International Journal of Architecture. Engineering and Construction (IJAEC)*, 2(2), 131-143.
- Autodesk (2014). Flow Design Preliminary Validation Brief, Retrieved from: [http://download.autodesk.com/us/flow\\_design/Flow\\_Design\\_Preliminary\\_Validation\\_Brief\\_01072014.pdf](http://download.autodesk.com/us/flow_design/Flow_Design_Preliminary_Validation_Brief_01072014.pdf).
- Gu, M., Huang, P., Tao, L., Zhou, X., & Fan, Z. (2010). Experimental study on wind loading on a complicated group-tower. *Journal of Fluids and Structures*, 26, 1142–1154.
- Gu, M., Cao, H.L., & Quan, Y. (2014). Experimental study of across-wind aerodynamic damping of super high-rise buildings with aerodynamically modified square cross-sections. *The Structural Design of Tall and Special Buildings*. 23, 1225–1245.
- Günel, M.H., & Ilgin, H.E. (2014). *Tall Buildings Structural Systems and Aerodynamic Form*, First published, Routledge, Taylor & Francis Group, New York.
- Holmes, J.D. (2001). *Wind Loading of Structures*, London: Spon Press.
- Hu, J.C., Zhou, Y., & Dalton, Y.C. (2006). Effects of the corner radius on the near wake of a square prism. *Experiments in Fluids*, 40, 106–118.
- Huang, M.F., Chan, C.M., & Kwok, K.C.S. (2011). Occupant comfort evaluation and wind induced serviceability design optimization of tall buildings. *Wind and Structures*, 14 (6), 559–582.
- Rafizadeh, H., Alaghmandan, M., Tabasi, S. F., & Banhashemi, S. (2022). Aerodynamic behavior of supertall buildings with three-fold rotational symmetric plan shapes: A case study. *Wind and Structures*, 34 (5), 407–419.
- Irwin, P.A., Kilpatrick, J., Robinson, J., & Frisque, A. (2008). Wind and Tall Buildings: Negatives and Positives. *Structural Design of Tall and Special Buildings*. 17, 915–928.
- Kawai, H. (1998). Effect of corner modifications on aeroelastic instabilities of tall buildings. *Journal of Wind Engineering and Industrial Aerodynamics*, 74(76), 719-729.
- Kikitsu, H., Okuda, Y., Ohashi, M., & Kanda, J. (2008). POD analysis of wind velocity field in the wake region behind vibrating three-dimensional square prism. *Journal of Wind Engineering and Industrial Aerodynamics*, 96, 2093–2103.
- Kim, Y., and Kanda, J. (2010). Characteristics of aerodynamic forces and pressures on square plan buildings with height variations. *Journal of Wind Engineering and Industrial Aerodynamics*, 98(8–9), 449-465.
- Kim, Y.C., Kanda, J., & Tamura, Y. (2011). Wind-induced coupled motion of tall buildings with varying square plan with height. *Journal of Wind Engineering and Industrial Aerodynamics*, 99(5), 638-650.
- Li, Q.S., Zou, X.K., Wu, J.R., & Wang, Q. (2011). Integrated wind-induced response analysis and design optimization of tall steel building using micro-GA. *Struct. Des. The Structural Design of Tall and Special Buildings*, 20, 951–971.
- McCormick, B.W. (1979). *Aerodynamics, Aeronautics, and Flight Mechanics*. New York: John Wiley & Sons, Inc.
- Mendis, P., Ngo, T., Haritos, N., & Hira, A., (2007). Wind loadings on tall buildings. *EJSE Special Issue: Loading on Structures*, 41, 1–14.
- Mittal, H., Sharma, A., & Gairola, A. (2018). A review on the study of urban wind at the pedestrian level around buildings. *Journal of Building Engineering*, 18, 154-163.
- Mochida, A., & Lun, I.Y.F. (2008). Prediction of wind environment and thermal comfort at pedestrian level in urban area. *Journal of Wind Engineering and Industrial Aerodynamics*, 96(10–11), 1498-1527.
- Moreno, J. (1989). *Analysis and Design of High-Rise Concrete Buildings*, ACI SP-97 Series, Michigan: American Concrete Institute.
- Parker, D., & Wood, A. (2013). *The Tall Buildings Reference Book*. First published, Routledge, Taylor & Francis Group, USA.
- Potter, M.C., Wiggert, D.C., & Ramadan, B.H. (2011). *Mechanics of Fluids*, (Fourth edition. ed.), Thomson Wadsworth publisher, 105.
- Rott, N. (1990). Note on the history of the Reynolds number. *Annual Review of Fluid Mechanics*, 22 (1), 1–11.
- Shiqing, H. Xuhui, H. & Hua, H. (2017). Characteristics of the aerodynamic interference between two high-rise buildings of different height and identical square cross-section. *Wind and Structures*, 24(5), 501-528.
- Stathopoulos, T. (2009, July). Wind and comfort. In 5th European and African Conference on Wind Engineering, EACWE 5, Proceedings.
- Sullivan, P.P. McWilliams, J.C. & Moeng, C.H. (1994). A subgrid-scale model for large-eddy simulation of planetary boundary-layer flows. *Boundary-Layer Meteorology*, 71(3), 247–276.
- Tamura, T. & Miyagi, T. (1999). The effect of turbulence on aerodynamic forces on a square cylinder with various corner shapes.

*Journal of Wind Engineering and Industrial Aerodynamics*, 83(1-3), 135-145.

Tamura, T. Miyagi, T. & Kitagishi, T. (1998). Numerical prediction of unsteady pressures on a square cylinder with various corner shapes. *Journal of Wind Engineering and Industrial Aerodynamics*. 74(76), 531-542.

Tanaka, H. Tamura, Y. Ohtake, K. Nakai, M. & Kim, Y.C. (2012). Experimental investigation of aerodynamic forces and wind pressures acting on tall buildings with various unconventional configurations. *Journal of Wind Engineering and Industrial Aerodynamic*, 107(108), 179-191.

Tominaga, Y. Mochida, A. Yoshie, R. Kataoka, H. Nozu, T. Yoshikawa, M. & Shirasawa, T. (2008). AIJ guidelines for practical applications of CFD to pedestrian wind environment around buildings. *Journal of Wind Engineering and Industrial Aerodynamics*, 96 (10-11), 1749-1761.

Wahrhaftig, D.M.A., & Da Silva, M.A. (2018). Using computational fluid dynamics to improve the drag coefficient estimates for tall buildings under wind loading. *The Structural Design of Tall and Special Buildings*, 27, e1442.

Hall, N. (2015). *What is drag?* Retrieved from: [www.grc.nasa.gov/www/k-12/airplane/drag1.html](http://www.grc.nasa.gov/www/k-12/airplane/drag1.html)

Xie, J. (2012). Aerodynamic optimization in super-tall building designs. *7th International Colloquium on Bluff Body Aerodynamics and its Applications (BBAA7)*. Shanghai, China; September: 2-6.

Xie, J., (2014). Aerodynamic optimization of super-tall buildings and its effectiveness assessment. *Journal of Wind Engineering and Industrial Aerodynamics*, 130, 88-98.

Xu, Z., & Xie, J. (2015). Assessment of across-wind responses for aerodynamic optimization of tall buildings. *Wind and Structures*, 21(5), 505-521.

Yasa, E. (2016). Computational evaluation of building physics—The effect of building form and settled area", microclimate on pedestrian level comfort around buildings. *Building Simulation*, 9(4), 489-499.

Zhi, L., Chen, B., & Fang, M. (2015). Wind load estimation of super-tall buildings based on response data. *Structural Engineering & Mechanics*, 56 (4), 625-648.

Zhiyin, Y. (2015). Large-eddy simulation: Past, present, and the future. *Chinese Journal of Aeronautics*, 28(1), 11-24.

Baghaei Daemei, A., Eghbali, S., Moez, H., & Bahrami, P. (2019). Wind tunnel flow simulation and aerodynamic shape optimization of tall buildings to improve the drag coefficient under wind forces. *Hoviatshahr*, 13(2), 63-80.

Lucy Marsland, Khanh Nguyen, Yichi Zhang, Yuemin Huang, Yousef Abu-Zidan, Tharaka Gunawardena, Priyan Mendis, (2022). Improving aerodynamic performance of tall buildings using façade openings at service floors, *Journal of Wind Engineering and Industrial Aerodynamics*, 225, 104997.

Yi Li, Qian Song, Chao Li, Xuan Huang, Yan Zhang, (2022). Reduction of wind loads on rectangular tall buildings with different taper ratios, *Journal of Building Engineering*, 45, 103588.

Lei Zhou, K.T. Tse, Gang Hu, (2022). Experimental investigation on the aerodynamic characteristics of a tall building subjected to twisted wind, *Journal of Wind Engineering and Industrial Aerodynamics*, 224, 104976.

