



A Fuzzy Controlled PWM Current Source Inverter for Wind Energy Conversion System

Mehrnaz Fardamiri¹, Shahram Javadi², Seyed Zeinolabedin Moussavi³,

¹ Electrical Engineering Department, Central Tehran Branch, Islamic Azad University, m.fardamiri@yahoo.com

² Assistant Professor, Central Tehran Branch, Islamic Azad University, sh.javadi@iauctb.ac.ir

³ Faculty of Electrical and Computer Engineering Shahid Rajaei Teacher Training university, Tehran, Iran, SMoussavi@Srtt.edu

Abstract

In this paper, a fuzzy controller is proposed to control the current source inverter (CSI) in a wind energy conversion system (WECS) based on permanent magnet synchronous generator (PMSG). The fuzzy controller guarantees the unity power factor operation of CSI. In order to drive CSI the space vector switching (SVM) is utilized. In addition, the WECS has a buck converter which regulates the DC current so that the maximum power point tracking is achieved. The proposed system is implemented in MATLAB/SIMULINK, and the results are provided and compared with the traditional PI controller based systems. The results show that the proposed system is faster than traditional PI controller based systems.

Keywords: Fuzzy Controller, Current Source Inverter, PMSG, WECS.

© 2014 IAUCTB- IJSEE Science. All rights reserved

1. Introduction

In recent years, there has been a fast growth in wind energy conversion system (WECS). There are two general types of wind turbines in WECS: fixed speed wind turbines and varying speed wind turbines [1]. Permanent magnet synchronous generator (PMSG) is one of the most attractive generators for the varying speed turbine WECS. The high efficiency and elimination of the gear box, are two advantages of these electrical machines which has attracted the attention of many researchers. Voltage source inverter (VSI) is the most conventional topology for WECS. However, current source inverter (CSI) topology has been recently became a good alternative for VSI. Some of the attracting features of CSI are high power density, simple control schemes (compared to VSI) and low harmonic output voltage waveform [2].

There are some topologies for CSI used in WECS. In [3] the authors proposed a topology which uses a PWM current source rectifier (CSR) and PWM current source inverter (CSI). This topology has a better control performance but is some expensive case. Another topology which uses a diode rectifier and thyristor inverter is proposed in [4]. In this case the reliability is increased and the cost is decreased. However, the lack of reactive power control and poor grid waveforms make it a less proper choice for modern WECS.

In [5] the authors proposed a topology composed of a full scale PWM CSI with a diode rectifier and a buck converter. In this configuration, both the active and reactive powers that are transferred to the network could be controlled. The traditional PI controllers are used for MPPT and unity power factor operation. However, the controller responses are some slow and the control signals are very turbulent

due to system non-linearity and malfunctioning of traditional PI controllers.

In this paper, a fuzzy controller is proposed to control CSI in a WECS with PMSG. The fuzzy controller guarantees the unity power factor operation of CSI and has a fast response to the

system perturbations. In order to drive CSI the space vector switching (SVM) is utilized. The proposed system is implemented in MATLAB/SIMULINK, and the results are provided and compared with the traditional PI controller based systems.

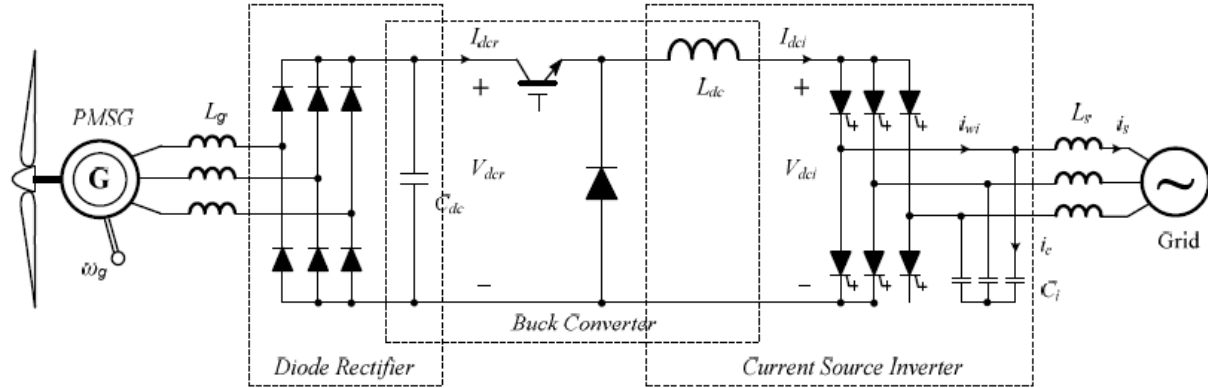

Fig. 1. PWM CSI assisted with diode rectifier and buck converter for WECS

2. DC Current Analysis

Generally, in WECS, the flow of power is unidirectional. This means that the power always flows from the wind turbine to the grid. Diode rectifiers are reliable and inexpensive devices that could be used as generator side converters in order to transfer the AC power to DC power. Fig.1 shows the configuration a PWM CSI and a diode rectifier that are employed in a PMSG-based WECS. As it is illustrated in Fig. 1, the PWM CSI is directly connected to the network. In order to have successful converter current commutation, the capacitor bank C_i must be connected to the AC side. However, this capacitor bank consumes a lot of reactive power. To have the power factor (PF) requirement satisfied at the point of grid connection, this reactive power consumption must be compensated by the converter.

The voltage oriented synchronous frame is used for analyzing and developing the control scheme of the grid side inverter. Consequently, the grid voltage has a component only on the d-axis of the synchronous frame. Also, it is assumed that the voltage of capacitor bank v_c is equal to the grid voltage v_s . The reason for this lies in the relatively small grid side equivalent inductance L_s .

According to the current directions defined in Fig. 1, i_{wi} is equal to the sum of two other current i_c , and i_s . When the power factor is equal to zero, the grid current has only the active component i_{sd} . Therefore, the converter has to fully compensate the capacitor current. But, when the grid requires a leading power factor, it increases the reactive

current component of the converter current, and as a result i_{wi} also increases. Operating under a power factor of unity can be considered as special case lagging power factor operation. The following equations can be used to derive the currents shown in Fig. 2 (a) and (b):

$$i_{sd} = \frac{P_g}{3v_s} \quad (1)$$

$$i_c = 2\pi f_s C_i v_c \quad (2)$$

$$i_s = \frac{i_{sd}}{\cos\varphi} = \frac{i_{sd}}{PF} \quad (3)$$

In equations above, f_s , φ , and $\cos\varphi$ represent the frequency of the grid voltage, the phase difference between i_{sd} and i_s , and the power factor, respectively. According to the phase diagram, i_{wi} can be calculated by using the following equation:

$$i_{wi} = \sqrt{\left(\frac{i_{sd}}{PF}\right)^2 + i_c^2 - \frac{2i_{sd}i_c}{PF} \cos(90^\circ - \cos^{-1} PF)} \quad (4)$$

There is a correlation between the DC current I_{dci} required by the PWM CSI and i_{wi} and the index of modulation m_i which is shown in (5). Normally, the modulation index, m_i , varies between zero and one. It is clear that for a given i_{wi} , I_{dci} is maximum if m_i is equal to unity.

$$I_{dci} = \frac{i_{wi}}{m_i} \quad (5)$$

The above equations show that a minimum DC current level is required for the appropriate

operation of the active and reactive power controls. The level of this DC current also depends on the value of C_i which is typically within the range of 0.3 to 0.6 for drives of medium voltage [1].

3. Proposed Control Scheme

The PWM CSI and the buck converter use the same DC link inductor L_{dc} , whereas its filter capacitor C_{dc} is responsible for smoothing out the output of the diode rectifier. To obtain the desired dc current level for the grid operation, the converter amplifies the diode rectifier output current which has relatively low values.

In the grid voltage oriented synchronous frame, the q-axis component of the grid voltage, v_{sq} , becomes equal to zero; therefore, the magnitude of the grid voltage becomes equal to its d-axis component, v_{sd} . Following equations can be used to calculate the active and reactive powers of the grid:

$$P = 1.5(v_{sd}i_{sd} + v_{sq}i_{sq}) = 1.5v_{sd}i_{sd} \quad (6)$$

$$Q = 1.5(v_{sq}i_{sd} - v_{sd}i_{sq}) = -1.5v_{sd}i_{sq} \quad (7)$$

The power requirements of the grid determine the DC current reference. Using equations (6) and (7), the active and reactive power references can be converted into grid d- and q-axis current references. The current references of the converter are provided by the sum of the calculated capacitor current and grid reference currents. Assuming that modulation index, m_i , is kept at its maximum value which is equal to unity, then the reference current can be derived using (4).

Fuzzy control provides a formal methodology for representing, manipulating, and implementing a human's heuristic knowledge about how to control a system. In this paper we uses a fuzzy logic based controller in order to control the grid side converter. The active power output control is responsible for regulating the DC current therefore. The fuzzy controller provides the reference for adjusting the active current of the grid, i_{sd} . The fuzzy rules are given in Table 1. The membership function for inputs and outputs of fuzzy controller is shown in Fig. 2. According to this membership functions and the fuzzy rules, the surface view of the fuzzy controller is shown in Fig 3. As can be seen in this figure the input errors and the output signal is related using a fuzzy relationship.

The grid side converter controller is shown in Fig 4. The given reactive power reference is used to calculate the reactive current reference of the grid. Finally, using the reference converter currents which are the total of reference grid currents and capacitor currents, the converter modulation index, m_i , and delay angle for SVM gating generation are calculated.

Table.1.
Fuzzy rules for fuzzy controller.

e \ ce	NB	NM	NS	ZZ	PS	PM	PB
NB	NB	NB	NB	NB	NM	NS	ZZ
NM	NB	NB	NB	NM	NS	ZZ	PS
NS	NB	NB	NM	NS	ZZ	PS	PM
ZZ	NB	NM	NS	ZZ	PS	PM	PB
PS	NM	NS	ZZ	PS	PM	PB	PB
PM	NS	ZZ	PS	PM	PB	PB	PB
PB	ZZ	PS	PM	PB	PB	PB	PB

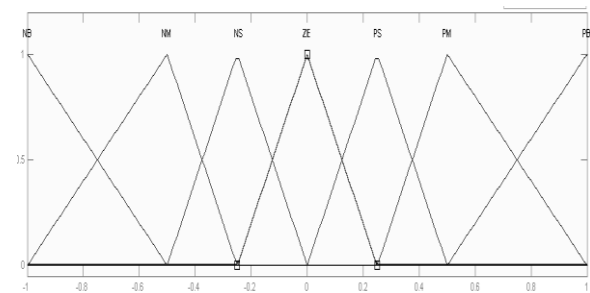

Fig.2. Membership function for inputs and outputs of fuzzy controller.

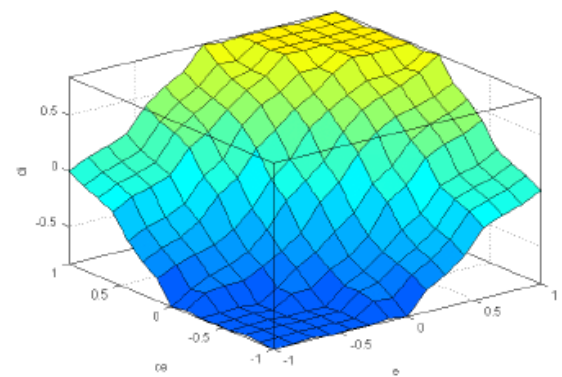

Fig.3. The surface view of the fuzzy controller

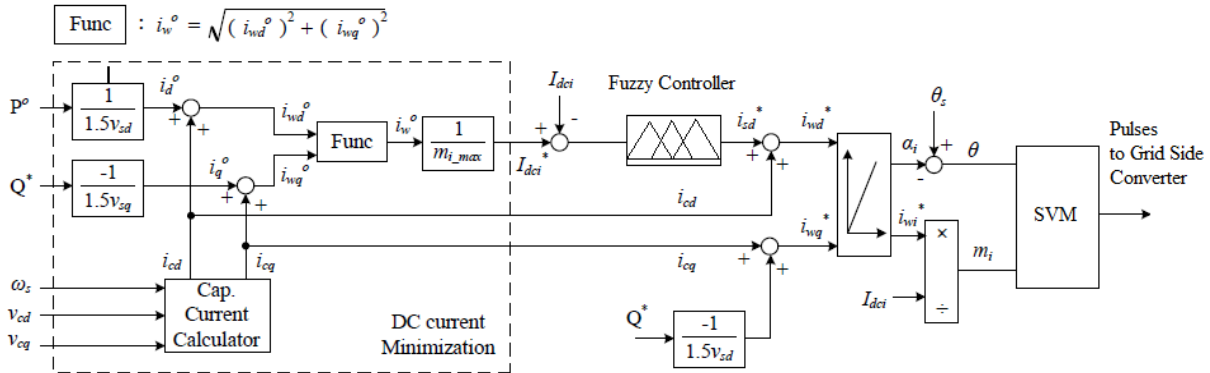

Fig.4. The grid side converter controller

The input and out power of the buck converter is expressed by the following equation [5]:

$$I_{dci} = \frac{I_{dcr}}{D} \tag{13}$$

In the equation above, D represents the duty cycle of the buck converter. Since the grid voltage has stiff characteristic, the DC current loop of the PWM CSI is designed in such a way that it is much faster than the generator speed control loop. Therefore, in the design of the control loop for the buck converter, it could be assumed that I_{dci} is constant. Therefore, DC current level at the diode rectifier side is directly adjusted by tuning the duty cycle. This causes the operating torque and speed of the generator to change. Fig 5 shows buck converter controller, where the MPPT block determines the optimal reference speed of PMSG which maximizes the output power.

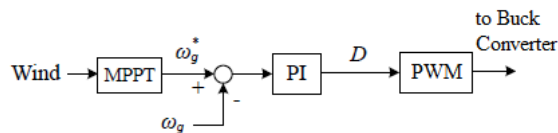

Fig.5. Buck converter controller.

4. Simulation Results

The Matlab / Simulink environment has been used to simulate the proposed system and control scheme. Table 2 shows the system parameters. Both transient responses and steady state operations of the entire system under different wind speeds are considered in the simulation. The proper reactive power control is also verified under different power factor reference, 0.95 lagging and 0.95 leading, and unity.

Detailed profiles of PF reference, reactive power reference, and wind speed that is used in simulation are provided in Table 3. When inductive reactive power is injected into the grid by the PWM

CSI, a positive value is assumed for the reactive power.

Fig.6 and Fig.7 show the waveform of simulation. When a step change from half (6 m/s) to the nominal value (12 m/s) occurs in wind speeds at $t=1$ seconds, as it is shown in Fig.6 (a) and (c), the duty cycle of the buck converter accordingly adjusts the rotational speed of the PMSG. The rotor speed properly follows the reference in steady state. This means that the maximum power is achieved at the corresponding wind speed. Fig.6 (b) displays the generated active power which is related to the wind speed change i.e. 0.25 MW at 6m/s and 1.5 MW at the nominal wind speed. Also, the DC link current displayed in Fig.6 (e) change accordingly to accommodate the variations in active/reactive powers. The modulation index of the PWM CSI being kept close to unity (Fig.6 (d)) indicates that under all operating conditions, the current of the DC link is kept fixed at its minimum level in steady state.

The simulation results of another test are give in Fig.7. The reactive power reference and wind speed change according to Table.3. Fig.7 (a) shows the active and reactive power of CSI. As can be seen from this figure the active power output increases with the wind speed step change and the reactive power properly follows the references given in Table.2. Fig.7 (b) and 7 (c) show the Dc link current and the duty cycle of the buck converter, respectively. These two values change depend on the wind speed and the reactive power reference. Fig.7 (d) shows the grid voltage and current in the duration 2.4 to 2.6 (sec) in which the reactive power reference changes from +0.5 MW to -0.5 MW. At first the current is leading to the voltage (positive reactive power reference) and at second the current is lagging to the voltage (negative reactive power reference).

Table.2.
System parameters used in the simulation.

Generator parameters (Rated, pu based on generator side)		
Apparent Power	2 MVA	1 pu
Stator phase voltage	1732 V (rms)	1 pu
Stator current	513 A (rms)	1 pu
Frequency	11 Hz	1 pu
Power factor	0.75	1 pu
Pole pairs	30	1 pu
Magnetic flux linkage	37.7 Wb (rms)	1 pu
L_d, L_q	19.4 mH	0.398 pu
DC link parameters (pu based on generator side)		
C_{dc}	2100 μ F	1 pu
L_{dc}	48.8 mH	1 pu
Grid side parameters (Rated, pu based on grid side)		
Apparent Power	1.5 MVA	
Phase voltage	1732 V (rms)	1 pu
Line current	405 A (rms)	1 pu
Power factor	0.95	
Frequency	60 Hz	1 pu
L_s	1.08 mH	0.12 pu
C_i	471 μ F	0.6 pu

Table.3.
Wind speed, PF and reactive power references

Time Duration (s)	0-0.5	0.5-1	1-1.5	1.5-2	2-2.5	2.5-3
Wind Speed (m/s)	6			12		
Q_{ref} (MW)	0.5	-0.5	0	0	0.5	-0.5

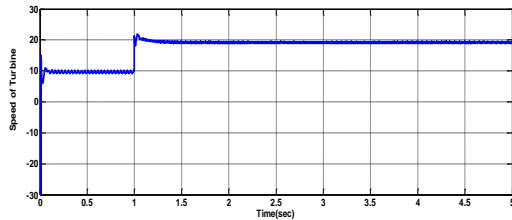

(a) Wind turbine and rotor speed

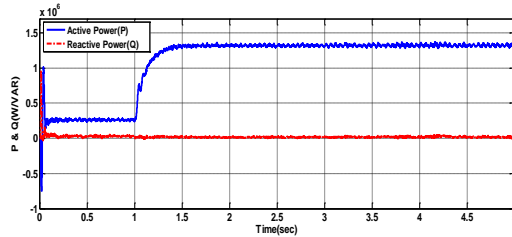

(b) Grid active and reactive powers

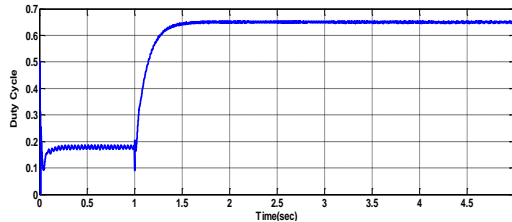

(c) Duty cycle of the buck converter

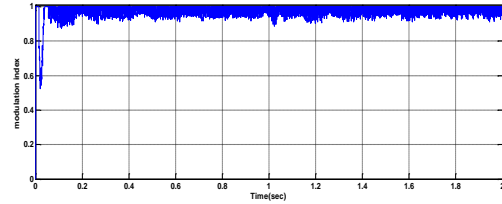

(d) Modulation index of the PWM CSI

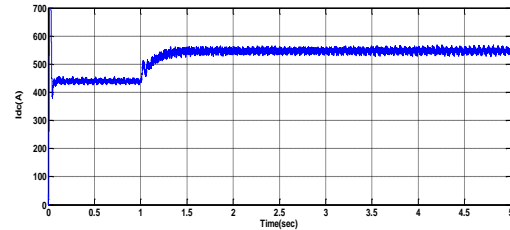

(e) The DC link current

Fig.6. Simulation waveforms under various wind speeds and power factor requirements.

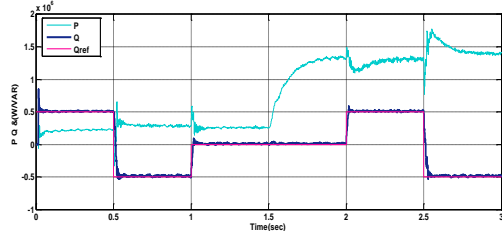

(a) Grid active and reactive powers

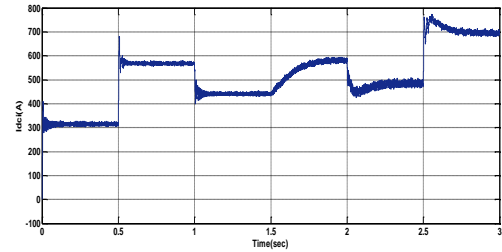

(b) The DC link current

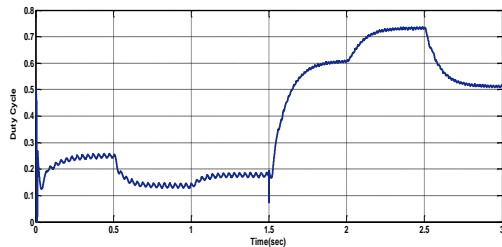

(c) Duty cycle of the buck converter

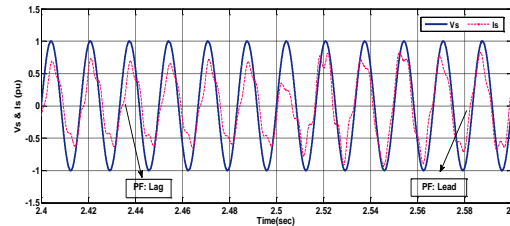

(d) Grid voltage and current waveforms at 12m/s

Fig.7. Simulation waveforms of grid voltage and current under various wind speeds and power factor requirements

5. Conclusion

In this paper, a fuzzy control scheme is developed for PMGS-based WECS configuration so that it can achieve maximum power tracking from the fluctuating wind and grid power factor control requirements (unity, leading or lagging). Moreover, in order to decrease the total power loss, the operating DC current in the PWM CSI is minimized. Simulation results revealed that the proposed configuration and control scheme has an appropriate performance.

References

- [1] W. W. E. Association, "World Wind Energy Report 2008," *WWEA, Bonn*, 2009.
- [2] B. Wu, "High-power Converters and AC Drives", John Wiley & Sons, 2006.
- [3] J.Nasiri, "Feasibility of Biogas Plant in Saveh City", www.SID.ir, 2008 .
- [4] J. Dai, D. Xu, and B. Wu, "A Novel Control System for Current Source Converter Based Variable Speed PM Wind Power Generators", *Power Electronics Specialists Conference, PESC, IEEE*, pp.1852-1857, 2007.
- [5] X. Tan, J. Dai, and B. Wu, "A Novel Converter Configuration for Wind Applications Using PWM CSI with Diode Rectifier and Buck Converter", *IEEE Electric Machines & Drives Conference (IEMDC)*, pp.359-364, 2011.