

Biography



Mohamad Reza Moradian was born in Isfahan, Iran in 1975. He received the B.S. and M.S. degrees in electrical engineering from Isfahan University of Technology, Iran, in 1998 and 2000, respectively. Since 2001, he has been a faculty member of electrical engineering department in Islamic Azad University, Najafabad branch. He has been managing power engineering group since 2006. His research interests are in the areas of modeling and control of ac motors and power electronic.



Khalil Rahimi was born in Isfahan, Iran, in 1980. He received the B.Sc. and M.Sc. in electrical engineering from Malek-Ashtar University of Technology, Iran in 2004 and from Isfahan University of Technology, Iran in 2007, respectively. Since 2007, he has been with the Power Electronics R & D Division, Information and Communication Technology Institute (ICTI), Isfahan University of Technology, as a researcher. His research interests include power electronics, electrical machines, and drives.



Majid Pakdel received the B.S. degree in electrical engineering from the Amirkabir University of Technology, Tehran, Iran in 2004 and the M.S. degree in power systems from the Isfahan University of Technology, Isfahan, Iran, in 2006. His research interests include power electronics and electric machines drives, power converters controls, finite element, soft switching and active power filters. He has authored around 6 published technical articles in the relevant areas.

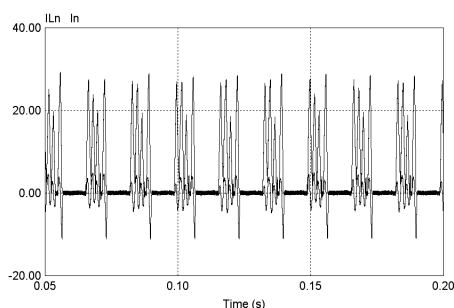

Fig. (17): Load and source neutral currents in case II.

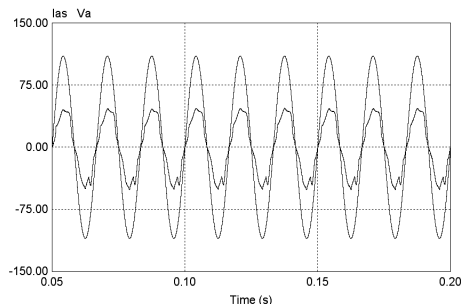

Fig. (18): Source voltage and current of phase a in case II.

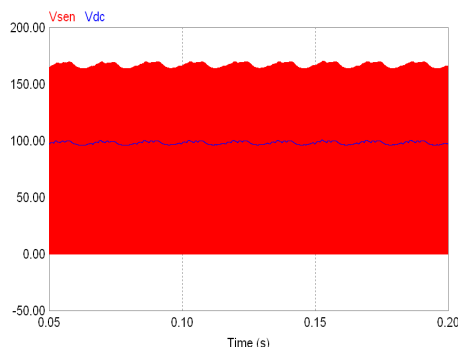

Fig. (19): DC capacitor and resonant dc link voltage in case II.

As shown in Fig. 8 to Fig. 19, the designed active power filter is very effective in load balancing and power factor correction purposes. This active power filter can successfully compensate the harmonic currents of the rectifier with capacitive or inductive loads. The designed active power filter can also compensate the harmonic currents of other non-linear loads. Furthermore, since the switching of power switches is done under ZVS conditions, the loss is reduced in the active filter. Therefore, the application of soft-switching techniques causes high efficiency and power density in active power filters.

V. Conclusion

In this paper, a new soft-switched topology for losses reduction in a three-phase four-wire shunt active power filter is proposed. The soft-switching technique not only offers a reduction in switching loss and thermal requirement, but also allows the possibility of high frequency and snubberless operation. Improved circuit performance and efficiency as well as reduction of EMI emission can be achieved. Soft-switched active power filters can be a viable alternative to hard-switched APFs. Since the switching of power switches is done under ZVS conditions, the losses is reduced in the active filter. Therefore, the application of soft-switching techniques causes high efficiency and power density in active power filters. The simulation results with the designed soft-switched SAPF show that the proposed topology and control strategy is very effective in harmonic current compensation of rectifier with capacitive or inductive loads. Also, it can compensate harmonic currents of other non-linear loads. This control method improves the power factor of supply side effectively. The designed soft-switched SAPF and its control strategy can be implemented with lower cost in practice and it has higher efficiency.

References

- [1] D. Shen, P.W. Lehn, "Fixed-frequency space-vector-modulation control for three-phase four-leg active power filters", IEE Proc-Elect. Pow. Appl., Vol.149, No.4, July 2002.
- [2] W. Yong, S. Songhua, C. Yu, "Study on the three-phase four-legs active filter based on one-cycle control", IEEE Proc-ICEMS, Vol.2, pp.1301-1304, Sep. 2005.
- [3] P. Verdelho, G.D. Marques, "Four-wire current-regulated PWM voltage converter", IEEE Trans. Ind. Elect., Vol.45, pp.761-770, 1998.
- [4] T. Thomas, K. Haddad, G. Joos, A. Jaafari, "Performance evaluation of three phase and four wire active filters", Conf. Rec. of the IEEE IAS Ann. Meet., San Diego, CA, USA, pp.1016-1023, 1996.
- [5] C.A. Quinn, N. Mohan, "Active filtering of harmonic currents in three-phase four-wire system with three-phase and single-phase nonlinear loads", Proc. of IEEE APEC92, Boston, Massachusetts, USA, pp.829-836, 1992.
- [6] Y.C. Jung, J.G. Cho, G.H. Cho, "A new zero voltage switching resonant dc-link inverter with low voltage stress", Proc. IEEE Indu. Elec. Conf., pp.308-313, 1991.
- [7] H. Akagi, Y. kanzawa, A. Nabae, "Instantaneous reactive power compensators comprising switching devices without energy components", IEEE Trans. Ind. Appl., IA-20(3), pp.625-630, 1984.

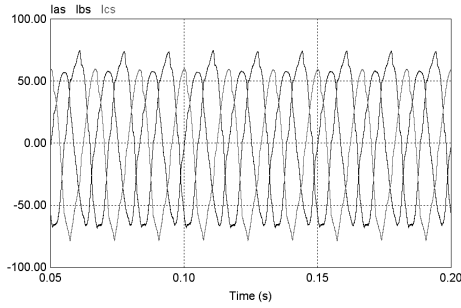

Fig. (9): Source phase currents in case I.

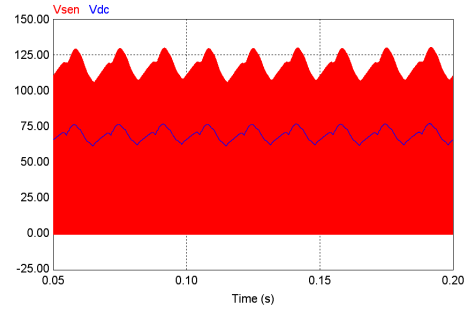

Fig. (13): DC capacitor and resonant dc link voltage in case I.

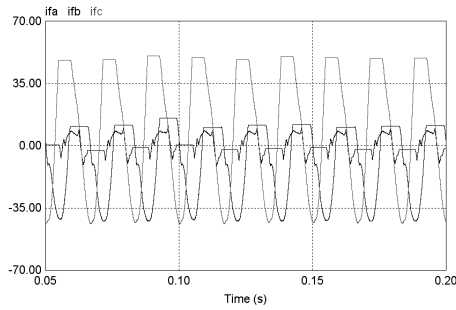

Fig. (10): Filter phase currents in case I.

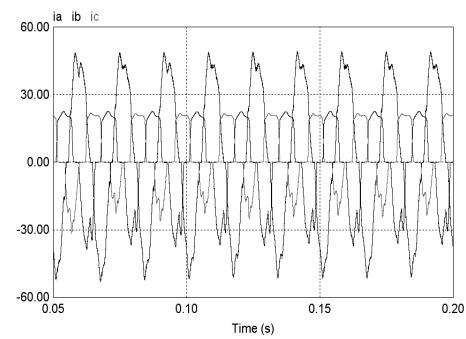

Fig. (14): Load phase currents in case II.

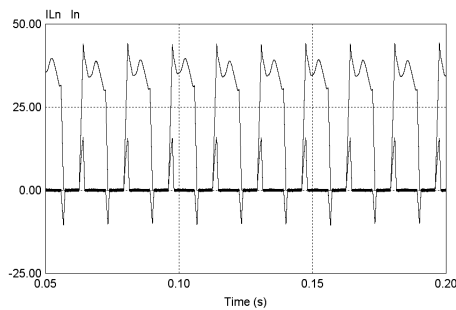

Fig. (11): Load and source neutral currents in case I.

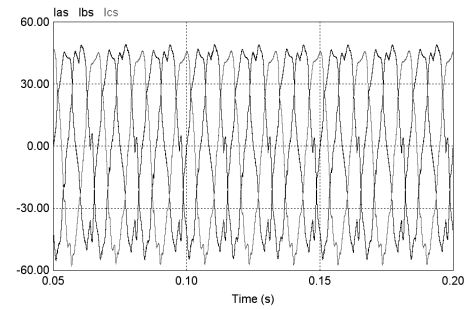

Fig. (15): Source phase currents in case II.

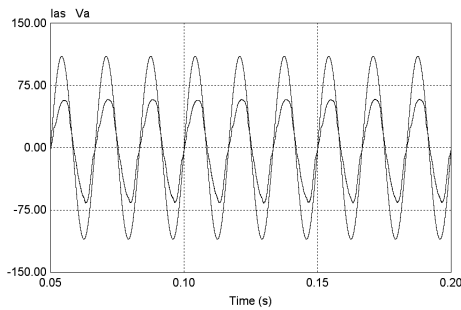

Fig. (12): Source voltage and current of phase a in case I.

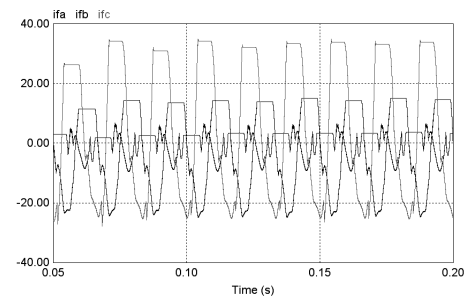

Fig. (16): Filter phase currents in case II.

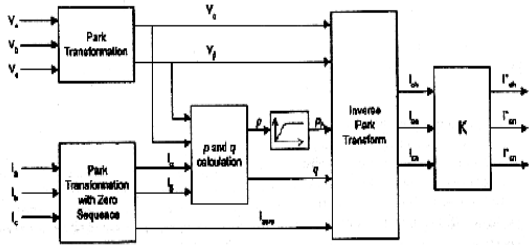

Fig. (4): The block diagram of the current reference generator using p-q theory.

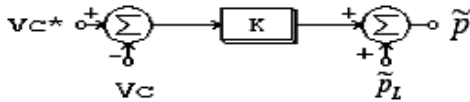

Fig. (5): The block diagram of the dc capacitor voltage control.

The hysteresis control as shown in Fig. 6, is used to control the switching of power devices of the proposed SAPF. In this circuit, the difference between i_{ca} (reference current of phase a) and i_{fa} (active filter output current of phase a) is controlled within hysteresis bands. This topology is repeated in each phase and also in null current compensation.

IV. SIMULATION RESULTS

According to the analysis above, an active power filter is designed and the simulations are performed using PSIM software. The block diagram of the designed system in the workspace of PSIM, is shown in Fig. 7. The operation of the soft-switched active power filter shown in Fig. 7, is performed for rectifiers with different loads. In all cases, the supply voltages are assumed to be a balanced three-phase voltage sources with the magnitude of 110V. The values of L_r, C_r are selected $1\mu F, 10\mu F$ respectively. The values of C_{dc}^*, C_{dc} , output inductor L and L_{dc} are chosen $4.7mF, 2.2mF, 2mH$ and $10\mu H$ respectively. The value of v_c^* (the desired value of the capacitor dc voltage), is selected 70V. The following cases have been simulated:

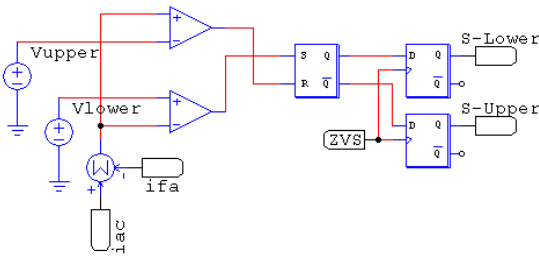

Fig. (6): Hysteresis control of power devices

Case I:
The three-phase rectifier load is

- Series R-L with the values of $R=5\ \Omega, L=5mH$. The single-phase rectifier load is
 - Series R-L with the values of $R=1\ \Omega, L=2mH$.
- Case II:
The three-phase rectifier load is
- Series R-L with the values of $R=5\ \Omega, L=5mH$. The single-phase rectifier load is
 - Shunt R-C with the values of $R=4.7\ \Omega, C=0.47mF$.
- The simulation results of each case are given in the following figures (from Fig. 8 to Fig. 19).

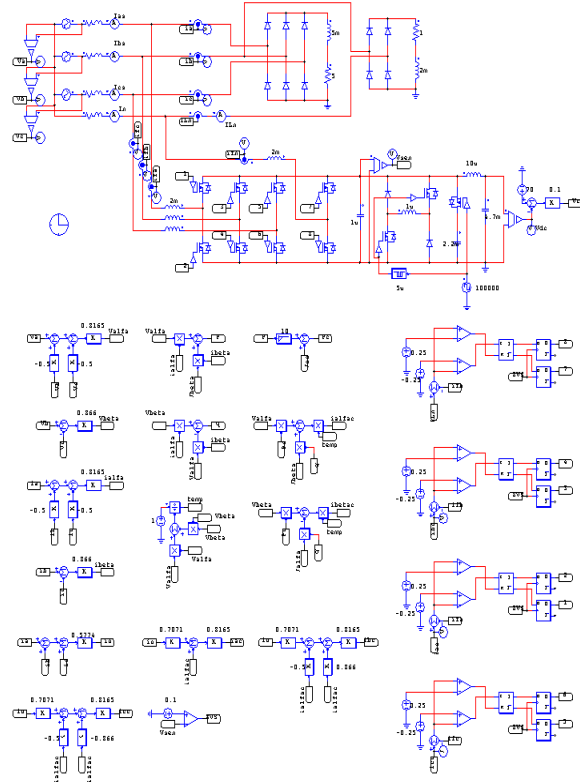

Fig. (7): Block diagram of the designed system, using the PSIM software

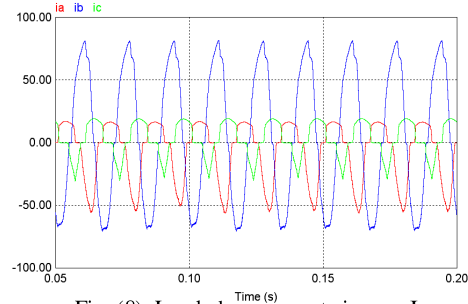

Fig. (8): Load phase currents in case I

This duration is the zero voltage periods created for ZVS of the inverter, and should be longer than the minimum on and off times of the inverter's power switches:

$$\begin{aligned} i_{Lr}(t) &= I_2 \\ v_{cr}(t) &= 0 \end{aligned} \quad (4)$$

(5) Mode 4 (Resonant mode: $(t_3 - t_4)$): This mode begins when T2 and T3 are switched off under ZVS. The second half of the resonance between L_r and C_r starts again. The capacitor voltage $v_{cr}(t)$ increases back from 0 to v_s and is clamped v_s . The relevant equations in this mode are:

$$\begin{aligned} i_{Lr}(t) &= [I_2 - (I_{on} - I_s)] \cos(\omega_r t) - (I_{on} - I_s) \\ v_{cr}(t) &= [I_2 - (I_{on} - I_s)] Z_r \sin(\omega_r t) \\ i_{Lr}(t_4) &= I_3 \\ v_{cr}(t_4) &= V_s \end{aligned} \quad (5)$$

where I_{on} is the load current after the switching state.

(6) Mode 5 (Discharging mode: $t_4 - t_5$): In this period, T1 is switched on under ZV condition because $v_{cr}(t) = V_s$. The inductor current decreases linearly. This mode finishes when $i_{Lr}(t)$ becomes zero.

$$\begin{aligned} i_{Lr}(t) &= -\frac{V_s}{L_r} t + I_3 \\ v_{cr}(t) &= V_s \\ i_{Lr}(t_5) &= 0 \end{aligned} \quad (6)$$

III. CONTROL STRATEGY

One alternative to determine the current reference required by the voltage-source inverter is the use of the instantaneous reactive power theory, proposed by Akagi [5]. This concept is very popular and useful for this type of application, and basically consists of a variable transformation from the a, b, c reference frame of the instantaneous power, voltage and current signals to the α, β reference frame. The instantaneous values of voltages and currents in the α, β coordinates can be obtained from the following equations:

$$\begin{bmatrix} v_\alpha \\ v_\beta \end{bmatrix} = [A] \begin{bmatrix} v_a \\ v_b \\ v_c \end{bmatrix}, \quad \begin{bmatrix} i_\alpha \\ i_\beta \end{bmatrix} = [A] \begin{bmatrix} i_a \\ i_b \\ i_c \end{bmatrix} \quad (7)$$

where A is the transformation matrix and is equal to:

$$[A] = \sqrt{\frac{2}{3}} \begin{bmatrix} 1 & -1/2 & -1/2 \\ 0 & \sqrt{3}/2 & -\sqrt{3}/2 \end{bmatrix} \quad (8)$$

This transformation is valid if and only if $v_a(t) + v_b(t) + v_c(t)$ is equal to zero and also if the voltages are balanced and sinusoidal. The instantaneous active and reactive power in the α - β coordinates are calculated with the following expressions:

$$p(t) = v_\alpha(t) i_\alpha(t) + v_\beta(t) i_\beta(t) \quad (9)$$

$$q(t) = -v_\alpha(t) i_\beta(t) + v_\beta(t) i_\alpha(t) \quad (10)$$

From Eqs. (9) and (10) the values of p and q can be expressed in terms of the dc components plus the ac

Since this system is a three-phase four-wire circuit with

components, that is:

$$p = \bar{p} + \tilde{p} \quad (11)$$

$$q = \bar{q} + \tilde{q} \quad (12)$$

where:

\bar{p} : is the dc component of the instantaneous power p , and is related to the conventional fundamental active current.

\tilde{p} : is the ac component of the instantaneous power p , it does not have average value, and is related to the harmonic currents caused by the ac component of the instantaneous real power.

\bar{q} : is the dc component of the imaginary instantaneous power q , and is related to the reactive power generated by the fundamental components of voltages and currents.

\tilde{q} : is the ac component of the instantaneous imaginary power q , and is related to the harmonic currents caused by the ac component of instantaneous reactive power.

In order to compensate reactive power and current harmonics generated by nonlinear loads, the reference signal of the shunt active power filter must include the values of \tilde{p} , \bar{q} , and \tilde{q} . In this case the reference currents required by the SAPF are calculated with the following expression:

$$\begin{bmatrix} i_{c\alpha}^* \\ i_{c\beta}^* \end{bmatrix} = \frac{1}{v_\alpha^2 + v_\beta^2} \begin{bmatrix} v_\alpha & v_\beta \\ v_\beta & -v_\alpha \end{bmatrix} \begin{bmatrix} \tilde{p}_L \\ \bar{q}_L + \tilde{q}_L \end{bmatrix} \quad (13)$$

The final compensating currents including the zero sequence components in a, b, c reference frame are the following:

$$\begin{bmatrix} i_{ca}^* \\ i_{cb}^* \\ i_{cc}^* \end{bmatrix} = \sqrt{\frac{2}{3}} \begin{bmatrix} \frac{1}{\sqrt{2}} & 1 & 0 \\ \frac{1}{\sqrt{2}} & -\frac{1}{2} & \frac{\sqrt{3}}{2} \\ \frac{1}{\sqrt{2}} & -\frac{1}{2} & -\frac{\sqrt{3}}{2} \end{bmatrix} \begin{bmatrix} -i_0 \\ i_{c\alpha}^* \\ i_{c\beta}^* \end{bmatrix} \quad (14)$$

where the zero sequence current component i_0 is equal to

$$\frac{1}{\sqrt{3}}(i_a + i_b + i_c).$$

The block diagram of the circuit required to generate the reference currents defined in (14) is shown in Fig. 4. In the former discussion, we assumed that the dc capacitor voltage of the active power filter is constant, which requires the net average active power flowing into the capacitor during one cycle to be zero. However it cannot be automatically guaranteed in the actual circuit. So a voltage feedback control as shown in Fig. 5, is added to regulate the capacitor dc voltage of the SAPF. In this circuit, the actual dc capacitor voltage is detected and compared with the reference value, and the error is amplified then is added to the \tilde{p}_L , the output of high-pass filter in Fig. 4. Therefore, active power flowing into the capacitor will be changed and the dc voltage can be controlled.

nonlinear loads (rectifiers), thus we would have non-

sinusoidal currents, which are unbalanced (i.e. the current amplitudes are not equal). Since the currents are unbalanced, the consequent non-sinusoidal currents are flowing in the neutral wire. Our purpose is to eliminate harmonic currents and to balance the three phase non-sinusoidal currents resulted from non-linear loads, as well as improving supply side power factor. A resonant dc link with low voltage stress and three-phase four-leg active power filter is shown in Fig. 1. The soft-switched SAPF consists of a front-end resonant converter that can pull the dc link voltage down just before any inverter switching.

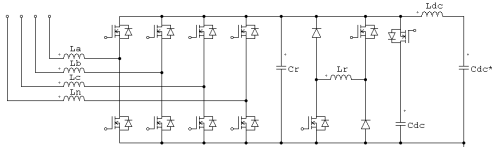

Fig. (1): Power converter of soft-switched SAPF

This resonant dc circuit serves as an interface between the dc capacitor and the SAPF. It offers advantages, including:

1. No increase in the dc link voltage when compared with a conventional hard switched inverter. That is, the dc link voltage is 1.0 per unit.
 2. The zero voltage condition can be created at any time.
 3. Well-established PWM techniques can be employed.
 4. Power devices of standard voltage ratings can be used.
- The timing program and the six operating modes of this resonant circuit are as shown in Fig. 2 and Fig. 3, respectively.

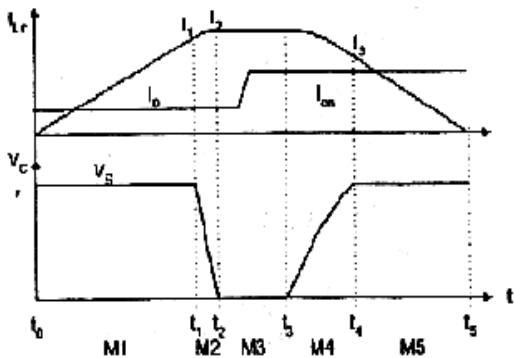

Fig. (2): Timing diagram of a resonant link inverter with minimum voltage stress

(1) Normal mode: This is the standard PWM inverter mode. The resonant inductor current $i_{Lr}(t)$ and the resonant voltage $v_{cr}(t)$ are given by:

$$i_{Lr}(t) = 0 \tag{1}$$

$$v_{cr}(t) = V_s$$

where v_s is the nominal dc link voltage.

(2) Mode 1 (Initiating mode: $(t_0 - t_1)$): At t_0 , mode 1 begins by switching T2 and T3 on with zero current. Then $i_{Lr}(t)$ increases linearly with a di/dt of v_s/L_r .

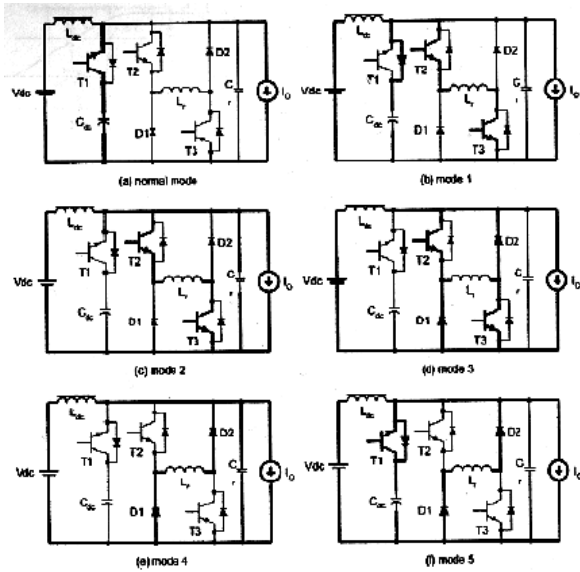

Fig. (3): Operating modes of resonant link inverter with minimum voltage stress.

If $i_{Lr}(t)$ is equal to the initialized current I_i , T1 is zero-voltage turned off. If $(I_s - I_o) < I_i$, Then the initialization is ended when $i_{Lr}(t)$ is equal to I_i , where I_s is the current flowing into the dc inductor L_{dc} . If $(I_s - I_o) > I_i$, then this mode continues until $i_{Lr}(t)$ is equal to $(I_s - I_o)$. The equations in this interval are:

$$i_{Lr}(t) = \frac{V_s}{L_r} t \tag{2}$$

$$v_{cr}(t) = V_s$$

$$i_{Lr}(t_1) = \frac{V_s}{L_r} t_1 = I_i$$

Mode 2 (Resonant mode: $t_1 - t_2$): After T1 is turned off under the ZVS condition, resonance between L_r and C_r occurs. The $v_{cr}(t)$ decreases from V_s to zero. At t_2 , $i_{Lr}(t)$ reaches the peak value in this interval. The equations are:

$$i_{Lr}(t) = \frac{V_s}{Z_r} \sin(\omega_r t) + [I_i + (I_o - I_s)] \cos(\omega_r t) - (I_o - I_s)$$

$$v_{cr}(t) = -V_s \cos(\omega_r t) - [I_i + (I_o - I_s)] Z_r \sin(\omega_r t)$$

$$I_{Lr}(t_2) = I_2 = I_{Lr,peak}$$

$$v_{cr}(t_2) = 0 \tag{3}$$

where

$$Z_r = \sqrt{\frac{L_r}{C_r}}$$

$$\omega_r = \frac{1}{\sqrt{L_r C_r}}$$

(4) Mode 3 (Freewheeling mode: $t_2 - t_3$): The resonant inductor current flows through two freewheeling paths (T2-Lr-D2 and T3-D1-Lr).

A New Soft-Switched Three-Phase Four-Wire Shunt Active Power Filter

Mohammad Reza Moradian - Khalil Rahimi - Majid Pakdel

Instructor of Department of Electrical Engineering - Islamic Azad University - Najafabad Branch

Recive: July 2009

Accept: August 2010

Abstract: This paper presents a new soft switched topology for losses reduction in a three-phase four-wire shunt active power filter (SAPF). The soft-switching technique not only offers a reduction in switching loss and thermal requirement, but also allows the possibility of high frequency and snubberless operation. Improved circuit performance and efficiency as well as reduction of EMI emission can be achieved. The resonant dc link inverter with low voltage stress is used for power converter of a three-phase four-wire shunt active power filter. It is assumed that the active power filter is connected to a load that can be unbalanced and may also draw harmonic currents. The p-q theory is used for controlling the SAPF. The proposed topology and operation principle of the control method is discussed in detail, finally the feasibility of such a scheme is demonstrated through simulation studies.

Index Terms: Soft-switched – active power filter.

I. Introduction

The widespread use of non-linear loads is leading to a variety of undesirable phenomena in the operation of power systems. The harmonic components in current and voltage waveforms are the most important among these. Conventionally, passive filters have been used to eliminate line current harmonics. However, they introduce resonance in the power system and tend to be bulky. With the improved performance of power and control circuits, active power filters have gradually been recognized as a viable alternative to passive filters.

In many commercial and industrial installations, power is distributed through a three-phase four-wire system. This type of system has unique problems. If non-linear single phase loads are present, or the three phase load is unbalanced, line currents are unbalanced and neutral currents flow. These neutral currents contain both fundamental and harmonic components. In extreme cases, the neutral currents are potentially damping to both the neutral conductor and the transformer to which it is connected [1-3]. Three-phase, three-wire active power filters cannot adequately reduce or eliminate line harmonics in this situation [4]. To mitigate these problems, three-phase, four-wire active filters have been proposed. A four-wire active power filter with a four-leg inverter topology is proposed by [5] and that is used in this paper. The soft-switching technique not only offers a reduction in switching loss and thermal requirement, but also allows the possibility of high frequency and snubberless operation. Improved circuit performance and efficiency as well as reduction of EMI emission can be

achieved. For zero voltage switching (ZVS) inverter applications, two major approaches that enable inverters to be soft-switched have been proposed. The first approach pulls the dc link voltage to zero momentarily so that the inverter's switches can be turned on and off with ZVS. The second approach uses the resonant pole idea. By incorporating the filter components in to the inverter operation, resonance condition and thus zero voltage/current conditions can be created for the inverter switches. In this paper the resonant inverter with minimum voltage stress [6] is used, which pulls the dc link voltage to zero momentarily whenever inverter switching is required. The soft switching approach does not cause extra voltage stress to the inverter and hence the voltage rating of the power devices is only 1 per unit. The p-q theory [7] is used for current reference generation in three-phase four-wire systems. A new method is proposed for controlling the dc capacitor voltage and one leg of inverter is used for null current compensation. Because of the use of soft-switched inverter, the inverter loss is reduced. So, its efficiency and power density is very high. Simulation results are given to verify the analysis and demonstrate the control performance.

II. Topology and Operation Principle of Soft-Switched SAPF

It is assumed that a non-linear load consisting of a three-phase diode rectifier and a single phase diode rectifier is connected to three-phase balanced source voltages. Also we consider that the R-L series or R-C shunt loads are connected to the dc side of the rectifiers.