 **DOR: 20.1001.1.27170314.2022.11.3.4.4**

Research Paper

## **Implementation and Simulation of an Automated PLC Hydraulic System for a Double-acting Actuator Using a Proportional Valve**

**Karim Sobbouhi<sup>1</sup>, Farshid Aghadavoudi<sup>1\*</sup>, Mehdi Baharizadeh<sup>2</sup>**

<sup>1</sup>Department of Mechanical Engineering, Khomeinishahr Branch, Islamic Azad University, Khomeinishahr/Isfahan, Iran

<sup>2</sup>Department of Electrical Engineering, Khomeinishahr Branch, Islamic Azad University, Khomeinishahr/Isfahan, Iran

\*Email of Corresponding Author: davoodi@iaukhsh.ac.ir

*Received: August 1, 2022; Accepted: October 22, 2022*

### **Abstract**

The use of electro-hydraulic valves, particularly the proportional valve, has been important progress in the development of modern automated manufacturing equipment such as cutting or forming machine tools. Using these valves, electrical control signals can be converted into fluid energy in hydraulic systems. The main purpose of this study was to implement a control system for a 4-3 proportional hydraulic valve to control the position and speed of a double-acting cylinder. In this paper firstly the equipment is introduced and then the results of the implementation of the closed-loop control of this hydraulic valve controlled by PLC have been presented. The purpose of the control system is to equalize the extending and retraction times of the double-acting hydraulic cylinder. The practical results showed the electro-hydraulic system has performed well and the system has achieved the control goal to an acceptable level. In the simulation section, the performance of an open-loop control electro-hydraulic system for tracking a harmonic voltage input signal has been investigated. The electro-hydraulic circuit was designed in such a way that the stroke time of the hydraulic cylinder is independent of the external load. The results showed that applying input harmonic voltage between -10 and 10 volts causes the cylinder rod to move back and forth under external load.

### **Keywords**

Proportional Valve, Automation, Hydraulic Control, PLC, Linear Actuator

### **1. Introduction**

Today, the development of modern industrial systems is associated with the expansion of automation systems and the combination of control equipment with mechanical equipment. The use of mechatronic equipment has provided new solutions to solve the conflict between productivity and accuracy [1, 2]. The simulation and implementation of these mechanical systems that work by electric and PID controllers have attracted the attention of many researchers [3-5]. Electrohydraulic control systems opened a new horizon in the construction and design of mechanical equipment [4]. Today, these instruments are used in precision instrument systems, hydraulic robotic systems, automation, rolling machines in steel industries, and mobile hydraulics increasingly [6-13]. In these systems, the

advantages of hydraulic equipment, including the large forces and torques, are combined with the advantage of the control systems, which is the accuracy and speed of the reaction. The main advantage of hydraulic systems, compared to pure electric and pneumatic systems is to create a large linear force. But in some cases, hydraulic systems must have precise control and smooth movement even under different loads, including traction and braking loads.

Electrohydraulic types of equipment are used in modern manufacturing systems, especially in cutting machine tools and forming machine tools [1]. In some types of CNCs, such as tripod-structure, controlled electro-hydraulic actuators are used to position the tool or workpiece [1, 2]. Also, in modern hydraulic presses, controlled hydraulic drive equipment is used to adjust speed or force. In metal forming tools, these jacks are used for dynamic crowning systems or deflection compensation in rollers [1]. The basic tool in this equipment is proportional and servo control valves, which are combined with mechatronic and control equipment [8-14]. Controlling the speed and position of hydraulic actuators in different working conditions has been one of the important topics of interest to researchers in this field.

Lee et al. [7] studied the behavior of a proportional valve with internal spool feedback in a paper. In this study, the input signal to the hydraulic valve amplifier was increased and the output flow rate of the hydraulic valve was investigated. According to the obtained results, this type of valve had no output flow in an interval of the input signal, which is called the dead zone. Eliminating this area requires applying a small signal to the proportional valve independent of the main command as I-jump through the amplifier card. In this study, two types of controllers, including PI-D and feed-forward controller, were used to control the valve, and the design of these controllers was done using two methods, the pole placement method and the zero placement method, and the behavior of the system was investigated in the presence of disturbances.

The behavior of a MOOG servo valve to control the speed of a double-rod linear actuator was investigated by Gu et al. [8]. They proposed an output feedback model predictive controller for this electro-hydraulic system. Moreover, an extended state observer is designed to estimate the unmeasured system states. Their experimental results showed that using the designed controller created strong robustness against various model uncertainties.

Dasgupta et al. [10] studied the performance of a proportional directional control valve for controlling a hydrostatic system through simulation and experiment. In this experiment, the performance conditions of a proportional control valve, which has the task of controlling the speed of a hydraulic motor, have been investigated. They proposed a non-linear mathematical model for a hydraulic system using the bond graph method. According to the test results, pressure-flow characteristics of hydraulic valves were obtained. They used this model to the investigation of effective parameters on hydrostatic drive performance. Shi et al. [14] studied an electrohydraulic system with accurate speed and position control independent of load in a mobile hydraulic system. In this article, the main goal has been to increase the accuracy of the speed and position of the arm of a mobile hydraulic machine. In a mobile hydraulic construction, there is a possibility of extreme changes in the applied load on each of the arms. To increase the accuracy and control the movement of the hydraulic actuators of this machine, the control valves are used. In this system after detecting the amount of loading on each actuator, a suitable signal to keep the speed of movement constant is issued through the output of PID controllers for control valves.

So far, few studies have been done on the application of proportional valves to control hydraulic double-acting linear actuators. In some hydraulic systems, the difference between the extending and retracting times of the hydraulic actuator is not desirable. One of the main goals of this study is to implement an electro-hydraulic system that minimizes this difference by controlling the speed of the hydraulic cylinder using the proportional valve. Also, proposing an electro-hydraulic system whose operation is independent of the external load was another goal of this study. This study, using a proportional valve and PLC controller, it has been tried to control the speed and position of the hydraulic linear double-acting actuator. The control parameters are adjusted in such a way that the retracing and extending times of the jack are close to each other. Also, with the use of simulation, a proposed circuit is presented to minimize the effect of external load in pursuit of harmonic input.

## 2. Materials and Methods

In hydraulic systems, the directional valves direct the fluid to the desired paths in the circuit. The spool is the main member of these control valves, which performs sliding movement in the valve chamber with different commands and finally changes the state and behavior of the valve. From the characteristics of the spool, we can refer to its overlap, which determines the ratio of the size of the spool to the valve, in other words, if the spool is larger than the oil passage valve, it is called a spool with positive overlap, and if the spool is the same size, the overlap is zero, and if it is smaller than the hatch, it is called negative overlap.

In classic hydraulic systems, conventional control valves are usually used and have digital and discontinuous behavior. In the case of installation and operation of such equipment, the movement and speed control of linear and rotary actuators is accompanied by impact, shock, and pressure fluctuations because the valves are fully opened or closed in a very short time. As a result, the implementation of a position control system using classical valves is very difficult, expensive, and impractical. In classical electro-hydraulic systems, the induction of electric current to the solenoid is the factor in changing the state and actuation of the valve.

In many cases, including robotic systems, hydraulic systems are used, which require linear actuators to operate under continuous and accurate position and speed control. In such a situation, it is recommended to use hydraulic control valves, including proportional valves. In a proportional valve, the flow rate is a function of the electric current that is applied to the valve by the control circuit. In this category of valves, the speed and position of the operator are controlled simultaneously. For example, a 4-3 proportional control valve can control the speed and position of the load at the same time if the necessary conditions are applied. The classic control valves with digital command are fully opened or closed, but on the other hand, the proportional route control valves with analog command control the oil flow as a percentage. With this function, a throat is formed inside the valve, which controls the flow. In proportional valves, the flow through the valve is a function of the electric current applied to the valve, and this relationship is generally shown below:

$$Q = ik\sqrt{\Delta P} \tag{1}$$

In this equation,  $Q$  is the flow rate of the oil leaving the valve,  $i$  is the electric current entering the valve,  $\Delta P$  is the pressure drop caused by the oil passing through the valve, and  $k$  is a constant representing the behavior of the valve. According to this equation, it is clear that in this type of valve,

the flow through the valve, or in other words the speed of the jack is a function of the electric current entered into the proportional valve. Of course, the presence of non-linear factors such as the dead zone has caused the use of this equipment in practical control systems to be accompanied by difficulties and complications. Also, in these types of valves, the pressure drop is effective on the flow rate of the tank, so the performance of these systems is somehow dependent on the external load on the system, which causes problems for the controller.

To implement the control circuit of speed and position of a hydraulic actuator with high precision, a comprehensive control system including valves and hydraulic actuators and an electrical control circuit are needed. The equipment required to apply the command to the hydraulic valve and the movement of the hydraulic linear actuator in a closed-loop control system is shown in Figure 1. The hydraulic circuit of the proportional valve and PLC controller is shown in Figure 2. The main equipment includes the following:

**Amplifier:** To operate proportional valves, a device is needed to convert the standard signals generated by the controllers into a signal suitable for the proportional valve coil. There are several types of amplifier cards for proportional valves that differ in terms of conditions and installation methods. The selection of each of the above-mentioned types of amplifiers is based on the price, facilities, and conditions of the control circuits, and it is possible to use any of the types of amplifiers to set up a proportional valve. To remove the dead zone, the tolerances of the proportional valve, apart from the main command, the amplifier also applies signals to the solenoid. In this study, a two-channel amplifier is used. In this amplifier, there are several adjustable parameters, which can be called the settings of dead zones, initial current, and the maximum allowable tap current. Terminals W1 are the signal input to the card and terminals A and B are connected to the valve coils. The input of this amplifier is a continuous voltage signal and its output is a current.

**Proportional Valve:** In this research, a Festo 4-3 proportional valve, size 1/8 inch, with the closed center in the mid position has been used.

**Linear position sensor:** To create a closed loop control, it is necessary to take feedback from the position of the double-acting actuator. Generally, rotary encoders are used to identify the position of rotary actuators, and resistance rulers are used for cylinders. In this study, a resistance ruler installed on a linear actuator is used.

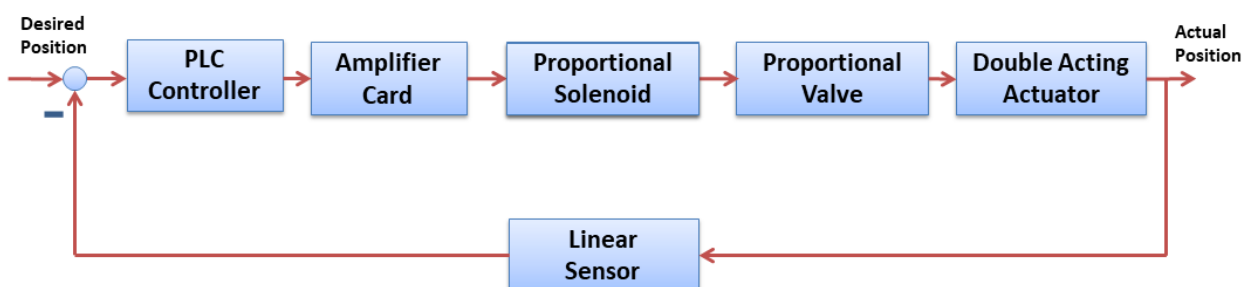

Figure 1. Equipment of closed-loop electro-hydraulic system using proportional valve

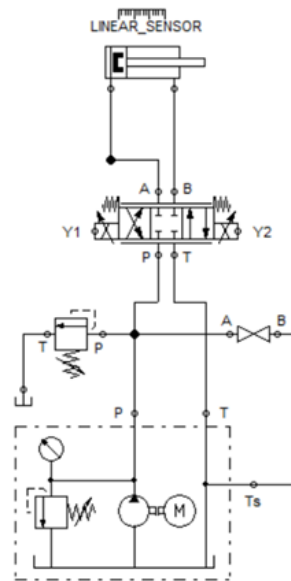

Figure 2. The hydraulic circuit of the proportional valve in closed loop control

According to the possibilities and capabilities of programming in Siemens PLC software, which is called TIA Portal, a program has been written so to keep the extending and retracting times of the double-acting actuator as equal as possible. A linear sensor or linear potentiometer was used to monitor the position of the hydraulic actuator piston and report the position to PLC. According to the received error, the PID controller calculates and sends the necessary electric signal to be applied to the proportional valve. Figure 3 shows the implemented hydraulic circuit. In this system, a two-channel amplifier was used to actuate the proportional valve, whose input signal is defined at the range of -10 to 10 volts and is provided by the PLC analog card. A PID controller block in the programming environment of Siemens PLCs - TIA Portal has been used for the control process.

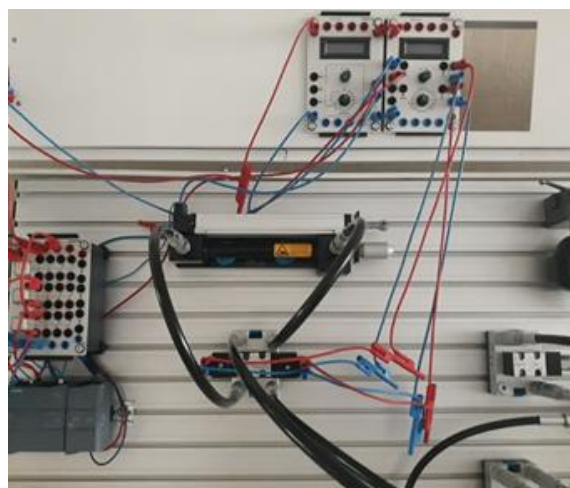

Figure 3. Implemented circuit for closed-loop control of proportional hydraulic valve with PLC

### 3. Results and Discussion

The main goal of the closed-loop control system was implemented with the help of programming. The controller according to the position feedback of the actuator applied a suitable signal to the

proportional valve. Considering that the parameters of the controller affect the performance of the system, the changes in these parameters were studied, and finally, the coefficient P of the controller was determined as 10 in this movement. The value of this parameter was selected by trial and error in such a way as to provide the main goal of the control system, which is to keep the extending and retracting times of the jack equal and prevent instability in the system. It was observed that by increasing the P parameter, the speed of the system increases, or in other words, the slope of the initial signal reaching the desired signal increases, and the sensitivity of the control system increases. Also, as a parameter, I increase, and the error of the steady state decreases. The excessive increase of both values increases the fluctuations and moves the system towards instability.

Figure 4 shows an example of the history of the input and control signals of the proportional valve system in extension and retract strokes. According to this figure, it is clear that the controller has acted in such a way that the retracing and extending of the time of the double-acting cylinder is as similar as possible.

One of the objectives of hydraulic control systems is to track harmonic inputs. This means that in some systems, such as hydraulic robotic systems, the goal is to extend and retract the hydraulic cylinder in such a way that the history of its position tracks a harmonic or sinusoidal input. This function is considered one of the complex control maneuvers for hydraulic systems and it is necessary to analyze the system performance and parameters before implementing the equipment. On the other hand, the performance of hydraulic systems, usually, is a function of the external load applied to the jacks. In this part of the study, a new hydraulic circuit has been proposed to minimize the effect of external load on system performance. As illustrated in Figure 5, this is an improved circuit of the previous hydraulic circuit, which was completed by adding a hydraulic valve called a pressure compensation valve. Then, with the help of hydraulic simulation, the performance of this system in open circuit control for sinusoidal voltage input to the proportional valve has been investigated.

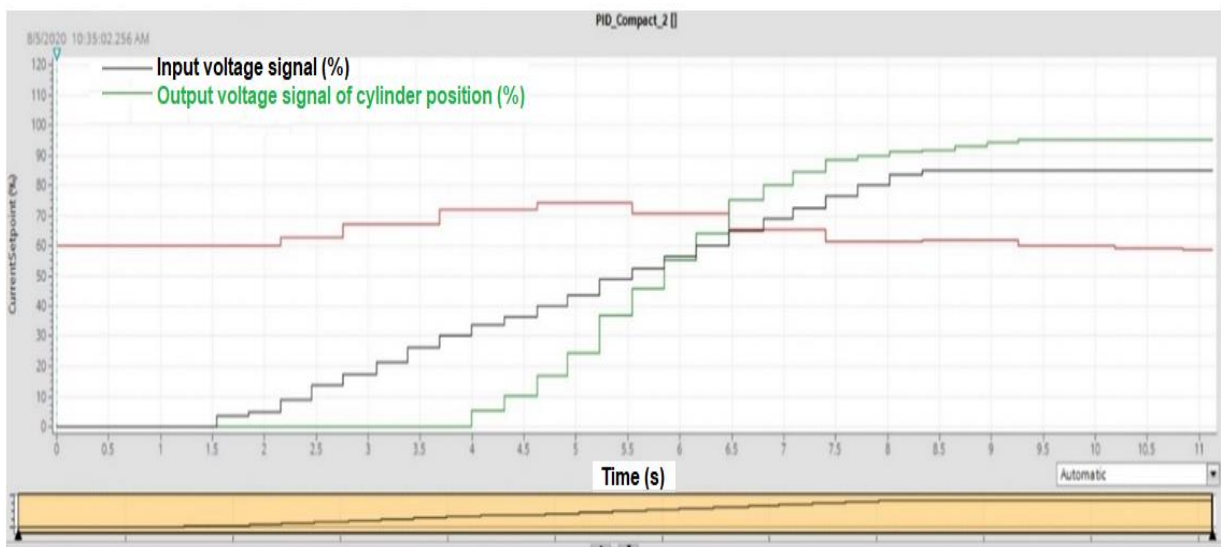

(a)

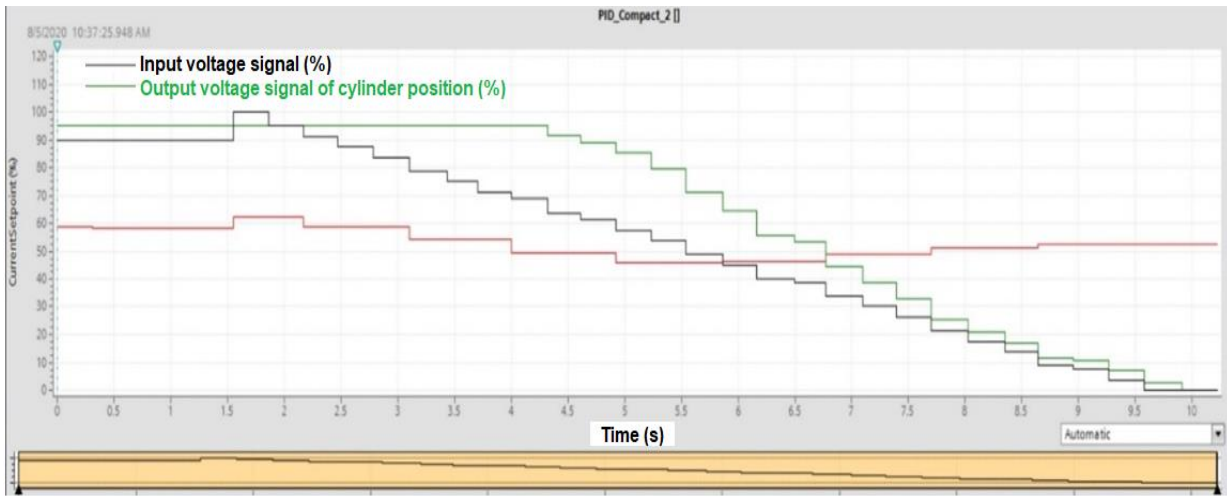

(b)

Figure 4. Time history of the input signal of the proportional valve and the output signal of the hydraulic actuator sensor (a) Extension (b) Retraction

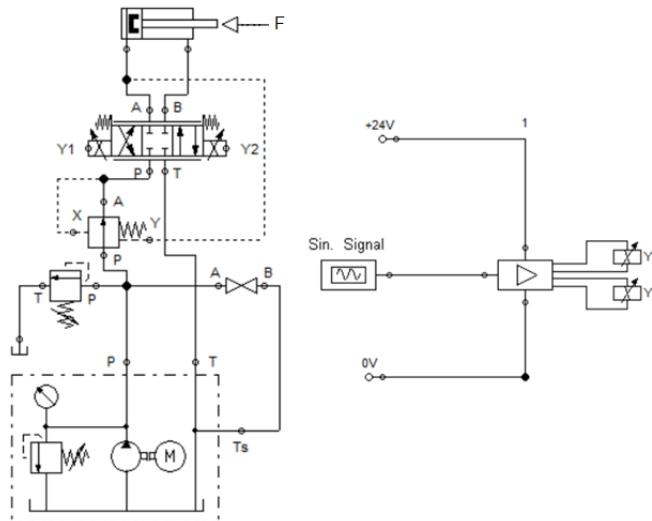

Figure 5. The hydraulic circuit of proportional valve with pressure compensated valve in open loop control actuated by harmonic voltage

As can be seen in Figure 6 by applying a sinusoidal signal, the position of the actuator has almost harmonic behavior. In this case, the amount of voltage applied to the system has been changed harmonically between 10 and -10 volts, and an external force of 500 N was applied to the hydraulic actuator. In this type of sinusoidal signal, the extending and retracing times are slightly different, but the performance of the system in the external load range of 0 to 500 N is almost independent of the external load. For an amplitude of 2 volts input signal and 1000 N load, it was observed that the hydraulic actuator did not have any significant movement. Changing the range or frequency of the control input can cause instability due to the nonlinearity of the control system.

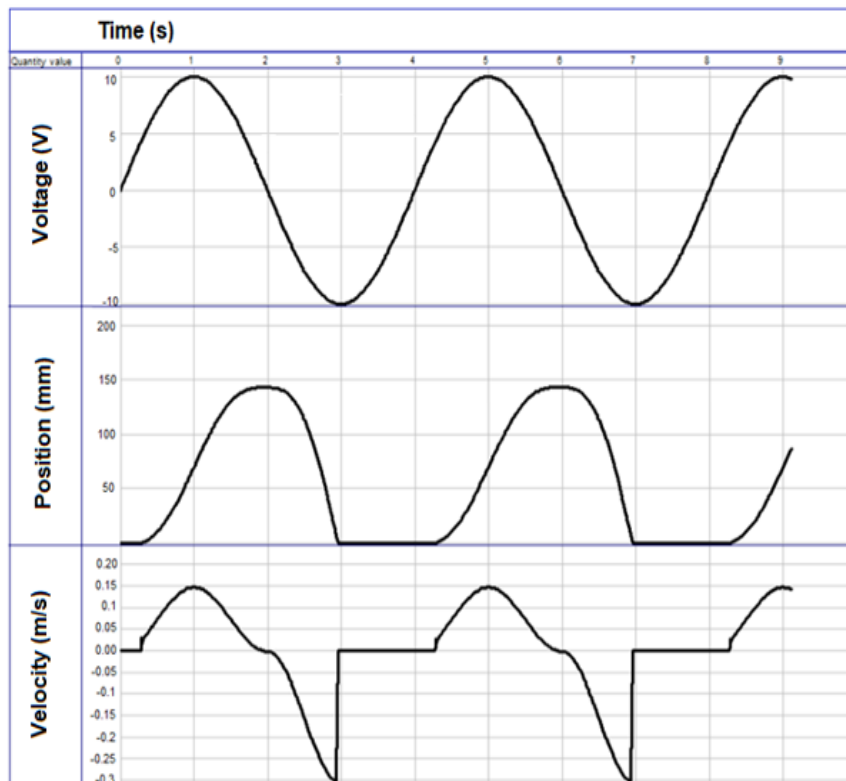

Figure 6. Time history of position and velocity of the hydraulic double-acting cylinder with proportional valve in sinusoidal input voltage tracking

#### 4. Conclusion

In this paper, the implementation of a hydraulic control system using a proportional valve and a PLC controller in a closed-loop control system to control the position of the double-acting hydraulic jack is investigated. Also, tracking of the sinusoidal input for open loop control of an electro-hydraulic circuit with a proportional valve and pressure-compensated valve is studied using simulation software. According to the obtained experimental results, it is clear that by setting the appropriate parameters of the PLC controller, which is done according to the operating conditions, the extending and retracting time of the double acting, can be brought to an equal value. Also, by changing the controller coefficients, the steady-state error can be minimized. Also, this hydraulic control system can track sinusoidal inputs by adjusting the parameters, although the value of these parameters depends on the frequency of the control input and the range of external operating load. It was observed that using the pressure compensation valve in the hydraulic circuit of the system in the range between 0 and 500 N was almost independent of the external load.

#### 5. References

- [1] Neugebauer, R., Denkena, B. and Wegener K. 2007. Mechatronic systems for machine tools. *CIRP annals*. 56(2): 657-686.
- [2] Koren, Y., Heisel, U., Jovane, F., Moriwaki, T., Pritschow, G., Ulsoy, G. and Van Brussel, H. 1999. Reconfigurable manufacturing systems. *CIRP annals*. 48(2):527-540.



- [3] Esmaili, M. and Saadat, M. 2020. Path Planning and Control of an Industrial Robot Used for Opening Tap Hole of an Electric Arc Furnace. *Journal of Modern Processes in Manufacturing and Production*. 9(4): 5-14.
- [4] Xu, B., Shen, J., Liu, S., Su, Q., and Zhang, J. 2020. Research and development of electro-hydraulic control valves oriented to industry 4.0: a review. *Chinese Journal of Mechanical Engineering*. 33(1): 1-20
- [5] Goodarzi, M. 2016. Fractional Order Control of Micro Electro-Mechanical Systems. *Journal of Modern Processes in Manufacturing and Production*. 5(2):55-67.
- [6] Zhang, J., Wang, D., Xu, B., Su, Q., Lu, Z. and Wang, W. 2019. Flow control of a proportional directional valve without the flow meter. *Flow Measurement and Instrumentation*. 67: 131-141.
- [7] Lee, I.Y., Oh, D.H., Ji, S.W. and Yun, S.N. 2015. Control of an overlap-type proportional directional control valve using input shaping filter. *Mechatronics*. 29: 87-95.
- [8] Gu, W., Yao, J., Yao, Z. and Zheng, J. 2019. Output feedback model predictive control of hydraulic systems with disturbances compensation. *ISA transactions*. 88: 216-224.
- [9] Kumaravel, B. and Rajay Vedaraj, I. S. 2015. Modeling and simulation of Hydraulic servo system with different type of controllers. *Journal of Electrical and Electronics Engineering*. 10(1):4-9.
- [10] Dasgupta, K., Ghoshal, S.K., Kumar, S. and Das, J. 2019. Dynamic analysis of an open-loop proportional valve controlled hydrostatic drive. *Proceedings of the Institution of Mechanical Engineers, Part E: Journal of Process Mechanical Engineering*. 233(6): 1245-1256.
- [11] Chen, C.T., Renn, J.C. and Yan, Z.Y. 2011. Experimental identification of inertial and friction parameters for electro-hydraulic motion simulators. *Mechatronics*. 21(1): 1-10.
- [12] Liu, G.P., Daley, S. and Duan, G.R. 2002. Application of optimal-tuning PID control to industrial hydraulic systems. *IFAC Proceedings Volumes*. 35(1) :179-184.
- [13] Adeoye, A. O. M., Aderoba, A. A. and Oladapo, B.I. 2017. Simulated design of a flow control valve for stroke speed adjustment of hydraulic power of robotic lifting device. *Procedia engineering*. 173:1499-1506.
- [14] Shi, J., Quan, L., Zhang, X. and Xiong, X. 2018. Electro-hydraulic velocity and position control based on independent metering valve control in mobile construction equipment. *Automation in Construction*. 94:73-84.