

# Improvement of Existing Public Office Buildings in Nigeria from Users' Perspective Using Lean Thinking – A Pictorial View

<sup>1</sup>\*Adegbenga Adeyemi, <sup>2</sup>David Martin, <sup>3</sup>Rozilah Kasim

<sup>1</sup> Senior Lecturer, Faculty of Environmental Technology, Abubakar Tafawa Balewa University, Bauchi, Nigeria.

<sup>2</sup> Professor, Faculty of Technology Management and Business, Universiti Tun Hussein Onn Malaysia, Batu Pahat, 86400 Johor, Malaysia.

<sup>3</sup> Associate Professor, Faculty of Technology Management and Business, Universiti Tun Hussein Onn Malaysia, Batu Pahat, 86400 Johor, Malaysia.

Received 28.10.2015 ; Accepted 04.04.2016

**ABSTRACT:** This paper gives a pictorial view of the relevance of lean thinking, particularly the application of muda as a supplement to the sustainable improvement diagnosis technique of existing public office buildings, for a fuller assessment of users' requirement in Nigeria. The impact of perceived muda was related to the triple bottom line of sustainable development on perceived job productivity and design features and estimated from end-users' perspective, using diagnostic POE as data acquiring tool, while the confirmatory analysis was done through AMOS, SPSS and MS Excel to explain the relationship between the different variables. The findings showed that muda is inherent in public office buildings and it has highly significant causal effects of 0.66 and 0.76 respectively on perceived job productivity and design features; it also has strong effect sizes of 44% and 58% in explaining both their variances respectively. The result revealed that users require more improvement in facilities as against spatial plan and structures, while there is a medium and positive correlation of 0.48 between perceived job productivity and design features – implying that improvement in design features will consequently lead to improvement in perceived job productivity. The study concludes that lean thinking is relevant to building improvement and could serve as good supplement to the current improvement diagnosis of existing public office buildings, but not as a substitute since data were only collected from users who are not able to provide the required technical data that would otherwise warrant use of equipment.

**Keywords:** Sustainable Improvement, User Requirement, Lean Thinking, Job Productivity, Design Features.

## INTRODUCTION

The improvement of old buildings from existing asset for sustainability is termed sustainable improvement (Mickaityte et al., 2008), and it is an offshoot of Sustainable Development (SD), which was defined as the ability to meet the needs of the present users without compromising the ability of future generations to meet theirs (WCED, 1987). The neglect of existing buildings, which form the bulk of built assets (Brandon & Lombardi, 2010) was identified as a major cause for non-sustainability in the built environment in many

countries, especially in the developing world (Jiboye, 2009; Wood & Muncaster, 2012); they were developed decades ago when sustainability was not a concern (Miller & Buys, 2008). Wood (2006) opined that sustainability cannot be achieved without addressing existing building stock as it is unlikely that new build alone would deliver a sustainable built environment in the near future. Thus, for any significant impact on SD in the built environment, particularly in developing nations, it is essential that existing building stock should be given due consideration (Adeyemi et al., 2015). Mickaityte et al. (2008)

\*Corresponding Author Email: [babaguze@yahoo.co.uk](mailto:babaguze@yahoo.co.uk)

argued that sustainable improvement is a significant problem in current building stock.

According to Brandon & Lombardi (2010), 87% of existing building stock were estimated to still stand by 2050, which therefore goes without saying that existing building stock requires effective sustainable improvement that will sufficiently reflect users' requirements, especially in developing countries like Nigeria with an estimated population of over 170 million people (National Population Commission, 2012), the 6th most populous country in the world, the most populous and largest economy in Africa (Reuters, 2014).

**Literature Review**

**Improvement and Maintenance**

This paper re-evaluated existing buildings and their role to sustainability through the improvement (as against maintenance) of their standards and it adopted McGrath (2012) definition that an improvement makes something better than it was originally whilst retaining their current use, thus a standard superior to an earlier one. In maintenance therefore, the original standard at construction is restored, while in improvement, the original standard is upgraded, thus maintenance strategy thus carried out on non-sustainable existing building can at best reinstate it to its original non-sustainable standard (Adeyemi et al., 2015).

**Sustainable Improvement**

In Nigeria as in most other countries, the sustainable improvement of existing buildings' standards had been mainly through retrofitting for energy and GHG emissions reduction, incorporating the KPIs parameters as related to the TBL components of SD, for reliable diagnosis and decision-

making (Haddad, 2010; Nwokoro & Onukwube, 2011; Ma et al., 2012); nonetheless SD in the built environment is still a far cry, especially in Nigeria (Nwokoro & Onukwube, 2011) as in most developing countries (Haddad, 2010; Wood & Muncaster, 2012). Studies have shown that purported sustainably improved buildings' performance had not adequately reflected occupants' expectations (Monfared & Sharples, 2011; Deuble & de Dear, 2012).

According to Genre, Flourentzos & Stockli (2000), the typical sustainable improvement diagnosis for office buildings basically involves:

- A systematic and complete visit of the building, where all building components are evaluated at sight;
- A complementary survey on the basis of a questionnaire to be filled in by the building users; and
- An analysis of the improvement options.

The nature of improvement however, does not only depend on the diagnosis, but also on the objectives of the building owner and economic situation, and therefore cannot be standardized. The diagnosis user survey tool depends largely on the researcher's choice, while the survey tools usually reflect mainstream green building assessment parameters which were adopted from BREEAM, UK; ASHRAE, LEED, USA; HK BEAM (Building Environmental Assessment Method), Hong Kong; CASBEE (Comprehensive Assessment System for Built Environment Efficiency), Japan; Green Stars (GS), Australia; and Green Building Labels (GBL), China among others in evaluating energy optimization and resource efficiency in the surveys. This paper however did not probe into the survey tools, but rather the nature of data collected on user requirement and

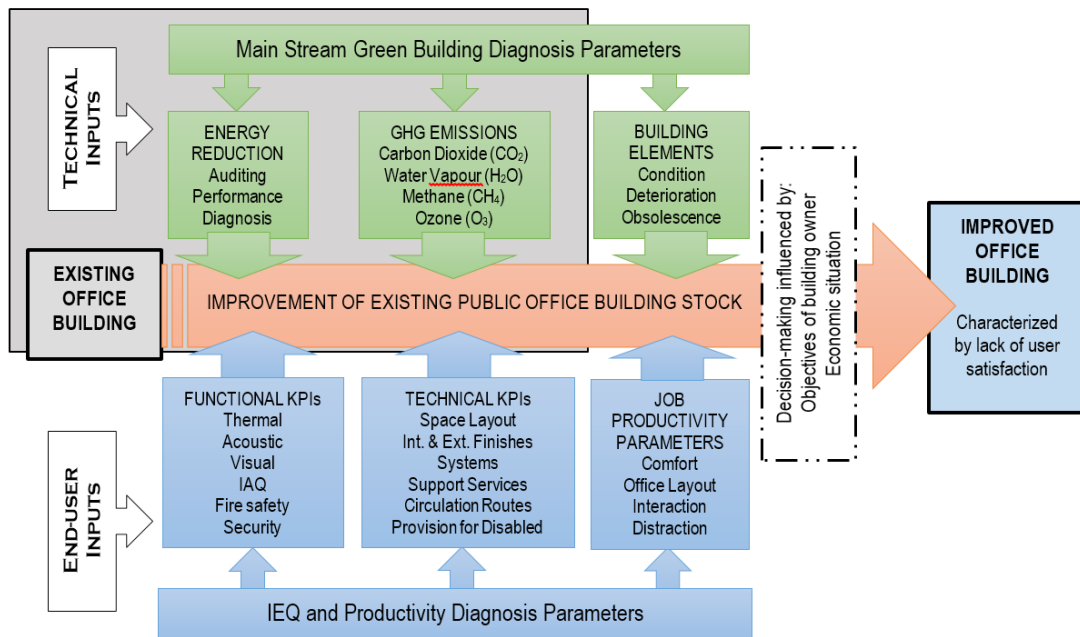

Fig. 1: Typical office building improvement diagnosis.

the type of supplementary data that could deliver a richer data. Fig.1 depicts the typical sustainable improvement diagnosis technique from literature.

### Concepts of Design Features

Arge (2005) listed 3 improvement criteria based on the Norwegian Building Research Institute (NBRI) definitions, related solely to physical design of buildings, and do not include, for example, financial or contractual flexibility, namely:

- (a) Generality - the ability of a building and its space and services to be suitable for multifunctional use without changing its properties;
- (b) Flexibility - the ability of a building to rearrange, take away or add elements and systems when the needs of the users change; and
- (c) Elasticity - the ability of a building to be extended or

partitioned related to changing user or owner needs.

These NBRI concepts were adopted for this study because they are related to the physical design of the building, which is in line with the scope of this study and was thus used as a check for the feasibility of the adoption of the case study. Arge (2005) also classified design features into 3 as shown in Table 1; these were adopted for the study because they are relevant to the study objectives and scope, which was limited to the super structure only.

The Benefits of Sustainable Improvement of Existing Buildings Wood & Muncaster (2012) observed that, despite the poor construction and condition of older properties, they are still attractive to many in the population; they are part of existing urban communities and are often seen as more appealing visually and cheaper to purchase than new buildings on barren sites at the periphery. The benefits of sustainable improvement are thus summarized in Table 2.

Table 1: Components of design features. (Source: adapted from Arge, 2005)

S/No.	Design Features sub-constructs	Items (Observed variables)
1	Spatial Plan (SPL)	Offices design (OFFD)/layout (OFLT); ancillary rooms' design (ARMD)/layout (ARML); and overall building design (BLGD).
2	Structure (STR)	Walls (WALL); floors (FLOR); windows (WIND); doors (DORR); ceiling (CEIL).
3	Facilities (FAC)	Water (WATR); electricity (ELTR); ICT facilities (ICTF); security (SECU); and other facilities such as Parking lot, fire-fighting equipment, safety measures, storage facilities, cooling devices, etc. (OFAC).

Table 2: Summary of the benefits of sustainable improvement.

S/No	Author & Year	Benefit a Improvement to Demolition and Rebuild
1	Hui <i>et al.</i> (2008); Wood & Muncaster (2012)	Upgrade the living environment, increase property values, reduce the urgency for redevelopment, and enhance public safety and the image of city, in addition to the extension of the economic life of buildings.
2	Teo & Lin (2011)	Significantly helps in combating building deterioration and delivered sustainability.
3	Power (2008); Love & Bullen (2009)	Lower material, transport and energy consumption and pollution and thus more environmentally friendly and make significant contribution to sustainability.
4	Reed & Wilkinson (2005); Wilkinson <i>et al.</i> (2011)	Reduces maintenance cost which often is neglected in favor of more attractive political goals, thus lowering operating cost.
5	Ma <i>et al.</i> (2012); Shrestha <i>et al.</i> (2012).	Construed to be far cheaper financial-wise than to demolish and rebuild.
6	Bullen & Love (2010); Go-hardani & Bjork (2012)	Deemed a safer and environmentally friendly strategy as improvement offers a more efficient and effective process of dealing with buildings than demolition.
7	Bullen & Love (2011)	Considered by many researchers as an effective SD implementation strategy for existing buildings.

**Factors Influencing Improvement of Existing Building**

Gohardani & Bjork (2012) argued that avoidance of demolition within the existing building stock is impractical in certain cases bordering on an array of interacting financial variables despite the disadvantages of building demolition. Accordingly, when considering a building for improvement, it is essential to also examine the following issues opined by Shipley et al. (2006), Itard & Klunder (2007) and Bullen & Love (2010), which are summarized in Fig 2.

**User Requirement and Job Productivity**

According to Jylhä & Junnila (2013), facility management

literature in recent years had discussed the shift from bricks and mortar to an end-user-driven mindset; the focus is no longer only on cost minimization and real estate operations but rather on supporting endusers, while Israelson & Hansson (2009) opined that knowledge of the expectations of occupiers is required in order to make proper decisions connected with the improvement of office buildings. Jylhä & Junnila (2014) thus rightly opined that the ultimate goal is to produce and deliver occupants’ requirements and only the occupants themselves can define it. Wilkinson et al. (2011) studied users’ satisfaction in sustainable office buildings and illustrated the impact of office building improvement on job productivity as in Fig. 3.

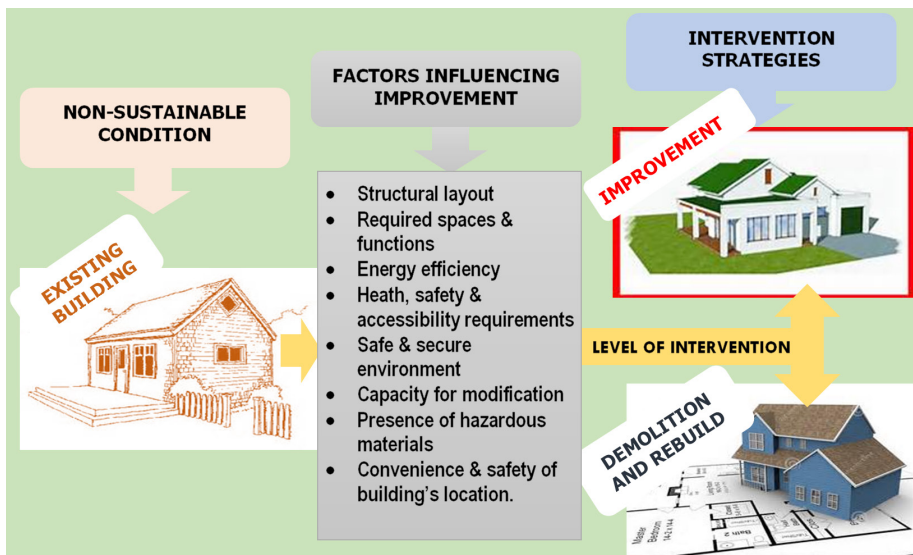

Fig. 2: Factors influencing building improvement impression.

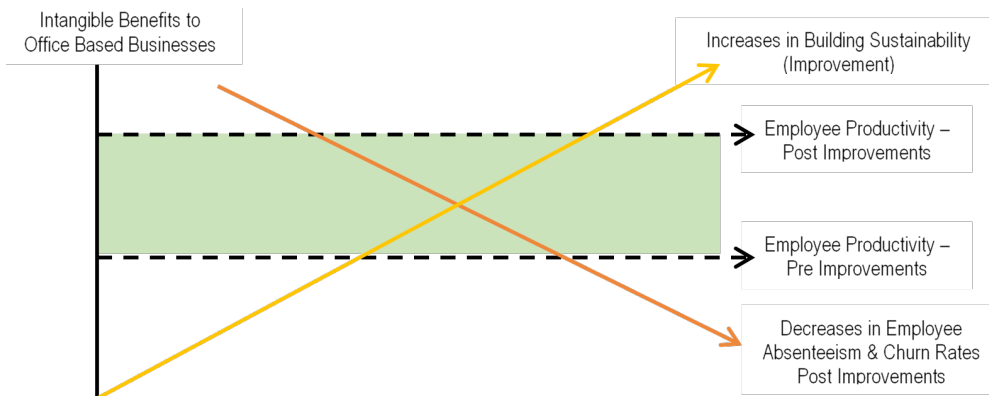

Fig. 3: Building improvement effect on job productivity. (Source: Wilkinson et al., 2011)

Haynes (2008) argued that a sustainably improved office can have direct impact in increasing productivity (which is the essence of an office) and is a crucial factor in job satisfaction, staff recruitment and retention, while personal space, climate control and daylight are also assumed to be important factors in a good working environment (Birkeland, 2012). The

relationship between office environment and job productivity from literature is illustrated in Fig. 4.

Haynes (2007) developed a theoretical framework of job productivity from users' perspective (Fig.5) which was adopted for this study. The components as used in this study is shown in Table 3.



Fig. 4: Office environment and job productivity relationship impression.

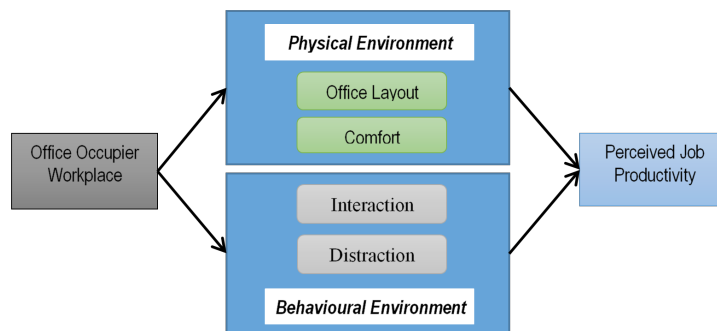

Fig. 5: Theoretical framework of job productivity. (Source: Haynes, 2007)

Table 3: Perceived job productivity sub-constructs. (Source: adapted from Haynes, 2008)

S/N	Sub-Constructs	Items (Observed variables)
1	Comfort (CFT)	Temperature (TEMP); natural lighting (DAYL); décor (OVRF); cleanliness (HYGN); security (SCTY).
2	Office layout (OFL)	Storage facilities (STRR); office shape (OFSH) and size (OFSZ); ergonomics (OFEG); circulation routes (PSSG).
3	Interaction (INT)	Social interaction (SINT); work interaction (WINT); aesthetically pleasing (AEST) i.e. modern attractiveness with regular upkeep; refreshment areas (RFSH); creative environment (CREN).
4	Distraction (DST)	Noise/concentration (NOIS); toilet sanitary condition (TOIS); downtime (DNTM); health due to IAQ (HLTH); electricity (ELEC).

### Concept of Lean Thinking

Lean has the underlying philosophy that by identifying and eliminating muda, standard can be improved to meet users' requirement. According to Lamb (2011), lean determines what is truly important to the end-user and consequently reshapes, to deliver it; along the way, muda drops out. Nicholas & Soni (2006) noted that the 2 overarching philosophy of lean thinking for sustainability are elimination of muda and continuous improvement (or kaizen in Japanese). Ohno (1988) classified muda into 7 drivers, namely: defect/error, inventory, waiting/delay, motion, transportation, over-processing and overproduction; Womack & Jones (1996) later added the 8th

- human talent.

Nicholas & Soni (2006), Finch (2010) and Schipper & Swets (2010) opined that muda is universal, appearing in every situation and remain constant. They argued that as any new situation is approached for the application of lean thinking, the definitions of the drivers can be customized to fit the specific circumstances. Thus, the muda drivers adopted for this study were modified to suit the concept and objectives of this study as depicted in Table 4. According to DeVellis (2012), theory plays a vital role in the conceptualization of measurement variables. Figure 6 depicts the concept of lean improvement adapted for the study.

Table 4: Concept of muda drivers for office buildings. (Source: Adeyemi et al., 2014)

S/N	Muda	Modified Description
1	Defect/Error	Situation where one or more elements of a building do not perform their intended function (Georgiou, 2010); and failure in the function, performance, statutory or user requirements of a building that manifests itself within the structure, fabric services or other facilities of the building (Ilozor, Okoroh & Egbu, 2004).
2	Inventory	Storage facilities; and building materials kept for maintenance that are not necessary or have short life spans.
3	Waiting/Delay	Delay, due to inadequate provisions for access to carry out maintenance activities, etc.
4	Motion	Wasted human motion is related to workplace: ergonomic design negatively affecting productivity, quality & safety e.g. walking, reaching and twisting (Dennis, 2007).
5	Transportation	Distant location of complimentary offices and other ancillary rooms causing unnecessary movements for users.
6	Over-processing	Adding Design Features not needed by users, e.g. bath tubs in general convenience; irregular office shapes that reduces functionality; etc.
7	Overproduction	.Large accommodation space, too many corridors, etc. not appreciated by users
8	Human talent	Non-inclusion of end-users' input (or talent) in design, maintenance or improvement policies. How could people be better involved in continuous improvement?

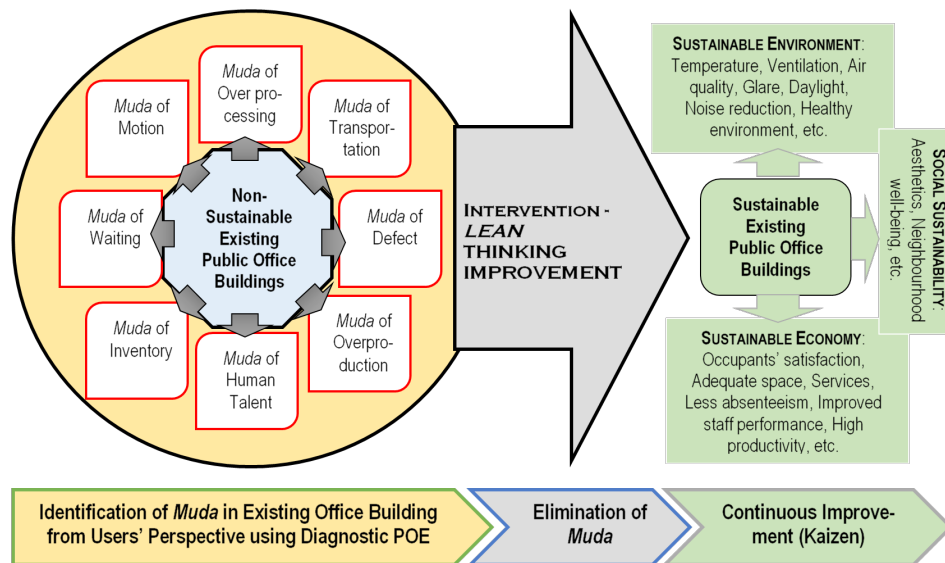

Fig. 6: Concept of lean improvement. (Source: Adeyemi, Martin & Kasim, 2015)



**MATERIALS AND METHODS**

**Research Design**

The research design adopted is illustrated in Fig. 7, it depicts the overall strategy chosen to integrate the different components of the study in a coherent and logical way, thus ensuring that the research effectively addressed the research problem (De Vaus, 2001). Figure 7 depicts the research process.

The confirmatory study adopted the quantitative method, while the research strategy involved the use of survey, direct observation and case study approach. The diagnostic POE data acquiring tool was adopted for this study, with its working depth limited to the systematic evaluation of opinion to determine the relevance of muda to the sustainable improvement of public office buildings from users’ perspective as a feasible supplement to improvement diagnosis technique. The causal effect, effect size and practical significance (Adams & Lawrence, 2015) were used in determining the relevance of lean thinking with respect to the study objectives and hypotheses, using AMOS.

**The Case Study**

The Federal Secretariat, Bauchi, a massive public building in

Nigeria was chosen as case study because of more dire need for improvement in developing nations (Nwokoro & Onukwube, 2011; Wood & Muncaster, 2012). Eisenhardt (1989) suggested that a single study area method tends to be more appropriate to confirm or challenge a theory or address a rare or unusual situation. The study area was also selected because of the circumstances surrounding it and the researcher’s in-depth local knowledge of the building (Fenno, 1986; Yin, 1994).

**Standard of measurement**

According to Adams & Lawrence (2015), in addition to the test of statistical significance, additional measures, apart the causal effect - the effect size (i.e. R2) and practical significance (i.e. P-value) were used to interpret the meaning and importance of statistical findings; these standards help to better understand and interpret the results of a study in testing the relevance of lean thinking with respect to the research objectives and hypotheses. Table 5 below shows the classification of R2 effect size range by Cohen (1988) and Adams & Lawrence (2015). For practical significance, P-value is deemed significant at <0.05.

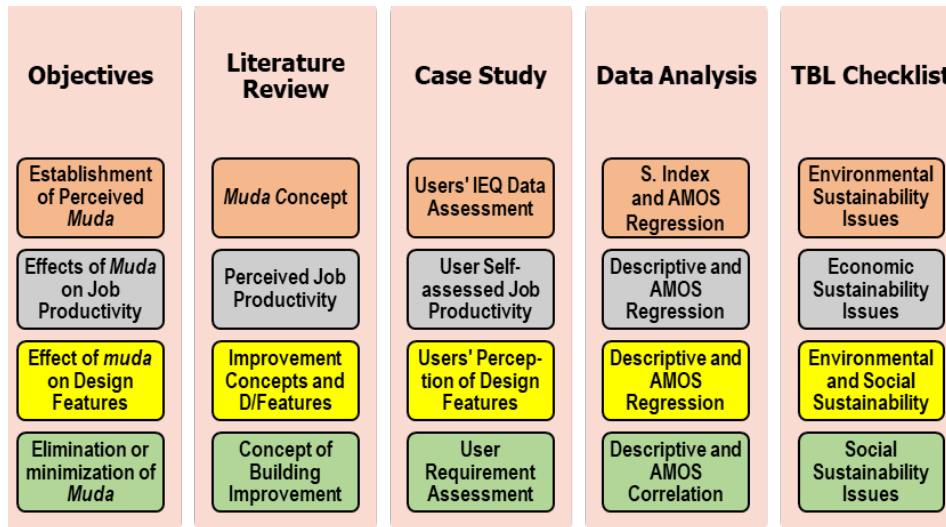

Fig.7: Research process.

Table 5: Classification of R<sup>2</sup>-effect sizes.

Cohen (1988)		Adams & Lawrence (2015)	
Range of R <sup>2</sup>	The Effect Size	Effect Size Range	Interpretation
Below 0.13 (i.e. 13%)	Small Range	1-4%	Weak
Between 0.13 to 0.26	Medium Range	9-25%	Moderate
Above 0.26	High Range	25-64%	Strong

### Assessment Model

Fig.8 depicts the assessment framework relating all the variables developed for the evaluation of the relevance of lean thinking to the sustainable improvement public office buildings from existing stock. It basically establishes the existence of perceived muda and its effects on perceived job productivity and design features from users' perspective in the case study, and the relationship between perceived job productivity and

design features; with hypotheses testing.

### RESULT AND DISCUSION

#### Modified Measurement Models Using CFA

The Confirmatory Factor Analysis (CFA) was used to delete all items with low factor loading of <0.60 in order to achieve the good Fitness Indexes for the proposed structural model as shown in Tables 6 to 8.

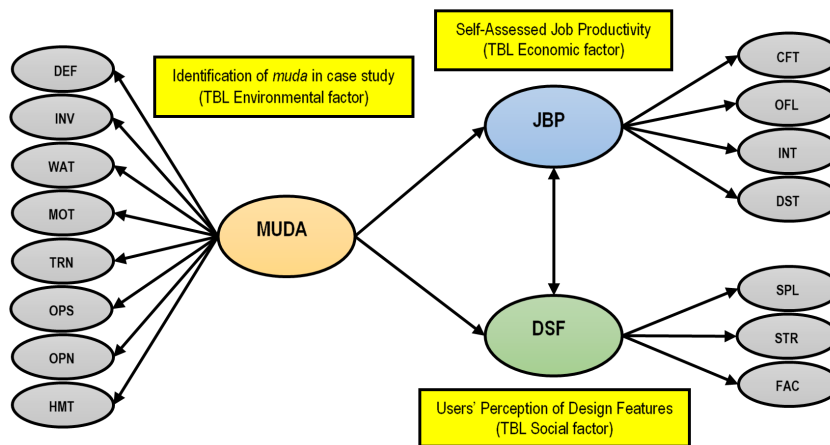

Fig. 8: Assessment framework.

Table 6: CFA results for the muda measurement models.

Muda Constructs	Items	Factor Loading	Cronbach's alpha (above 0.7)	CR (above 0.6)	AVE (above 0.5)	
Defect (DEF)	ACOU	0.80	<b>0.877</b>	<b>0.88</b>	<b>0.65</b>	
	THRC					This item was deleted due to low factor loading
	DISA	0.71				
	CPKG	0.87				
	SFTM	0.83				
	VISC					This item was deleted due to low factor loading
	STOR	0.84				
Inventory (INV)	MATS	0.87	<b>0.878</b>	<b>0.88</b>	<b>0.64</b>	
	DURA	0.82				
	AVAL	0.78				
	ACCES	0.68				
(Waiting (WAT	COST	0.90	<b>0.856</b>	<b>0.86</b>	<b>0.61</b>	
	IDEN					This item was deleted due to low factor loading
	DAMG	0.81				
	DSRP	0.71				
	ESYM	0.65				
Motion (MOT)	ERGO		<b>0.849</b>	<b>0.84</b>	<b>0.57</b>	
	SZFR	0.89				This item was deleted due to low factor loading
	SZOP	0.78				
	OCFT	0.68				
	DIST	0.72				
Transportation (TRN)		<b>0.893</b>	<b>0.89</b>	<b>0.68</b>		



Continuie of Table 6: CFA results for the muda measurement models.

<b>(Over-Processing (OPS</b>	OREN	0.82			
	CIRR	0.86			
	AXRM	0.89			
	OPNG	0.78	<b>0.807</b>	<b>0.81</b>	<b>0.52</b>
	WALF	This item was deleted due to low factor loading			
	CEIF	0.75			
	ELMH	0.72			
<b>(Over Production (OPN</b>	OVQU	0.62			
	ATOI	0.86	<b>0.921</b>	<b>0.92</b>	<b>0.74</b>
	QTOI	0.89			
	OFSP	This item was deleted due to low factor loading			
	PSTR	0.82			
<b>(Human Talent (HMT</b>	COMM	0.88			
	PPOE	0.82	<b>0.880</b>	<b>0.88</b>	<b>0.65</b>
	USVY	0.78			
	MPOL	0.84			
	PERC	0.79			

Table 7: CFA results for the job productivity measurement models.

<b>Job Productivity Constructs</b>	<b>Items</b>	<b>Factor Loading</b>	<b>Cronbach's alpha (above 0.7)</b>	<b>CR (above 0.6)</b>	<b>AVE (above 0.5)</b>
<b>Comfort (CFT)</b>	DAYL	0.75	<b>0.865</b>	<b>0.88</b>	<b>0.64</b>
	TEMP	This item was deleted due to low factor loading			
	HYGN	0.67			
	OVRF	0.88			
	SCTY	0.78			
<b>Office Layout (OFL)</b>	STRR	0.92	<b>0.911</b>	<b>0.91</b>	<b>0.72</b>
	OFSH	0.80			
	OFSZ	0.83			
	OFEG	This item was deleted due to low factor loading			
<b>Interaction (INT)</b>	PSSG	0.85			
	SINT	0.95	<b>0.934</b>	<b>0.86</b>	<b>0.77</b>
	WINT	0.86			
	AEST	0.80			
	RFSH	0.89			
<b>Distraction (DST)</b>	CREN	This item was deleted due to low factor loading			
	NOIS	0.83	<b>0.885</b>	<b>0.88</b>	<b>0.65</b>
	TOIS	0.95			
	HLTH	This item was deleted due to low factor loading			
	DNTM	0.61			
	ELEC	0.82			

Table 8. CFA results for the design features measurement models.

Design Features Constructs	Item	Factor Loading	Cronbach's alpha (above 0.7)	CR (above 0.6)	AVE (above 0.5)	
Spatial Layout (SPL)	OFFD	0.75	<b>0.882</b>	<b>0.88</b>	<b>0.65</b>	
	OFLT	0.80				
	ARMD	0.82				
	ARML	0.86				
	BLGD	This item was deleted due to low factor loading				
Structure (STR)	WALL	0.82	<b>0.923</b>	<b>0.92</b>	<b>0.75</b>	
	FLOR	0.91				
	WIND	This item was deleted due to low factor loading				
	DORR	0.84				
	CEIL	0.89				
Facilities (FAC)	WATR	0.94	<b>0.964</b>	<b>0.96</b>	<b>0.87</b>	
	ELTR	0.96				
	ICTF	0.93				
	OFAC	This item was deleted due to low factor loading				
	SECU	0.90				

#### Establishment of Muda

Fig. 9 is the proposed structural model and it showed the standardized beta coefficients of the muda drivers; the driver with the largest beta coefficient makes the strongest unique contribution to explaining the perceived muda (Pallant, 2011). Table 9 shows the ranking of the drivers based on their respective beta coefficients which ranged from 0.848 to 0.472 from Inventory to Waiting in order of prominence. The corresponding R<sup>2</sup>s are deemed strong (Awang, 2015; Adams & Lawrence, 2015), except for Waiting (WAT) with R<sup>2</sup> of 0.22 construed as moderate.

#### Causal Effects of Muda on Dependent Variables

Fig. 9 and Table 10 gives the estimates from the proposed structural model for the causal effects of perceived muda on perceived job productivity and design features. Muda has a causal effect of 0.661 on perceived job productivity (JBP), thus when muda goes up by 1 unit job productivity will also go up by 0.661 unit. Likewise, it has a causal effect of 0.760 on design features, such that when muda goes up by 1 unit, design feature will also go up by 0.760 unit. The result also showed significant coefficients (i.e. P-value) of <0.05, indicating their practical significance.

Table 9: Regression weights, P-value and ranking of drivers predicting muda.

Muda Drivers	Path	Construct	Beta Estimate	S.E.	C.R.	P-Value	Result	R <sup>2</sup>	Beta Ranking
Human Talent		MUDA	.523	109.	7.000	***	Significant	0.27	7
Overproduction		MUDA	.770	231.	7.082	.004	Significant	0.59	4
Over-processing		MUDA	.782				Reference Point	0.61	3
Transportation		MUDA	636.	101.	7.531	***	Significant	0.40	6
Motion		MUDA	.669	237.	5.980	***	Significant	0.45	5
Waiting		MUDA	.472	057.	3.814	.025	Significant	0.22	8
Inventory		MUDA	.848	098.	9.006	***	Significant	0.72	1
Defect		MUDA	.796	092.	5.730	***	Significant	0.63	2

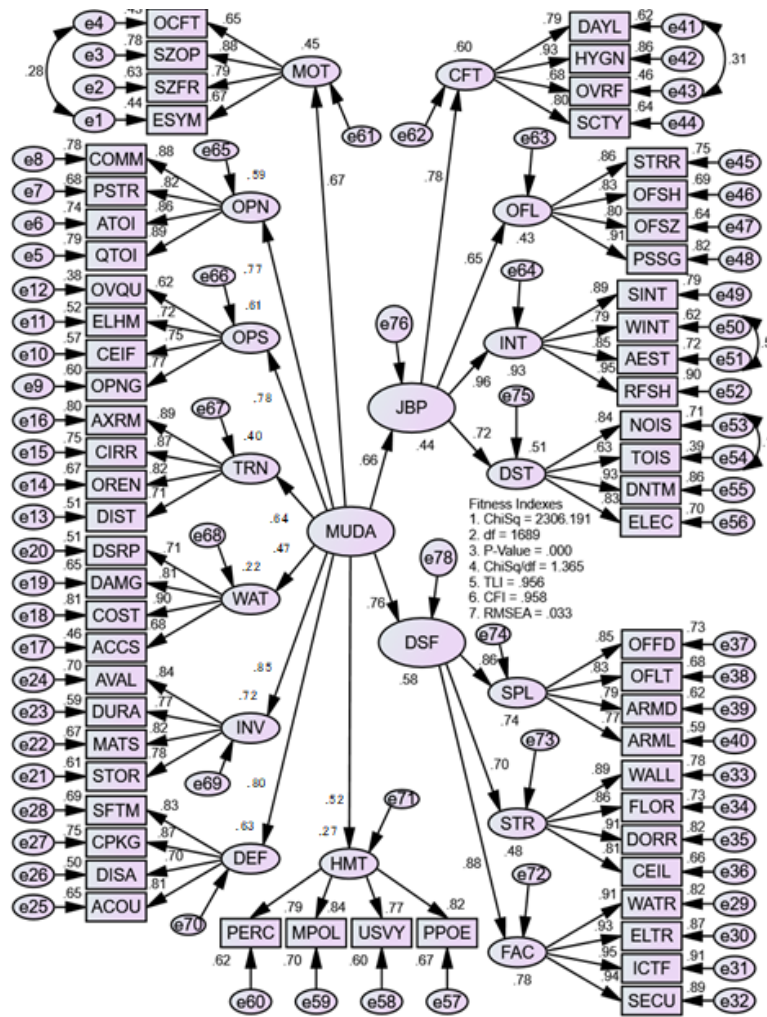

Fig. 9: The proposed structural model.

Table 10: Regression weights and P-value of the causal effects of muda.

Constructs	Path	Construct	Beta Estimate	S.E.	C.R.	P-Value	Result
JBP		MUDA	.661	.162	5.944	***	Significant
DSF		MUDA	.760	.265	6.397	***	Significant

**Effect Sizes of Muda on Dependent Variables**

Figure 10 revealed that muda has an effect size (R2) of 0.44 on perceived job productivity, indicating that muda explains 44% of the variance in perceived job productivity. Muda also has an effect size of 0.58 on design features, i.e. it explains 58% of the variance in design features. According to Adams & Lawrence (2015), these are strong effect sizes, while the results

were highly significant (Table 10).

**Correlation between the Dependent Variables**

Fig. 10 depicts a medium and positive correlation of 0.48 between perceived job productivity and design features, implying that as the design features are improved, job productivity will equally improve and thus killing two birds with one stone. Table 11 shows that it is also highly significant.

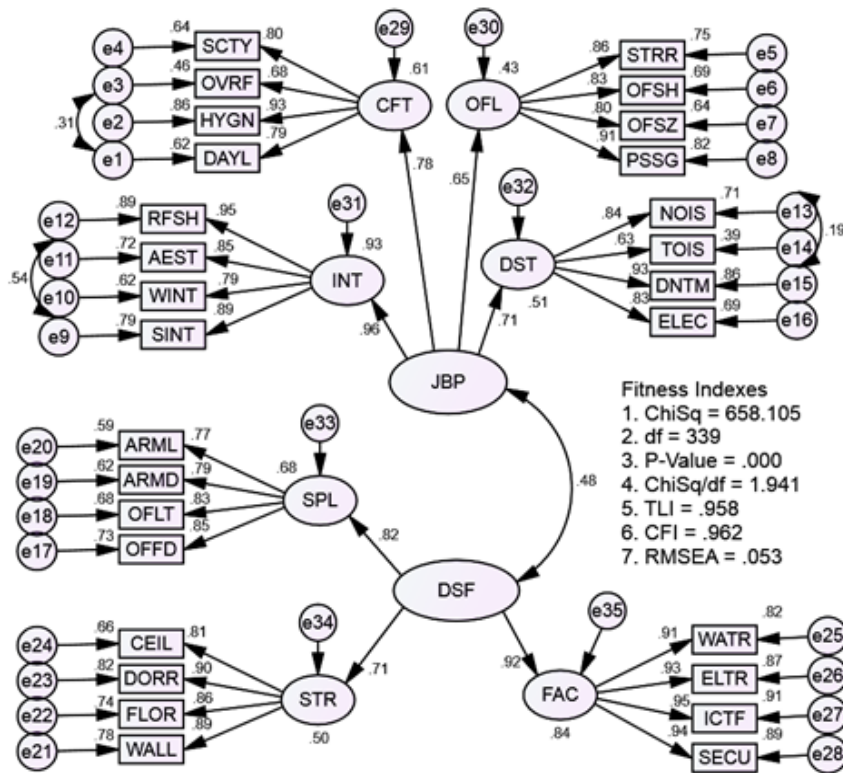

Fig. 10: Correlation between job productivity and design features.

Table 11: The estimate of the relationship between job productivity and design features.

Endogenous Construct	Path	Endogenous Construct	Beta Estimate	S.E.	C.R.	P-Value	Result
JBP		DSF	.484	.029	6.062	***	Significant

### CONCLUSION

The paper established that muda is inherent in public office buildings in Nigeria and thus supports the claim that it is universal. The drivers are ranked in the following order of prominence – Inventory, Defect, Over-processing, Overproduction, Motion, Transportation, Human Talent and Waiting based on their unique contributions and effect sizes. Perceived muda has causal effects of 0.66 and 0.76 respectively on perceived job productivity and design features, implying that as muda increases by 1 unit, the effects on the dependent variables will also increase by the correspondent respective figures. A medium and positive correlation of 0.48 between the dependent variables implies that as design features are improved, job productivity will equally improve, thus killing two birds with one stone. All the results have practical

significance with P-values of <0.05.

### ENDNOTES

1. Schipper & Swets, 2010; Finch, 2010

### REFERENCES

- Adams, K. A. & Lawrence, E. K. (2015). *Research Methods, Statistics and Applications*. Los Angeles: SAGE Inc.
- Adeyemi, A., Martin, D. & Kasim, R. (2014). Application of Lean Thinking to the Built Environment in Developing Nations for Sustainability. *Journal of Environmental Design & Construction Management*, 2(3), 1-17.
- Adeyemi, A., Martin, D. & Kasim, R. (2015). Research Framework for Identification of Waste and Inefficiencies in Existing Public Office Buildings in Developing Nations

- for Sustainability. *British Journal of Applied Science & Technology*, 5(1), 60-75.
- Arge, K. (2005). Adaptable Office Buildings: Theory and Practice. *Facilities*, 23(3), 119-127.
- Awang, Z. (2015). *SEM Made Simple*. Selangor: MPWS.
- Birkeland, J. (2012). Design Blindness in Sustainable Development: From Closed to Open Systems Design Thinking. *Journal of Urban Design*, 17(2), 163-187.
- Brandon, P. & Lombardi, P. (2010). *Evaluating Sustainable Development in the Built Environment*. New York: John Wiley & Sons.
- Bullen, P. A. & Love, P. E. D. (2010). *The Rhetoric of Adaptive Reuse or Reality of Demolition: Views from the Field*. *Cities*, 27(4), 215-224.
- Bullen, P. & Love, P. (2011). A New Future for the Past: A Model for Adaptive Reuse Decision-Making. *Built Environment Project and Asset Management*, 1(1), 32-44.
- Cohen, J. (1988). *Statistical Power Analysis for the Behavioral Sciences*. 2nd ed. New Jersey: Lawrence Erlbaum Associates Publishers.
- De Vaus, D. (2001). *Research Design in Social Research*. 1st ed. London: SAGE Publications.
- Dennis, P. (2007). *Lean Production Simplified*. 2nd ed. New York: Productivity Press.
- Deuble, M. P. & de Dear, R. J. (2012). Green Occupants for Green Buildings: The Missing Link? *Building and Environment*, 56(1), 21-27.
- DeVellis, R. F. (2012). *Scale Development: Theory and Applications*. 3rd ed. Los Angeles: SAGE Publications.
- Eisenhardt, K. M. (1989). Building Theories from Case Study Research. *Academy of Management Review*, 14(4), 532-550.
- Fenno R. (1986). Observation, Context, and Sequence in the Study of Politics. *American Political Science Review*, 80(1), 3-15.
- Finch, E. (2010). *Lean Facilities Management - Transplanting a Manufacturing Approach?* Paper presented at ARVO workshop, Aalto University, Espoo, 22 June.
- Genre, J. L., Flourentzos, F. & Stockli, T. (2000). Building Refurbishment: Habitat Upgrading. *Energy and Buildings*, 31(2), 155-157.
- Georgiou, J. (2010). Verification of a Building Defect Classification System for Housing. *Structural Survey*, 28(5), 370-383.
- Gohardani, N. & Bjork, F. (2012). Sustainable Refurbishment in Building Technology. *Smart and Sustainable Built Environment*, 1(3), 241-252.
- Haddad, H. M. (2010). *A Framework of Sustainable Design for the Region of Palestine*. The Pennsylvania State University: Master's Thesis.
- Haynes, B. P. (2007). Job productivity: A Theoretical Framework. *Journal of Corporate Real Estate*, 9(2), 97-110.
- Haynes, B. P. (2008). The Impact of Office Layout on Productivity. *Journal of Facilities Management*, 6(3), 189-201.
- Hui, E. C. M., Wong, J. T. Y. & Wan, J. K. M. (2008). The Evidence of Value Enhancement Resulting from Rehabilitation. *Facilities*, 26(1/2), 16-32.
- Ilozor, B. D., Okoroh, M. I. & Egbu, C. E. (2004). Understanding Residential House Defects in Australia from State of Victoria. *Building and Environment*, 39 (3), 327-337.
- Israelson, N. & Hansson, B. (2009). Factors Influencing Flexibility in Buildings. *Structural Survey*, 27 (2), 138-147.
- Itard, L. & Klunder, G. (2007). Comparing Environmental Impacts of Renovated Housing Stock with New Construction. *Building Research and Information*, 35(3), 252-267.
- Jiboye, A. D. (2009). The Challenges of Sustainable Housing and Urban Development in Nigeria. *Journal of Environmental Research and Policies*, 4(3), 23-27.
- Jylhä, T. & Junnila, S. (2013). Learning from Lean Management – Going Beyond Input-Output Thinking. *Facilities*, 31(11), 454-467.
- Jylhä, T. & Junnila, S. (2014). The State of Value Creation in the Real-Estate Sector – Lessons from Lean Thinking. *Property Management*, 32(1), 28-47.
- Lamb, R. G. (2011). Make the Case for 'Lean Thinking' in Maintenance. *Hydrocarbon Processing*, 90 (11), 69-71.
- Love, P. E. D. & Bullen, P. A. (2009). Toward the Sustainable Adaption of Existing Facilities. *Facilities*, 27 (9), 357-367.
- Ma, Z., Cooper, P., Daly, D. & Ledo, L. (2012). Existing Building Retrofits: Methodology and State-of-the-Art. *Energy and Buildings*, 55, 889-902.
- McGrath, J. (2012). *Difference between Repairs, Maintenance and Improvements*. Switzer Daily. Retrieved June 9, 2013, from <http://www.switzer.com.au/TheExperts/JohnMcGrath>.
- Mickaityte, A., Zavadskas, E. K., Kaklauskas, A. & Tupenaite, L. (2008). The Concept Model of Sustainable Buildings Refurbishment. *International Journal of Strategic Property Management*, 12 (1), 53-68.
- Miller, E. & Buys, L. (2008). Retrofitting Commercial Office Buildings for Sustainability: Tenants' Perspectives. *Journal of Property Investment & Finance*, 26(6), 552-561.
- Monfared, I. G. & Sharples, S. (2011). *Occupants' Perceptions and Expectations of a Green Office Building: A Longitudinal Case Study*. *Architectural Science Review*, 54(4), 344-355.
- National Population Commission NPC (2012). [www.population.gov.ng](http://www.population.gov.ng) (accessed 13th July, 2013).
- Nicholas, J. & Soni, A. (2006). *The Portal to Lean Production: Principles and Practices for Doing More with Less*. Boca Raton: Auerbach Publication.
- Nwokoro, I. & Onukwube, H. N. (2011). Sustainable or Green Construction in Lagos, Nigeria: Principles, Attributes and Framework. *Journal of Sustainable Development*, 4 (4), 166-174.
- Ohno, T. (1988). *Toyota Production System*. Portland: Productivity Press.
- Pallant, J. (2011). *SPSS Survival Manual*. 4th ed. Crow's Nest: McGraw-Hill.
- Power, A. (2008). Does Demolition or Refurbishment of Old and Inefficient Homes Help to Increase our Environmental, Social and Economic Viability? *Energy Policy*, 36 (12), 4487-4501.

Reed, R. G. & Wilkinson, S. J. (2005). The Increasing Importance of Sustainability for Building Ownership. *Journal of Corporate Real Estate*, 4 (7), 339 – 350.

Schipper, T. & Swets, M. (2010). *Innovative Lean Development*. New York: Productivity Press.

Shipley, R., Utz, S. & Parsons, M. (2006), Does Adaptive Reuse Pay? A Study of the Business of Building Renovation in Ontario, Canada. *International Journal of Heritage Studies*, 12 (6), 505-520.

Shrestha, H. D., Yatabe, R., Bhandary, N. P. & Subedi, J. (2012). Vulnerability Assessment and Retrofitting of Existing School Buildings: A Case Study of Aceh. *International Journal of Disaster Resilience in the Built Environment*, 3(1), 52–65.

Teo, E. A. L. & Lin, G. (2011). Determination of Strategic Adaptation Actions for Public Housing in Singapore. *Building and Environment*, 46 (7), 1480–1488.

WCED, U. (1987). *Our common future*. World Commission

on Environment and Development Oxford University Press.

Wilkinson, S. J., Reed, R. & Jailani, J. (2011). *User Satisfaction in Sustainable Office Buildings: A Preliminary Study*. In PRRES 2011: Proceedings of the 17th Pacific Rim Real Estate Society Annual Conference. Pacific Rim Real Estate Society.

Womack, J. P. & Jones, D. T. (1996). *Lean Thinking: Banish Waste and Create Wealth in Your Organization*. New York: Simon & Schuster.

Wood, B. (2006). The Role of Existing Buildings in the Sustainability Agenda. *Facilities*, 24(1/2), 61–67.

Wood, B. & Muncaster, M. (2012). Adapting from Glorious Past to Uncertain Future. *Structural Survey*, 30 (3), 219–231.

Reuters. (2014). Retrieved 15th April, 2014 from [www.reuters.com/article/2014/04/11/thinksecurityafrica](http://www.reuters.com/article/2014/04/11/thinksecurityafrica).

Yin, R. (1994). *Case Study Research. Design and Methods*. 2nd ed. Thousand Oaks: SAGE Publications.