



# Load Sharing Control of Parallel Inverters with Uncertainty in the Output Filter Impedances for Islanding Operation of AC Micro-Grid

Pourya Sarvghadi, Mohammad Monfared\*

Faculty of Engineering, Ferdowsi University of Mashhad, Mashhad, Iran, Pourya.sarvghadi@mail.um.ac.ir, M.monfared@um.ac.ir

## Abstract

Parallel connection of inverter modules is a solution to increase reliability, efficiency and redundancy of inverters in Micro-Grid system. Proper load sharing among parallel inverters is a key point. The circulating current among the inverters can greatly reduce the efficiency or even cause instability of the system. In this paper, a control strategy for improving the load sharing performance in order to reduce the circulating current among parallel inverters in islanding micro-grid is proposed. The control strategy includes an estimator for filter parameters, which compensates for any possible uncertainty or drift of their value. Also a double loop feedback control, with an outer voltage and inner current control, is adopted that provides excellent operation at transient and steady-state conditions. Finally, the proposed control and estimation algorithms are confirmed through simulations of two 2kW parallel connected single phase inverters.

Keywords: Parallel inverters, Load sharing, Circulating current, Predictive control.

Article history: Received 02- May-2017; Revised 15-May-2017; Accepted 01-Jun-2017.

© 2017 IAUCTB-IJSEE Science. All rights reserved

## 1. Introduction

DC-to-AC converters appear in many applications; especially uninterruptible power supplies (UPS) and grid integration of renewable energy. As electrical grid, the range of non-linear and single phase load has recently increased; inverters play a key role in the electrical grid which can both operates in grid-connected and islanding mode. In the meantime, due to some of its advantages such as high reliability, redundancy, increase power capacity, fault tolerance and better maintenance, the use of parallel inverters as a practical topic has arisen. In addition, the use of parallel inverters in compression with that of central inverters are more useful [1]. One of other advantages of these parallel inverters is that, they are cost effective because the power inverter modules do not require costly semiconductor devices with high ratings. Although, there are many benefits for parallel inverters, the presence of circulating current may decrease the system performance. This current reduces the efficiency and also causes flowing useless power among parallel inverters. A relatively large circulating current may even lead to instability of the system [2]. The reasons of producing such a current

are as follows: different instantaneous voltages of inverters, asynchronous gating pulses, difference in output filter impedances and dissimilar semiconductor elements. Two main control methods have been proposed for suppression of circulating currents. These controllers are classified into two main groups as power droop theory and wire interconnected [3]–[7]. In droop control methods, load sharing is performed by control of voltage and frequency. In this method any intercommunication among parallel inverters is not required.

Deviation of the voltage and frequency is a major drawback in these methods, which can lead to the creation of circulating current among parallel inverters [8]. Central control [9]–[12], circular chain control [13], [14], master-slave control [15], [16], and distributed control [17]–[19] are known as the main techniques of wire interconnected parallel inverters. Information exchange and Thevenian model are used for parallel inverters among these controllers, in order to regulate the output voltage that keeps the circulating current small. Load current is measured in the centralized controller and then reference current

for each inverter is determined by using current sharing unit and according to the number of inverters. Synchronous signal, which is generated from the central unit, is necessary among parallel inverters in this method. Current sharing error among parallel inverters can occur because of difference in frequency and phase. In central limit control, which is a subset of the above methods, all parallel inverters have the same configuration and each unit tracks the average current that is produced by the central controller. In this method, the reference current for each inverter must be sent to all of them with high bandwidth communication line. All of the modules in circular chain control have the same control structure, each of them tracks the previous inverter current and the first inverter tracks the last inverter current. Although in this method proper current sharing can be achieved, it should be taken into account that a failure at one of the parallel inverters can lead to the instability of the

system or losing the whole system. In the master-slave control, the master unit regulates the output voltage and the slave parallel inverters track the reference current that is generated by the master unit. The reliability and redundancy of the system is a key concern, because if the master unit fails, the whole system is lost. The common advantages of these techniques can be mentioned as appropriate load sharing and proper output voltage regulation. Despite the above benefits, drawbacks such as requiring high bandwidth communication lines, decreased reliability, system modularity and fewer faults tolerant are major challenges in parallel inverters application. Also, any variation in filter impedance may lead to a lack of proper load sharing among the parallel inverters. With identification of this impedance any control strategy can be modified in order to achieve proper load sharing among parallel inverters.

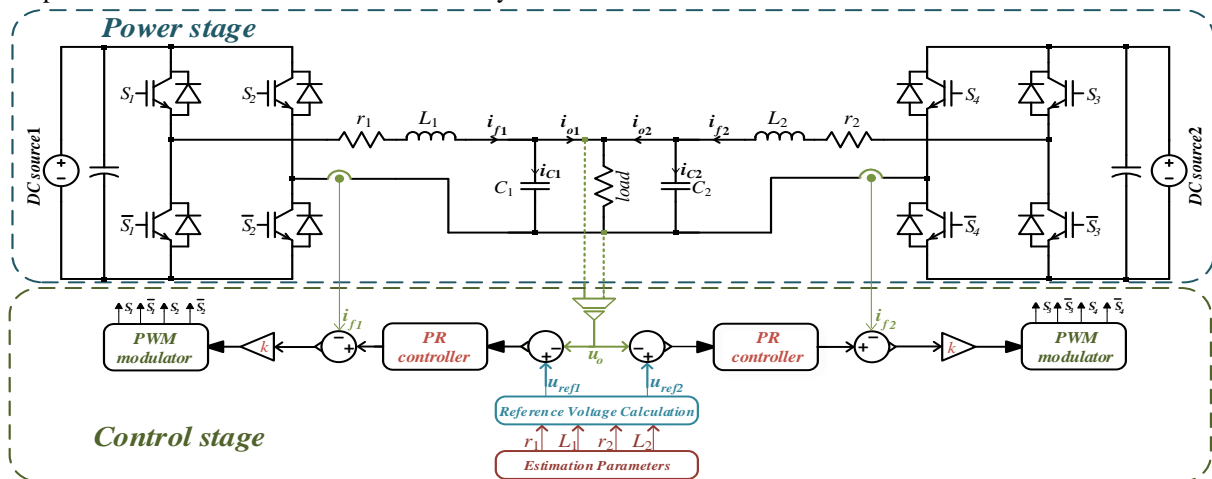

Fig. 1. Model of parallel inverters

The main purpose of this paper is to exactly determine the output filter impedances. Knowing the exact values of filter impedances, a control algorithm is proposed to attain proper load sharing among parallel inverters. Also this strategy does not require communication lines with high bandwidth and a PLL.

Moreover, system has a high modularity, and as a result, if a defect occurs in any of inverters the rest of them continue working, therefore, the reliability of system will be increased. Transient and steady-state performances are well improved by employing the double loop control as outer voltage and inner current control. This paper is organized as follows. The model of parallel inverters and the proposed control algorithm are presented in section 2. In section 3 the filter parameter estimation algorithm is investigated. For evaluation of the proposed control and estimation algorithms, simulation results are reported in section 4. The paper is concluded in section 5.

## 2. Parallel Inverters Modeling and Control

The model of two single phase inverter in parallel operation via controller is shown in Fig.1. In the power stage, the output of each inverter is connected to common load at the point of common coupling (PCC) via smoothing LC type filter. Any types of load such as resistive, inductive, capacitive, linear or nonlinear can be connected to PCC. Each of inverters is supplied from isolated DC source. Reference voltage calculation and estimation parameter are two major part for proper current sharing among parallel inverters in control stage. The purpose of part 1 is producing proper reference voltage for each inverter when the inverter output impedance is not clear. Equivalent output filter impedance can change at working operation, thus, this impedance is not clear. These changes may affect the performance of parallel inverters and lead to creation of circulating current among them. Therefore, with parameters

estimations that is the aim of part 2, the influence of above impact will be reduced and proper system operation is guaranteed. Finally, Proportional-Resonant (PR) controller is used to stabilize the transient and steady state operation. In the following, proposed algorithm for generated reference voltage of each inverter is investigated. The equivalent circuit of two parallel inverters is shown in Fig.2.

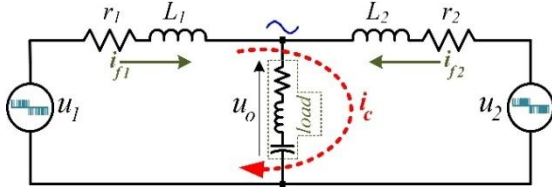

Fig. 2. Equivalent circuit of parallel inverters

According to Fig.2, open circuit voltage of each inverter can be calculated through this equation:

$$\begin{cases} u_1 = u_o + \Delta v_1 \\ u_2 = u_o + \Delta v_2 \end{cases} \quad (1)$$

where  $u_{1,2}$ ,  $\Delta v_{1,2}$  and  $u_o$  are open circuit voltage, drop the voltage on filter impedances and the output voltage of inverter 1,2 respectively. Drop voltage on equivalent filter impedance of each inverter described as follows.

$$\begin{cases} \Delta v_1 = r_1 i_{f1} + L_1 \frac{di_{f1}}{dt} \\ \Delta v_2 = r_2 i_{f2} + L_2 \frac{di_{f2}}{dt} \end{cases} \quad (2)$$

where  $i_{f1,2}$ ,  $L_{1,2}$  and  $r_{1,2}$  are filter current, filter inductance and resistance of inverter 1,2 respectively. With assuming  $u_o$  as a reference voltage for two inverters and determination of drop voltage on filter impedance, proper open circuit voltage for each inverters can be calculated. As a result, achieve to proper load sharing among parallel inverters. Derivative of filter current at s-domain is  $sI_f(s) - I_f(0)$ . But in practical application to prevent noise amplification and non-minimum phase system, derivative is used in conjunction with an integrator. Assuming zero initial conditions and with consideration of mentioned points the derivative is described as follows:

$$G_d(s) = \frac{s}{Ts + 1} \quad (3)$$

where  $T$  should be chosen small enough to decrease the effect of pole  $s = -1/T$ . Due to discrete nature of power electronics implementation, therefore must be used z-domain instead of s-

domain. As a result, all equations are transferred from s-domain to z-domain according to:

$$z = e^{sT_s} = \frac{1 + sT_s/2}{1 - sT_s/2} \quad (4)$$

where  $T_s$  is the sampling period, which is considered to be the same as the switching period. Then for digital implementation of derivative operation on the filter current, (4) is replaced into (3), as a result:

$$\frac{2(z-1)}{z(2T+T_s) + (T_s-2T)} i_f(z) \quad (5)$$

By replacing (5) in (2) the voltage drop on the equivalent filter impedance is calculated as:

$$\begin{cases} \Delta v_1(z) = r_1 i_{f1}(z) + L_1 i_{f1}(z) \frac{2(z-1)}{z(2T+T_s) + (T_s-2T)} \\ \Delta v_2(z) = r_2 i_{f2}(z) + L_2 i_{f2}(z) \frac{2(z-1)}{z(2T+T_s) + (T_s-2T)} \end{cases} \quad (6)$$

According to (1) and (6) and  $u_o$  which is equal to the reference voltage, open circuit voltages of two inverters are calculated as bellow:

$$u_1(z) = u_{ref}(z) + r_1 i_{f1}(z) + L_1 i_{f1}(z) \frac{2(z-1)}{z(2T+T_s) + (T_s-2T)} \quad (7)$$

$$u_2(z) = u_{ref}(z) + r_2 i_{f2}(z) + L_2 i_{f2}(z) \frac{2(z-1)}{z(2T+T_s) + (T_s-2T)} \quad (8)$$

The error between the open circuit voltages that is produced from (7), (8) and output voltage, is sent to their controller and modulator to generate proper gating pulse signals. But the calculation of open circuit voltage is dependent on the filter impedances and therefore to achieve proper current sharing among parallel inverters, the output current of two inverters must be the same, in spite of differences in the output filter impedances. Based on Fig. 1, the output current of each inverter is calculated as:

$$\begin{cases} i_{o1} = i_{f1} - i_{C1} \\ i_{o2} = i_{f2} - i_{C2} \end{cases} \quad (9)$$

where  $i_{o1,2}$  and  $i_{C1,2}$  are output and capacitance currents of inverters 1,2, respectively. With the same power level, filter capacitance of all inverters is equal together and with the same output voltage for them, capacitor currents are also the same and they can be assumed equal. As a result, if the filter currents of two inverters ( $i_{f1,2}$ ) are equal, then one can say that the proper load sharing among parallel inverters is achieved. However, under working conditions due to the thermal effects and nonlinearity of magnetic cores, there is a possibility of variation in filter impedance characteristics. If calculating of these

variations not correctly can lead to flow circulating current among parallel inverters. This current shown in Fig.2 by red line and its value calculated as follow equation:

$$i_{cir} = \frac{i_{f1} - i_{f2}}{2} \quad (10)$$

If filter current of two inverters equal together circulating current is equal to zero, but according to (2) and with the same filter current for two inverters, unequal voltage drops can occur. Hence the voltage drop must be calculated correctly. For this reason, estimation of filter parameters is proposed to find the exact values of filter parameters and thus the voltage drops are calculated correctly. In the next section, the proposed estimation algorithm is described.

### 3. Filter Parameters Estimation

Up to now various estimation methods have been proposed, however the recursive least squares (RLS) is the more attractive technique for both researchers and industry. The relation of RLS method is described as:

$$\begin{cases} \theta_{est}(t) = \theta_{est}(t-1) + p(t)\varphi(t)\varepsilon(t) \\ P(t) = p(t-1) - \\ \quad p(t-1)\varphi(t)(I + \varphi^T(t)p(t-1)\varphi(t))^{-1}\varphi^T(t)p(t-1) \\ \varepsilon(t) = y(t) - \varphi^T(t)\theta_{est}(t-1) \end{cases} \quad (11)$$

where  $\theta_{est}$ ,  $p(t)$ ,  $\varphi(t)$ ,  $\varepsilon(t)$  and  $y(t)$  are estimated parameters matrix, covariance matrix, regressor vector, prediction error and observable variable, respectively. Based on Fig. 2, the open circuit voltage of the inverter is used in the estimation method, which can be written as:

$$u(t) = ri_f(t) + L \left( \frac{i_f(t+1) - i_f(t)}{T_s} \right) + u_o(t) \quad (12)$$

Using (12) and combining it with (11) results in:

$$\begin{aligned} \varphi^T(t) &= [i(t) \quad u(t) - u_o(t)] \\ y(t) &= i(t+1) \\ \theta_{est}(t) &= \begin{bmatrix} 1 - \frac{rT_s}{L} \\ \frac{T_s}{L} \end{bmatrix} \end{aligned} \quad (13)$$

Based on above equation can be calculated filter parameters and use their values for computing of reference voltage for each inverter.

### 4. Performance Evaluation

To confirm the performance of the proposed control, simulation results in PLECS with the parameters of Table 1 are presented here. To ensure a fast and accurate control performance the

double loop control with the outer voltage and the inner current loops is used.

Table.1.  
System parameters

parameters	symbol	value
AC bus voltage	$V_{AC}$	110V RMS
DC Link	$V_{DC}$	170V
Filter resistance1,2	$r_{1,2}$	0.03 $\Omega$
Filter inductance1,2	$L_{1,2}$	0.6 mH
Filter capacitance1,2	$C_{f1,2}$	40 $\mu$ F
Load resistance	$R_o$	4 $\Omega$
output frequency	$f_o$	60 Hz
Switching frequency	$f_{sw}$	20 kHz

The current controller is a simple proportional (P) controller and to achieve a fast dynamic response without degrading the overall system stability, the gain of P is chosen as high as possible, here around 3. The proportional-resonant (PR) controller is used to accurately track the output voltage reference. Because of its very high gain at the fundamental frequency of the reference voltage, a zero tracking error is almost possible. In the PR controller, the proportional and integral coefficients are selected as 0.15 and 120, respectively. According to above values, the phase margin of the system is about 70 degrees, which is a recommended value for most power electronic converters. Both steady-state and transient operations are studied. In the steady-state, different loads such as resistive, inductive and a nonlinear load are connected to PCC. Simulation results of these loads are shown in Fig. 3, Fig. 4 and Fig. 5, respectively. In these figures the PCC voltage, inverters' currents, the circulating current and the total harmonic distortions (THDs) are displayed. Evidently, the performance of the load sharing technique between the two parallel inverters is satisfactory, consequently the load current is equally shared between the inverters and the circulating current is almost negligible. The circulating current under all loading conditions is less than 2 percent of the total load current. Also the harmonic spectrums, especially with a highly nonlinear load, reveal that the harmonic currents are also properly shared. Comparing the filter parameters in Table 1 with estimation results in Fig. 6, it is clear that the calculation error is less than 3%.

Inverter load changes consequently, thus the possibility of sudden and significant changes must be considered. Under this circumstance load sharing between parallel inverters must operate precisely and system remains stable. Figs. 7 and 8 depict simulation results for load step jump and step fall respectively. In these states after 3 sec load changes suddenly. As it is clearly shown in Figs. 8 and 9, controller has a fast and smooth

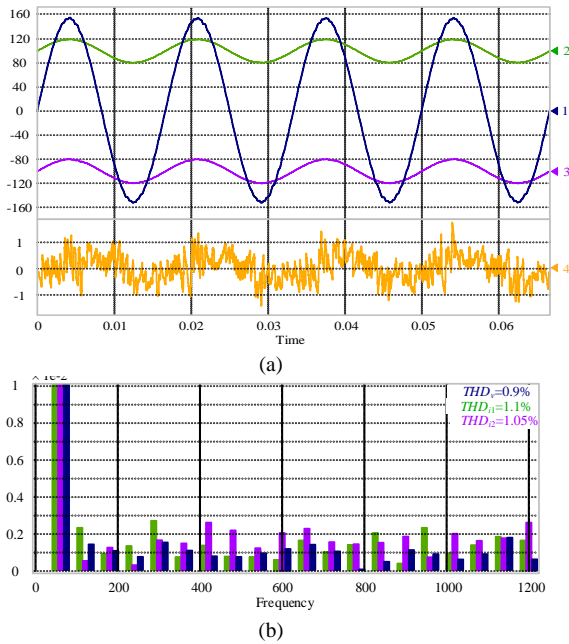

Fig. 3. (a):(ch1) PCC voltage, (ch2, 3) inverters' currents, (ch4) circulating current under inductive-resistive load and (b): harmonic spectrum and THD.

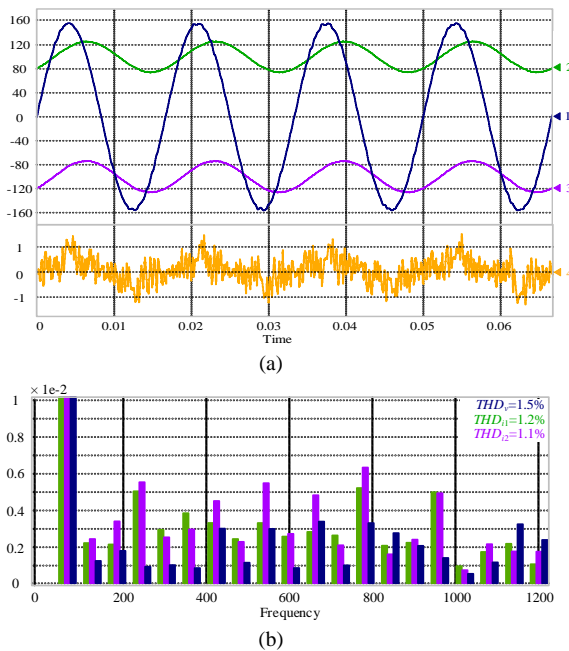

Fig. 4. (a): (ch1) PCC voltage, (ch2, 3) inverters' currents, (ch4) circulating current under nonlinear load and (b): harmonic spectrum and THD.

response and PCC voltage recovers in less than a cycle. Also the load sharing following the transient state is well done, which indicates that the proposed method has a robust transient performance.

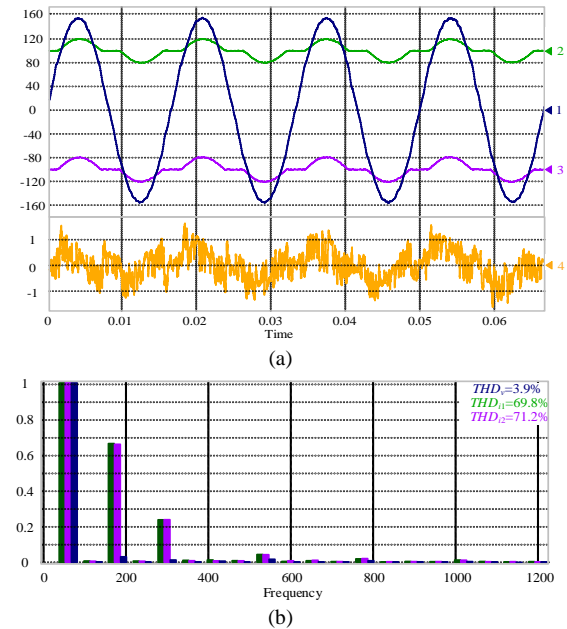

Fig. 5. (a): (ch1) PCC voltage, (ch2, 3) inverters' currents, (ch4) circulating current under nonlinear load and (b): harmonic spectrum and THD.

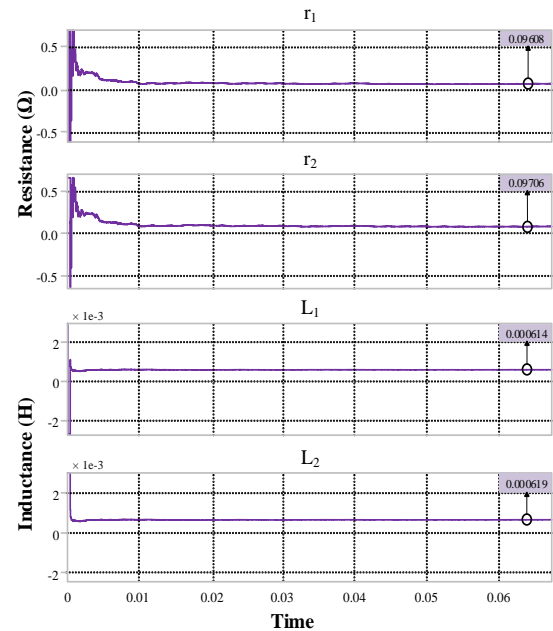

Fig. 6. Results of parameters estimation

### 5. Conclusion

In this paper, a formulation for reference voltages of parallel connected inverters to eliminate the circulating current was derived. Then, as a result of the reference voltage dependence on the filter parameters, a filter impedance estimation algorithm was proposed. Finally, simulation results in both steady-state and transient modes was presented that confirmed the proper operation of the proposed control and estimation techniques.



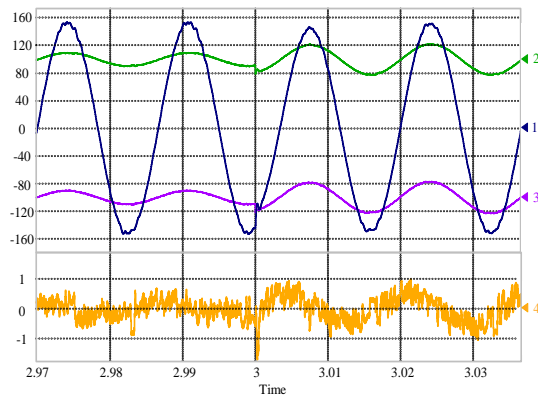

Fig. 7. (ch1) PCC voltage, (ch2, 3) inverters' currents, (ch4) circulating current in response to step load jump

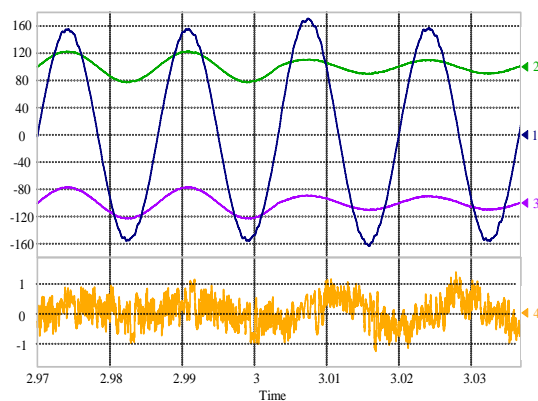

Fig. 8. (ch1) PCC voltage, (ch2, 3) inverters' currents, (ch4) circulating current in response to step load fall

## References

- [1] H. Han, X. Hou, J. Yang, J. Wu, M. Su, and J. M. Guerrero, "Review of power sharing control strategies for islanding operation of AC microgrids," *IEEE Trans. Smart Grid*, vol. 7, no. 1, pp. 200–215, 2016.
- [2] M. Zhang, Z. Du, X. Lin, and J. Chen, "Control Strategy Design and Parameter Selection for Suppressing Circulating Current Among SSTs in Parallel," *IEEE Trans. Smart Grid*, pp. 1–8, 2015.
- [3] W. Yao, M. Chen, J. Matas, J. M. Guerrero, and Z.-M. Qian, "Design and Analysis of the Droop Control Method for Parallel Inverters Considering the Impact of the Complex Impedance on the Power Sharing," *IEEE Trans. Ind. Electron.*, vol. 58, no. 2, pp. 576–588, Feb. 2011.
- [4] M. Yu et al., "A novel decoupled current-sharing scheme based on circulating-impedance in parallel multi-inverter system," *IECON Proc. (Industrial Electron. Conf.)*, pp. 1668–1672, 2007.
- [5] C. Song, R. Zhao, Z. Zeng, M. Zhu, and H. Cai, "Circulating current elimination scheme for parallel operation of common dc bus inverters," *Int. J. Electr. Power Energy Syst.*, vol. 63, pp. 17–29, 2014.
- [6] J. M. Guerrero, J. C. Vásquez, J. Matas, M. Castilla, and L. García de Vicuña, "Control strategy for flexible microgrid based on parallel line-interactive UPS systems," *IEEE Trans. Ind. Electron.*, vol. 56, no. 3, pp. 726–736, 2009.
- [7] J. M. Guerrero, L. G. De Vicuña, J. Matas, J. Miret, and M. Castilla, "Output impedance design of parallel-connected UPS inverters," *IEEE Int. Symp. Ind. Electron.*, vol. 2, no. 4, pp. 1123–1128, 2004.
- [8] J. He and Y. W. Li, "An enhanced microgrid load demand sharing strategy," *IEEE Trans. Power Electron.*, vol. 27, no. 9, pp. 3984–3995, 2012.
- [9] D. Shanxu, M. Yu, and X. Jian, "Parallel operation control technique of voltage source inverters in UPS," *Proc. IEEE 1999 Int. Conf. Power Electron. Drive Syst.*, no. July, pp. 883–887 vol.2, 1999.
- [10] K. Siri, C. Q. Lee, and T.-F. Wu, "Current distribution control for parallel connected converters. II," *IEEE Trans. Aerosp. Electron. Syst.*, vol. 28, no. 3, pp. 841–851, Jul. 1992.
- [11] M. Prodanovic, "A survey of control methods for three-phase inverters in parallel connection," in *8th International Conference on Power Electronics and Variable Speed Drives*, vol. 2000, no. 475, pp. 472–477, 2000.
- [12] T.-F. Wu, K. Siri, and J. Banda, "The central-limit control and impact of cable resistance in current distribution for parallel-connected DC-DC converters," in *Proceedings of 1994 Power Electronics Specialist Conference - PESC'94*, pp. 694–702, 1994.
- [13] K. Piboonwattanakit and W. Khan-ngern, "Design of the Two Parallel Inverter Modules by Circular Chain Control Technique," in *2007 7th International Conference on Power Electronics and Drive Systems*, pp. 1518–1522, 2007.
- [14] Wu Tsai-Fu and Y. K. Chen, "3C strategy for inverters in parallel operation achieving an equal current distribution," *IEEE Trans. Ind. Electron.*, vol. 47, no. 2, pp. 273–281, 2000.
- [15] Yunqing Pei, Guibin Jiang, Xu Yang, and Zhaoan Wang, "Auto-master-slave control technique of parallel inverters in distributed AC power systems and UPS," in *2004 IEEE 35th Annual Power Electronics Specialists Conference (IEEE Cat. No.04CH37551)*, vol. 3, pp. 2050–2053, 2004.
- [16] K. Siri, "Current Distribution Control For Parallel Connected Converters: Part I," *IEEE Trans. Aerosp. Electron. Syst.*, vol. 28, no. 3, 1992.
- [17] Jingtao Tan, Hua Lin, Jun Zhang, and Jianping Ying, "A novel load sharing control technique for paralleled inverters," in *IEEE 34th Annual Conference on Power Electronics Specialist, 2003. PESC '03.*, vol. 3, pp. 1432–1437, 2003.
- [18] X. Sun, Y. S. Lee, and D. Xu, "Modeling, analysis, and implementation of parallel multi-inverter systems with instantaneous average-current-sharing scheme," *IEEE Trans. Power Electron.*, vol. 18, no. 3, pp. 844–856, 2003.
- [19] A. Bidram, A. Davoudi, and F. L. Lewis, "A Multiobjective Distributed Control Framework for Islanded AC Microgrids," *IEEE Trans. Ind. Informatics*, vol. 10, no. 3, pp. 1785–1798, Aug. 2014.