



Application of TRIZ Thinking Method to Unified Power Flow Controllers by Converting into DPFC and FSO-DPFC

Arash Hakimi-Tehrani^{1,2}, Jawad Faiz³, Ghazanfar Shahgholian^{1,2}

¹Department of Electrical Engineering, Najafabad Branch, Islamic Azad University, Najafabad, Iran, arash.hakimy@gmail.com

²Smart Microgrid Research Center, Najafabad Branch, Islamic Azad University, Najafabad, Iran, shahgholian@iaun.ac.ir

³School of Electrical and Computer Engineering, College of Engineering, University of Tehran, Tehran, Iran, jfaiz@ut.ac.ir

Abstract

This paper introduces an innovative and creative systematic thinking method based on TRIZ thinking technique which can improve the performance of unified power flow controllers (UPFC). This new device is called distributed power flow controller (DPFC). The difference between UPFC and DPFC lies in exchanging three-phase series converter with single-phase converters that are distributed along the transmission line. This is based on one of the 40 principles of TRIZ innovative thinking technique, called segmentation. The basic changes, occurring in the DPFC, compared to UPFC are eliminating common DC-link between the series and shunt converters, and replacing three-phase series converters with single-phase series converter. These changes, lead to more economic and more reliable system. Similar to UPFC, the DPFC adjusts line impedance, transmission angle and bus voltage simultaneously. The DPFC design procedure based on differences with UPFC is described and DPFC advantages in mitigation of transmission line voltage sag and fluctuation are shown; while in some cases, simulation results of using UPFCs, DSTATCOM, TCSC and SVC indicate voltage sags. Finally, this paper introduces one innovatively DPFC called fuzzy self-organized DPFC (FSO-DPFC) to solve the most important problem of DPFC. DPFC series converter with and without FSO controller (FSO-DPFC) are simulated. The simulation results of using FSO-DPFC, compared to traditional DPFC, shows more system ability to mitigate disturbances in the central controller signals.

Keywords: TRIZ Technique, FACTS, DPFC, FSO-DPFC, Fuzzy Self Organized, UPFC, Series Converter, Shunt Converter

Article history: Received 2023/06/16; Revised 2023/08/20; Accepted 2023/09/16. Article Type: Research paper

© 2024 IAUCTB-IJSEE Science. All rights reserved

<https://doi.org/10.30495/ijsee.2022.1965676.1222>

1. Introduction

Electrical energy demand rising and transmission lines aging increase the importance of power flow control [1,2]. It is necessary to take into account both economical and power environmental issues in establishing any power system [3,4]. It is essential to review traditional methods and create new concepts emphasizing more efficient use of the already existing power system resources with no reduction in system stability and security [5,6]. Flexible ac transmission system (FACTS) devices can effectively control the electrical power flow [7,8]. There are many kinds of FACTS devices operating based on the line specifications [9,10] which enhance transmission capacity and control power flow over designated transmission routes [11,12].

An approach for damping inter-area oscillations in a bulk power network using multiple UPFC

utilizing ultra-capacitors, also known more generally as electrochemical capacitors [13,14].

TRIZ technique is an innovative problem solving method containing 40 principles. It claims that most inventions and new works have one or more of 40 principles of TRIZ [15,16]. This technique has been used in various studies [17,18].

A study to identify 8 different appropriate TRIZ-based strategies for solar energy investment for commercial and non-commercial users is presented in [19], the main motivation of which is to determine the weights of solar energy investment strategies. The results show that mechanical system replacement is found to be the most effective TRIZ-based investment strategy for solar energy projects in both commercial and non-commercial aspects.

Dynamic voltage restorer (DVR) device is considered as a case of electrical engineering field in

[20] to investigate and develop a TRIZ-based guidance framework, which helps to solve the problems of DVR devices. The proposed sector specific guidelines in particular segment of electrical engineering will be closer, more comprehensible and particularly linked to key parameters of that sector.

This paper introduces distributed power flow controller (DPFC) according to segmentation principle of TRIZ thinking technique, which is more economic and reliable system compared to the traditional method. Furthermore, simulation results will show that the voltage sag in the DPFC is considerably decreased which is better than those presented in unified power flow controller (UPFC), TCSC and SVC. It is observed that there is about 30% voltage sag between 0.2 and 0.3 when UPFC is applied [21,22].

The most important contribution of this paper is innovatively using fuzzy self-organized controller (FSOC) on the DPFC called fuzzy self-organized distributed power flow controller (FSO-DPFC). The most important drawback of DPFC is its disability in providing proper response due to the large distance between the central controller and DPFC series converters. It means that there are disturbances in the control signals which must be mitigated. Because the series converters operate outdoors, the communication (wireless or PLC) between the central controller and series converters is susceptible to disturbances, such as lightning and geomagnetic storm. This paper has been organized as follows. Section 2 introduces the TRIZ technique and background of the systematic thinking method in DPFC and its merits. Section 3 proceeds to DPFC concept and in section 4 structure and calculation of optimal number of FSO-DPFC series units and FSOC are indicated. Section 5 presents the simulation results. Finally, section 6 concludes the paper.

2. Theory of inventive problem solving (TRIZ Technique)

TRIZ (Teoriya Resheniya Izobretatelskikh Zadatch) is the Russian abbreviation word which means "a problem solving, analysing and forecasting tool derived from the study of patterns of invention in the global patent literature" and its founder was Altshuller. In some cases, TRIZ is replaced by "the theory of inventive problem solving". This theory originates from the study of over 40,000 patent abstracts which results in contradiction matrix and 40 principles of invention which can innovatively solve the most problems. In other words, TRIZ is the worldwide theory of inventive problem solving, which can help the engineers to realize technology innovation [23,24]. The TRIZ technique has been shown in Fig. 1 [25,26].

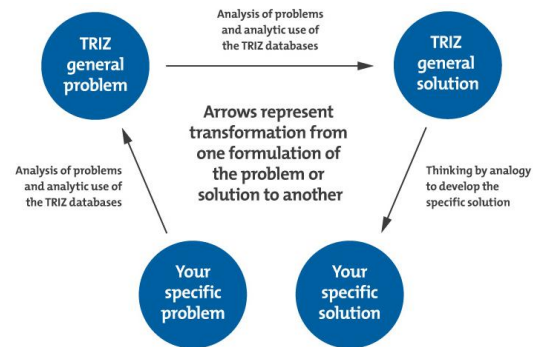

Fig. 1. TRIZ technique for problem solving

It is noted that the TRIZ technique in electrical engineering is converting the physical concepts of the TRIZ principles into electrical concepts. It is necessary to be familiar with both TRIZ and electrical engineering topics. For example, the concept of segmentation is converted into three-phase series converter requiring a large space compared to the multi single-phase series converters; the latter is distributed along the transmission line (no large space).

UPFC is one of the efficient FACTS devices, consisting of two important FACTS devices: STATCOM and SSSC [27,28]. This can be put in the combination principle group of the TRIZ principles. Applying combination principle to these two FACTS devices result in suitable features which is combination features of STATCOM and SSSC. It controls both the active and reactive power flow in the transmission line simultaneously and independently. Utilization of UPFC can result in significant reliability benefits in modern power systems [29,30].

They are one of the incomparable FACTS devices which actually have FACTS concept in three features of transmission system parameters controlling. They are voltage, impedance and phase-angle [31,32]. However, due to the reliability and cost issues, they have not been widely used in transmission lines. To solve this problem, a new FACTS device called DPFC has been recently introduced [33,34].

Since three-phase series converter has been replaced by a single-phase series converter in this structure, it was realized that the segmentation principle of the TRIZ principles has been used, where the advantages of this problem solving technique (TRIZ) is shown as follows:

A) Low cost: because of the lower voltage isolation and low rating of single-phase series converter compared to three-phase series converter.

B) Increasing flexibility: due to eliminating the common DC-link between the shunt and series

converters which provides independent placement of series and shunt converters.

C) Less space: due to optimal deployment where one shunt converter is placed in the previous position, there is no need for any space for UPFC three-phase series converter and single-phase converters are distributed along transmission line.

D) Increasing reliability: for series converter multiplicity because poly series converter is distributed along the line; if some of them fail to operate the remaining converters continue to operate.

3. DPFC concept

DPFCs and UPFCs have identical structure, and both have series and shunt controllers to control the voltage, impedance and phase angle [35,36]. To improve the UPFC and decrease its undesired features, the DPFC is proposed; some merits of DPFC in comparison with UPFC were mentioned in section, 2 [37,38]. Difference of UPFC and DPFC includes eliminating dc-link, distributing series converters along the transmission line and changing the controlling system. Based on these differences, it is preferred to consider the series converter of DPFC in details and other parts of DPFC in abstract [39,40].

A. Shunt converter of DPFC

The shunt converter shown in Fig. 2 is a three-phase converter connected to a single-phase converter. Structure and operation of these converters are similar to the STATCOM and shunt converter of the UPFCs [41,42]. To absorb active power of transmission line, the three-phase converter of the DPFC is connected to the Δ -side of the transformer in the DPFC shunt converter (similar to STATCOM), with fundamental frequency. The single-phase converter is located between the ground and neutral point of the Y- Δ transformer in order to inject the third-harmonic current into the grid [43,44].

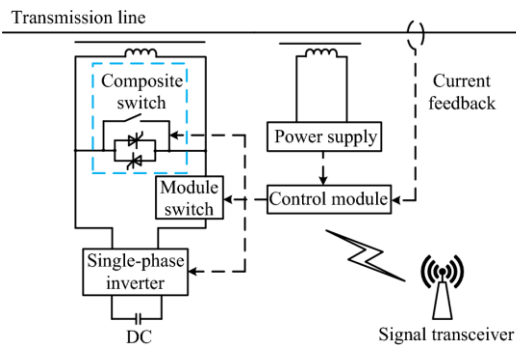

Fig. 2. Shunt converter

B. DPFC controller

To control the DPFC, it is divided into three segments including central, shunt and series controllers. The series converters have separable series controllers connected to the central controller for receiving the reference voltage. Series controller adjusts the DC voltage capacitor at fundamental frequency. Furthermore, fundamental frequency is used to inject series voltage to the transmission line by DPFC. The reason is that due to the large distance between the central controller and series converters, the control signal (V_d, V_q) disturbances are so probable; in fact the short come of the traditional DPFCs controller is its disability to match with these disturbances on the controller signal; so to overcome this problem the FSO-DPFC is designed and introduced, Which the central controller signal disturbances will not effect on the transmission voltage quality [45,46].

Central controller is used to generate reference voltage signal for series converters and reference current signal for shunt converter at the fundamental frequency. Shunt controller injects a constant third harmonic current into the line to supply active power to series converters. Similar to STATCOM, the power is controlled by a shunt compensator, by controlling voltage amplitude, reactive power exchange between the power flow controller and transmission line [47,48].

This paper focuses on the DPFC series converters and their control signals came from central controller. The reasons include importance of the series converter role in DPFCs and approximation of the other DPFC's elements with some of the FACTS devices such as UPFC and STATCOM.

4. Structure of DPFC series units

To control the line parameters, a shunt converter and some series converters with their controllers are used as shown in Fig. 3. One important factor in the design of DPFC is calculation of the number of series converters as described below.

A. Calculation of optimal number of series converters

Minimum number of series converters versus line parameters is calculated as follows [49]:

a) The total maximum ac voltage ($V_{se-f-max}$) injected by all series converters is as follows:

$$V_{se-f-max} = \frac{S_\gamma V_n}{X_f} \quad (1)$$

where X_f is the line impedance at the fundamental frequency, V_n is the nominal bus voltages and S_γ is the control range of power flow.

b) The maximum active power of all series converters (P_{se-max}) is obtained as follows:

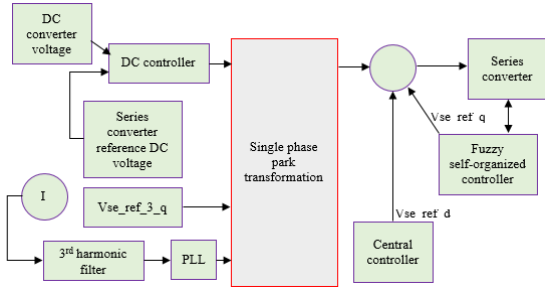

Fig. 3. Structure of series converter controller with FSO

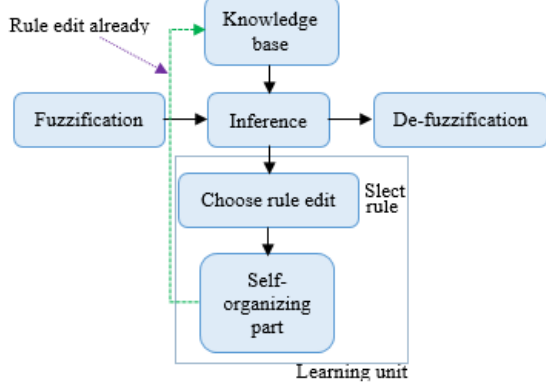

Fig. 4. Fuzzy self-organizing controller

$$P_{se-max} = \frac{|X_f| |S_{ro}|}{V_n^2} |S_\gamma| \quad (2)$$

where S_{ro} is the line power without the DPFC.

c) The maximum third harmonic voltage of series converter ($V_{se-3^{rd}-max}$) used for DC voltage stabilization;

$$|V_{se-3^{rd}-max}| = \frac{P_{se-max}}{I_3} \quad (3)$$

where I_3 is the magnitude of the third harmonic current calculated according to the thermal capacity of the neutral wire.

d) The maximum voltage and current of the converter is the summation of fundamental and third harmonic of voltage and current, as follows:

$$V_{se-max} = V_{se-f-max} + V_{se-3^{rd}-max} \quad (4)$$

$$I_{se-max} = I_{1-max} + I_3 \quad (5)$$

e) The ratio of winding turns of the series converters (T_{trans}) is as follows:

$$T_{trans} = \frac{I_{max}}{I_{MOS}} \quad (6)$$

Since the primary is a single turn (the 1st winding of transformer); I_{max} is the maximum line current and I_{MOS} is the maximum current of the proposed MOSFET.

f) Finally, the optimum number of the distributed series converters to transmission line N is as follows:

$$N = \sqrt{6} \frac{V_{se-max-trans}}{V_{MOS}} \quad (7)$$

where V_{MOS} is the maximum voltage of the proposed MOSFET. The FSO-DPFC series unit contains two basic elements, the series converter and series controller. One basic part of the series unit is FSO and basic input element of series converter controllers is the reference signal of the central controller. In order to improve the transmission line voltage, the controller sends the input signal to the series converter and series converter generates a suitable signal.

The series converter controller measures the line current. Then the third harmonic current in the PLL is used to determine the third harmonic current angle. The classic PLL consists of a voltage controlled oscillator (VCO) and phase compensator [50,51]. The PLL output is used as single-phase Park's transformation rotating reference frame and it is combined with d-component of DC controller output which is used with q-component of $V_{se-ref-3}$ (that considered constant value of zero) [52]. In the final step, the Park's transformation output has combined with $V_{se-ref-f}$ came from central controller, in order to send it to the series converter and improve the line voltage or decrease the voltage sag, harmonics and fluctuations. In the FSO-DPFC, there is a FSO in the series unit which is described in the following section.

B. Fuzzy self-organized controller

As shown in the Fig. 4, first the controller fuzzifies the input data, then the knowledge base rules are modified automatically. The new modified rules are chosen according to the input data, and the output is calculated; finally, de-fuzzification unit produces the output for the V_{se} unit leading to suitable series voltage [53,54]. According to the fuzzification input data, Table 1 with 49 updated rules forms the knowledge base giving the suitable value in each learning revolution. The self-organizing section uses the following equations for changing the rules in the knowledge base [55,56]:

Table 1

Knowledge base and rules at time n_T in learning revolution K								
	<i>de</i>	<i>NB</i>	<i>NM</i>	<i>NS</i>	<i>ZE</i>	<i>PS</i>	<i>PM</i>	<i>PB</i>
E	center	-0.6	-0.4	-0.2	0	0.2	0.4	0.6
NB	-0.6	-0.6	-0.6	-0.6	-0.6	-0.4	-0.2	0
NM	-0.4	-0.6	-0.6	-0.6	-0.4	-0.2	0	0.2
NS	-0.2	-0.6	-0.6	-0.4	-0.2	0	0.2	0.4
ZE	0	-0.6	-0.4	-0.2	0	0.2	0.4	0.6
PS	0.2	-0.4	-0.2	0	0.2	0.4	0.6	0.6
PM	0.4	-0.2	0	0.2	0.4	0.6	0.6	0.6
PB	0.6	0	0.2	0.4	0.6	0.6	0.6	0.6

$$E = \frac{1}{2}[y(t) - y_{sp}]^2 \quad (8)$$

$$\overline{c_L}(k+1) = \overline{c_L}(k) - \alpha \frac{\partial E}{\partial c_L} \quad (9)$$

In (9), $c_L(k)$ is the membership function of rule “L” at learning revolution of “k” and $C_L(k+1)$ is the membership function of rule “L” at learning revolution of “k+1”; α is the learning rate and $(\partial E/\partial c_L)$ is the differential function for comparing it with c_L calculated as follows:

$$\frac{\partial E}{\partial c_L} = \frac{\mu_L(e) \times \mu_L(ce) \times (y(t) - y_{sp})}{\sum_{L=1}^n (\mu_L(e) \times \mu_L(ce))} \quad (10)$$

where $\mu_L(e)$ is the membership level of rule “L” error, $\mu_L(ce)$ is the membership level of rule “L” changing error, y_{sp} is the required revolution value, and $y(t)$ is the measured revolution value. The learning rate is calculated as follows:

$$\alpha = \text{weight} \times |e(nT) - \overline{c_L}(nT)| \quad (11)$$

1. Because the measured performance value should be affected the learning rate and input changing on learning rate in every period of time. In (11), $e(nT)$ is the error at time nT , $c_L(nT)$ is the fuzzy singleton of output of rule “L” at time nT .

The performance value is the difference between the specific performance value and desired performance value described as follows:

$$\Delta OV = OV_{desired} - OV \quad (12)$$

Weighted value is the measured one with following conditions [57,58]:

If $\Delta OV < 0.3$ then weight is 0.0.

If $\Delta OV \geq 0.3$ and $\Delta OV \leq 0.1$ then weight is 1.0.

If $\Delta OV > 1.0$ and $\Delta OV \leq 3.0$ then weight is 3.0.

If $\Delta OV > 3.0$ then weight is 3.0; [59,60].

5. Simulation Results

Number of series converters per phase can be determined by substituting the appropriate values from Table 2.

Table 2
Values for sample calculation

Power (kW)	Voltage (V)	Reactance (Ω)	Current (A)
$S_r=1000$	$V_n=380$	$X_f=3$	$I_{MOS}=2$
$Q_0=500$	$V_{MOS}=230$	$X_3=3.0084$	$I_{max}=2$
$P_0=1000$		$f=50(\text{Hz})$	$I_{Thermal}=2.2$

According to the above values and (1) to (7), $N=1$ per phase, the number of series converter distributed along the line is 3, according to Table 3, there is economization, because of series capacitor bank, eliminating three-phase series converter transformer and replacing three-phase series converter with single-phase converters. The series converter elements have been simulated using Matlab/Simulink. As shown in Fig. 5, the DPFC and FSO-DPFC series unit are connected in series to the one phase of transmission line. Fig. 6 shows the FSO unit structure which operates as described in section 4, based on the combination of Matlab M-file programming and Simulink. Power system specification which has been used for simulation are shown in Table 4.

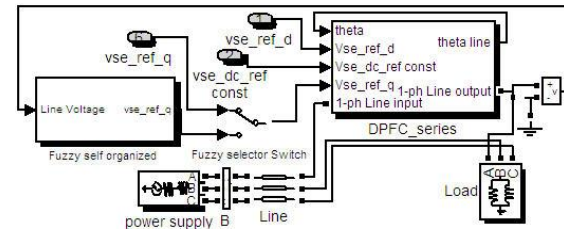

Fig. 5. Simulation of DPFC and FSO-DPFC series unit location on phase-A by Matlab/Simulink

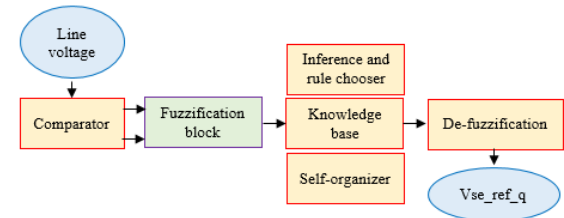

Fig. 6. FSO-DPFC fuzzy self-organized controller unit

Table 3
Comparison of elements in DPFC with UPFC

Components	DPFC	UPFC
Three-phase transformer for shunt converter	2	2
shunt converter	2 (1:3 phase+1: single phase for 3 rd harmonic)	1:3 phase
shunt capacitor bank	1	1
Three-phase transformer for series converter	0	2
series converter	3(single-phase)	1(3-ph)
series capacitor bank	0	1

The next inside layer of the DPFC series unit, shown in Fig. 7 contains the following inputs:

Series controller (contains PI and Integral controllers) needs a constant value for the reference of DC-controller of series converter which is, $V_{se_dc_ref}=0.5$.

The reference dq voltage of DPFC series converter (no FSO control) which used in dq components series converter generation have been shown in Fig. 8. The PLL needs the line current as an input, in order to calculate the angle for Park's inverse transformer. Finally, the Park's inverse transformer will generate the series converter voltage, in order to get into the phase-A voltage as shown in Fig. 9. The inputs, using in the DPFC series unit, the voltage will be improved. Fig. 10 shows the voltage, with much sag and fluctuation before using the DPFC series converters in phase-A. It, shows the improved voltage of phase-A with no fluctuation and harmonic, obtained using the DPFC series converter in phase-A.

As pointed-out in [61], the most important DPFC drawback is disturbance or communication failure, series converters may lose their synchronization with the grid, leading to power transmission failure. Accordingly, it is important to find a new method for determining a reliable means of communication between the central controller and the distributed series converters.

In Fig. 11 for showing the disturbance on the one of the central controller signals (V_d), comparing to Fig. 8, the V_d have been changed while V_q have been not changed. In Fig. 12 could see amplitude changes in step time of 0.2 sec and so could see a few voltage sags, because the system could not organize and adjust itself with disturbances of V_d signal.

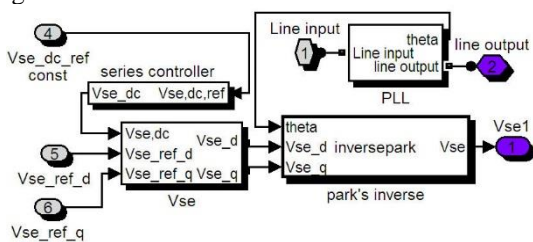

Fig. 7. Elements of FSO-DPFC series unit simulation by Matlab/Simulink

Table 4

Power system specification which has been used for simulation

Parameters	Volt.(ph-ph rms) (PU)	Freq. (HZ)	Additional description
Gen.(3-ph Source)	1(220V)	60	Angle= 3 degree
3-ph Load	1(220V)	60	Y(ground), P=10, Q _L =10 3-ph,
Line	-	60	0.386(ohm/Km), 4(mH/Km), 7(nF/Km), 100 (Km)

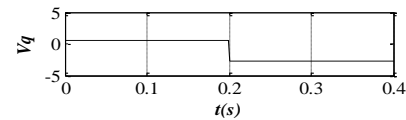
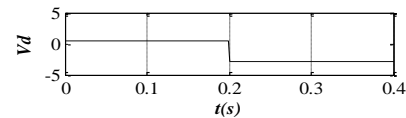

Fig. 8. dq reference voltages of series converter

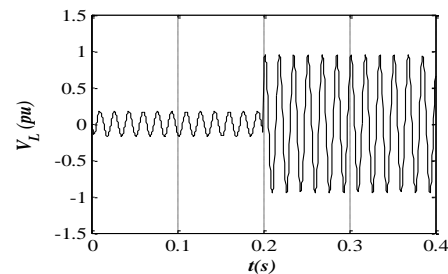

Fig. 9. Line voltage of phase-A before series converter

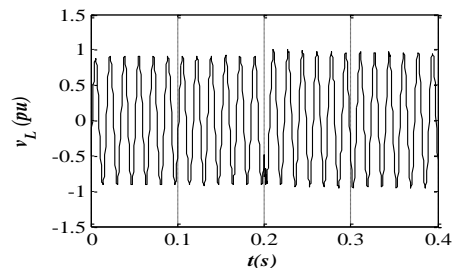

Fig. 10. Line voltage of phase-A, after using series converter

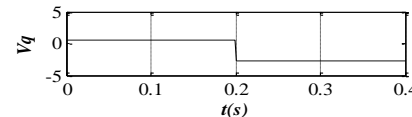
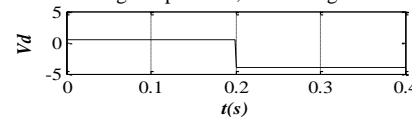

Fig. 11. Changing of the V_d traditional DPFC component (disturbance)

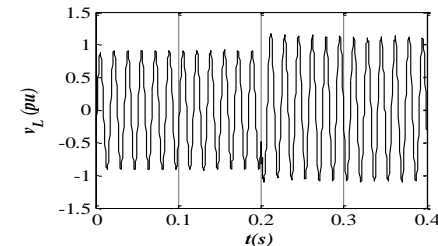

Fig. 12. Result of d components changing (disturbance) in DPFC

While as shown in Fig. 5, we have used FSO controller as a V_q control signal producer. Which FSO controller produce suitable V_q control signal according to line voltage and V_d to compensate V_d disturbances effects on transmission line voltage. So have been shown the V_d in Fig. 13 with same

properties of Fig. 8. In Fig. 15 the shown V_q component is the FSO controller output which applied in to the DPFC for V_q component. Fig. 14 shows the suitable line voltage response which is the result of using FSO-DPFC. Fig. 15 shows the V_d with same properties of Fig. 11. In Fig. 15 the shown V_q component is the FSO controller output which applied in to the DPFC for V_q component. Fig. 16 shows the suitable line voltage response which is the result of using FSO-DPFC. We couldn't see any amplitude changing and voltage sag in Fig. 16 opposite with Fig. 12, while V_d component in both cases (Fig. 11, Fig. 15) have the same properties and comparing to Figs. 8 and 13 because of system error or disturbance, the V_d control signal amplitude have been changed. This segment shows that the line voltage improves using the DPFC series converter which is the segmentation TRIZ technique and FSO-DPFC improves the traditional DPFC in cases which control signal has disturbance.

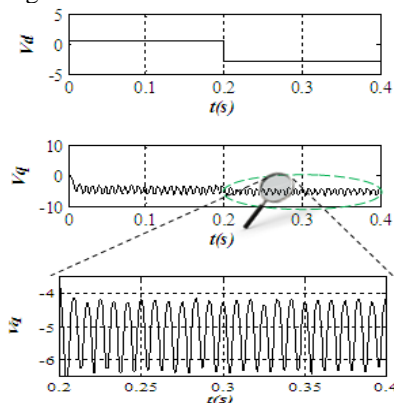

Fig. 13. V_d , V_q components of FSO-DPFC

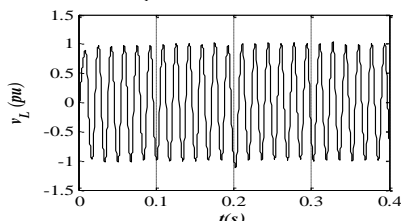

Fig. 14. Line voltage by using the FSO-DPFC and V_d signal

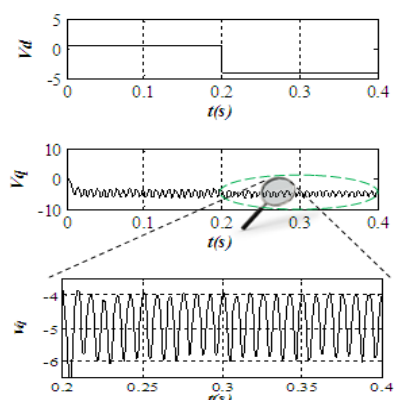

Fig. 15. V_d , V_q components of FSO-DPFC

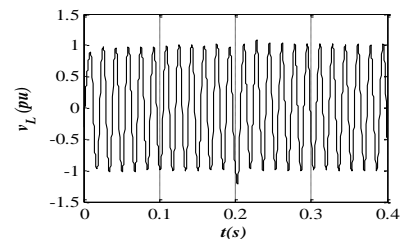

Fig. 16. Line voltage by using the FSO-DPFC while V_d component of control signal have been had disturbance

6. Conclusion

This paper presented the thinking background behind the DPFC design by using TRIZ "segmentation" principle method. It was shown using TRIZ principle in the UPFC has some advantages in DPFC compared to UPFC. These included decreasing converters location space, lower the cost and increase the reliability and flexibility of the system.

The most important problem in traditional DPFCs is disability of system to provide suitable response where there are some disturbances in the control signals; accordingly, by changing the V_d of central control (as a central control signal disturbance), could see changes in simulation results. While by using the innovatively fuzzy self-organized controller in the DPFC can overcome to this problem and get the suitable response without the central control disturbances effects on the transmission line voltage (V_L).

References

- [1] M.J. Abdollahifard, M.R. Mehrdad, "A machine vision based approach for sag measurement in power lines", Journal of Intelligent Procedures in Electrical Technology, vol. 14, no. 55, pp. 101-116, Autumn 2023, dor: 20.1001.1.232-23871.1402.14.55.8.6
- [2] S. Gorji, S. Zamanian, M. Moazzami, "Techno-economic and environmental base approach for optimal energy management of microgrids using crow search algorithm", Journal of Intelligent Procedures in Electrical Technology, vol. 11, no. 43, pp. 49-68, Oct. 2020, dor: 20.1001.1.23223-871.1399.11.43.4.7.
- [3] G. S. Chawda, A. G. Shaik, O. P. Mahela, S. Padmanaban, J. B. Holm-Nielsen, "Comprehensive review of distributed FACTS control algorithms for power quality enhancement in utility grid with renewable energy penetration", IEEE Access, vol. 8, pp. 107614-107634, 2020, doi: 10.1109/ACCESS.2020.3000931.
- [4] Y. Chen, R. Moreno, G. Strbac and D. Alvarado, "Coordination strategies for securing AC/DC flexible transmission networks with renewables", IEEE Trans. on Power Systems, vol. 33, no. 6, pp. 6309-6320, Nov. 2018, doi: 10.1109/TPWRS.2018.2851214.
- [5] S. Bruno, G. D. Carne, M. L. Scala, "Distributed FACTS for power system transient stability control", ENERGIES, vol. 13, no. 11, Article: 2901, pp. 1-16, June 2020, doi: 10.3390/en13112901.
- [6] O. Gomis-Bellmunt, J. Sau-Bassols, E. Prieto-Araujo and M. Cheah-Mane, "Flexible converters for meshed HVDC grids: From flexible ac transmission systems (FACTS) to flexible DC grids", IEEE Trans. on Power Delivery, vol. 35,

- no. 1, pp. 2-15, Feb. 2020, doi: 10.1109/TPWRD.2019.29-39588.
- [7] Y. Chen, R. Moreno, G. Strbac and D. Alvarado, "Coordination strategies for securing AC/DC flexible transmission networks with renewables", *IEEE Trans. on Power Systems*, vol. 33, no. 6, pp. 6309-6320, Nov. 2018, doi: 10.1109/TPWRS.2018.2851214.
- [8] B.B. Adetokun, C.M. Muriithi, "Application and control of flexible alternating current transmission system devices for voltage stability enhancement of renewable-integrated power grid: A comprehensive review", *Heliyon*, vol. 7, no. 3, Article Number: e06461, 2021, doi: 10.1016/j.heliyon.2021.e06461.
- [9] G. Shahgholian, H. Hamidpour, A. Movahedi, "Transient stability promotion by FACTS controller based on adaptive inertia weight particle swarm optimization method", *Advances in Electrical and Electronic Engineering*, Vol. 16, No. 1, pp. 57-70, March 2018, doi: 10.15598/aee.v16i1.2-369.
- [10] A.K. Singh, B.C. Pal, "Chapter 1- Introduction", *Dynamic Estimation and Control of Power Systems*, Academic Press, pp. 1-8, 2019, doi: 10.1016/B978-0-12-814005-5.00012-1.
- [11] A.A. Sadiq, M. Buhari, S.S. Adamu, H. Musa, "Coordination of multi-type FACTS for available transfer capability enhancement using PI-PSO", *IET Generation, Transmission and Distribution*, vol. 14, no. 21, pp. 4866-4877, Feb. 2020, doi: 10.1049/iet-gtd.2020.0886.
- [12] A. Hamidi, S. Golshannavaz, D. Nazarpour, "D-FACTS cooperation in renewable integrated microgrids: A linear multiobjective approach", *IEEE Trans. on Sustainable Energy*, vol. 10, no. 1, pp. 355-363, Jan. 2019, doi: 10.1109/TSTE.2017.2723163.
- [13] M. Zarghami, M.L. Crow, J. Sarangapani, Y. Liu, S. Atcity, "A novel approach to interarea oscillation damping by unified power flow controllers utilizing ultracapacitors", *IEEE Trans. on Power Systems*, vol. 25, no. 1, pp. 404-412, Feb. 2010, doi: 10.1109/TPWRS.2009.2036703.
- [14] B. Li, G. Xiao, R. Lu, R. Deng, H. Bao, "On feasibility and limitations of detecting false data injection attacks on power grid state estimation using D-FACTS devices", *IEEE Trans. on Industrial Informatics*, vol. 16, no. 2, pp. 854-864, Feb. 2020, doi: 10.1109/TII.2019.2922215.
- [15] S.J. Guang, T.R. Hua, W.W. Chao, "Research on inventive principles classification of electrical design: principles no.1 to no.20", *Journal of Engineering Design*, vol. 14, no. 1, pp. 91-99, April 2007.
- [16] F.Z.B. Moussa, I. Rasovska, S. Dubois, R.D. Guio, R. Benmoussa, "Reviewing the use of the theory of inventive problem solving (TRIZ) in green supply chain problems", *Journal of Cleaner Production*, vol. 142, pp. 2677-2692, 2017, doi: 10.1016/j.jclepro.2016.11.008.
- [17] A. Khodadadi, P. Buelow, "Design exploration by using a genetic algorithm and the theory of inventive problem solving (TRIZ)", *Automation in Construction*, vol. 141, Article Number: 104354, 2022, doi: 10.1016/j.autcon.2022.104354.
- [18] D.A.J. Pacheco, C.S. Caten, C.F. Jung, H.V.G. Navas, V.A. Cruz-Machado, L.M. Tonetto, "State of the art on the role of the theory of inventive problem solving in sustainable product-service systems: Past, present, and future", *Journal of Cleaner Production*, vol. 212, pp. 489-504, 2019, doi: 10.1016/j.jclepro.2018.11.289.
- [19] Y. Li, Z. Wu, H. Dinçer, H. Kalkavan, S. Yüksel, "Analyzing TRIZ-based strategic priorities of customer expectations for renewable energy investments with interval type-2 fuzzy modeling", *Energy Reports*, vol. 7, pp. 95-108, Nov. 2021, doi: 10.1016/j.egy.2020.11.167.
- [20] M. Mansoor, N. Mariun, A. Toudeshki, N.I.A. Wahab, M. Hojabri, "Innovating problem solving in power quality devices: A survey based on dynamic voltage restorer case (DVR)", *Renewable and Sustainable Energy Reviews*, April 2017, doi: 10.1016/j.rser.2016.12.022.
- [21] C. Rambabu, Y.P. Obulesu, C. Saibabu, "Improvement of voltage profile and reduce power system losses by using multi type FACTS devices", *International Journal of Computer Applications*, vol. 13, no. 2, pp. 37-42, Jan. 2011.
- [22] S. Muthukrishnan, A. Nirmalkumar, "Enhancement of power quality in 14 bus system using UPFC", *Res. Jou. Appl. Sci. Eng. Tec.*, Vol. 2, No. 4, pp. 356-361, 2010.
- [23] C.-T. Su, F.M. Su, "Yield improvement in color filter manufacturing using taguchi methods and TRIZ's substance-field analysis", *IEEE Trans. on Components, Packaging and Manufacturing Technology*, vol. 8, no. 12, pp. 2198-2212, Dec. 2018, doi: 10.1109/TCPMT.2018.28-46692.
- [24] J.C. Alvarez, K. Hatakeyama, M. Carvalho, R.C. Marçal, J. Inche, N. Melo, "A model for renewable energy-based product innovation based on TRIZ methodology, exergy analysis and knowledge management: Case study", *Energy Reports*, vol. 8, pp. 1107-1114, Nov. 2022, doi: 10.1016/j.egy.2022.07.110.
- [25] L. Li, M. Wang, Y. Liu, Y. Chang, "System fuzzy control and fault diagnosis technology based on TRIZ theory", *Advanced Materials Research*, vol. 219-220, no.1, pp. 275-278, 2011.
- [26] T. Zhang, X. Hui, P. Jiang, H. Zhang, "A method of technology roadmapping based on TRIZ", *Proceeding of the IEEE/ICMTT*, pp. 51-54, Singapore, June 2010, doi: 10.1109/ICMIT.2010.5492841.
- [27] Z. Moravej, M. Pazoki, M. Khederzadeh, "Impact of UPFC on power swing characteristic and distance relay behavior", *IEEE Trans. on Power Delivery*, vol. 29, no. 1, pp. 261-268, Feb. 2014, doi: 10.1109/TPWRD.2013.2270408.
- [28] T.A. Sivakumar, M. Mary Linda, "Improving the dynamic performance of grid connected wind farms using modern UPFC", *Microprocessors and Microsystems*, vol. 74, Article Number: 103015, April 2020, doi: 10.1016/j.micpro.2020.103015.
- [29] S.T. Kalyani, G.T. Das, "Simulation of real and reactive power flow control with UPFC connected to a transmission line", *Journal of Theoretical and Applied Information Technology*, vol. 4, no. 1, pp. 16-22, 2008.
- [30] J. Guo, M.L. Crow, J. Sarangapani, "An improved UPFC control for oscillation damping", *IEEE Trans. on Power Systems*, vol. 24, no. 1, pp. 288-296, Feb. 2009, doi: 10.1109/TPWRS.2008.2008676.
- [31] G. Shahgholian, J. Faiz, "Coordinated control of power system stabilizer and FACTS devices for dynamic performance enhancement- State of art ", *Proceeding of the IEEE/IEPS*, pp. 1-6, Kyiv, Ukraine, June 2016, doi: 10.1109/IEPS.2016.7521865.
- [32] A. Motaghi, M. Aalizadeh, M. Abbasian, "Reactive power compensation and reducing network transmission losses by optimal placement of parallel and series FACTS devices with fuzzy-evolutionary method", *Journal of Intelligent Procedures in Electrical Technology*, vol. 9, no. 35, pp. 27-38, December 2019, dor: 20.1001.1.23223871.1397.9.35.4-7.
- [33] R. Rajarajan, R. Prakash, "A reformed adaptive frequency passiveness control for unified power quality compensator with model parameter ability to improve power quality", *Microprocessors and Microsystems*, vol. 73, Article Num. 102984, 2020, doi: 10.1016/j.micpro.2019.102984.
- [34] M.E.A. Farrag, G. Putrus, "An on-line training radial basis function neural network for optimum operation of the UPFC", *European Transactions on Electrical Power*, vol. 21, no.1, pp. 27-39, Jan. 2011, doi: 10.1002/etep.409.
- [35] R. Pavan Kumar Naidu, S. Meikandasivam, "Power quality enhancement in a grid-connected hybrid system with coordinated PQ theory & fractional order PID controller in DPFC", *Sustainable Energy, Grids and Networks*, vol. 21, Article Number: 100317, March 2020, doi: 10.1016/j.segan.2020.100317.

- [36] Y. Zhang, G. Lu, W. A. Khan, Y. Zhang, Q. Zhu, "Direct power flow controller—A new concept in power transmission", *IEEE Trans. on Power Electronics*, vol. 35, no. 2, pp. 2067-2076, Feb. 2020, doi: 10.1109/TPEL.2019.2920423.
- [37] K. Peddakapu, M. R. Mohamed, M. H. Sulaiman, P. Srinivasarao, A.S.Veerendra, P. K. Leung, "Performance analysis of distributed power flow controller with ultra-capacitor for regulating the frequency deviations in restructured power system", *Journal of Energy Storage*, vol. 31, Article: 101676, Oct. 2020, doi: 10.1016/j.est.2020.101676.
- [38] A. Tang, Y. Shao, Q. Xu, X. Zheng, H. Zhao, D. Xu, "Multi-objective coordination control of distributed power flow controller", *CSEE Journal of Power and Energy Systems*, vol. 5, no. 3, pp. 348-354, Sept. 2019, doi: 10.17775/CSEEJPES.2018.01450.
- [39] Y. Zhang, M. Hong, E. Dall'Anese, S.V. Dhople, Z. Xu, "Distributed controllers seeking ac optimal power flow solutions using ADMM", *IEEE Trans. on Smart Grid*, vol. 9, no. 5, pp. 4525-4537, Sept. 2018, doi: 10.1109/TSG.2017.2662639.
- [40] A. Tang, Z. Lu, H. Yang, X. Zou, Y. Huang, X. Zheng, "Digital/analog simulation platform for distributed power flow controller based on ADPSS and dSPACE", *CSEE Journal of Power and Energy Systems*, vol. 7, no. 1, pp. 181-189, Jan. 2021, doi: 10.17775/CSEEJPES.2020.02210.
- [41] J. Dai, Y. Tang, Y. Liu, et al. "Optimal configuration of distributed power flow controller to enhance system loadability via mixed integer linear programming", *J. Mod. Power Syst. Clean Energy*, vol. 7, pp. 1484-1494, 2019, doi: 10.1007/s40565-019-0568-8.
- [42] F. Xu, X. Ni, M. Zheng, Q. Chen, P. Qiu, Y. Lu, "Comparison and analysis of distributed power flow controller technology", *Energy Reports*, vol. 8, no. 1, pp. 785-792, April 2022, doi: 10.1016/j.egyr.2021.11.074.
- [43] D.N. Rao, T. Surendra, S.T. Kalyani, "DPFC performance with the comparison of PI and ann controller", *International Journal of Electrical and Computer Engineering*, vol. 6, no. 5, pp. 2080-2087, Oct. 2016, doi: 10.11591/ijece.v6i5.
- [44] T. Aihong, Z. Wei, S. Jingen, Q. Peng, C. Qian, Z. Xiaohui, Y. Huiyuan, X. Binyu, "Optimal output power coordinated control strategy of distributed power flow controller", *International Journal of Electrical Power and Energy Systems*, vol. 140, Article Number: 108075, Sept. 2022, doi: 10.1016/j.ijepes.2022.108075.
- [45] Z. Yuan, S.W.H. Haan, J.B. Ferreira, D. Cvoric, "A FACTS device: Distributed power-flow controller (DPFC)", *IEEE Trans. on Power Electronics*, vol. 25, no. 10, pp. 2564-2572, Oct. 2010, doi: 10.1109/TPEL.2010.2050494.
- [46] T.E. Rao, E. Sundaram, S. Chenniappan, D. Almkhles, U. Subramaniam, M.S. Bhaskar, "Performance improvement of grid interfaced hybrid system using distributed power flow controller optimization techniques", *IEEE Access*, vol. 10, pp. 12742-12752, 2022, doi: 10.1109/ACCESS.2022.3146412.
- [47] G. Shahgholian, S. Eshthardiha, H. Mahdavinassab, M.R. Yousefi, "A novel approach in automatic control based on the genetic algorithm in STATCOM for improvement power system transient stability", *Proceeding of the IEEE/ICIS*, Vol. 1, pp.14-19, Varna, Sept. 2008, doi: 10.1109/IS.2008.4670419.
- [48] I.M. Martins, F.A. Silva, S.F. Pinto, I.E. Martins, "Sliding mode active and reactive power decoupled control for distributed power flow controllers", *Electric Power Systems Research*, vol. 112, pp. 65-73, July 2014, doi: 10.1016/j.epsr.2014.03.026.
- [49] Z. Yuan, S.W.H. Haan, B. Ferreira, "DPFC design procedure- A case study using the KEPCO UPFC as an example", *Proceeding of the IEEE/ECCE*, pp. 2696-2702, Sapporo, Japan, June 2010, doi: 10.1109/IPEC.2010.5542-343.
- [50] B. Chatterjee, B.N. Biswas, "Performance analysis of the 2nd order phase lock loop when phase modulation is added to the voltage controlled oscillator", *IETE Journal of Research*, vol. 56, no. 6, pp. 346-351, Jan. 2011.
- [51] J. Xu, H. Qian, S. Bian, Y. Hu, S. Xie, "Comparative study of single-phase phase-locked loops for grid-connected inverters under non-ideal grid conditions", *CSEE Journal of Power and Energy Systems*, vol. 8, no. 1, pp. 155-164, Jan. 2022, doi: 10.17775/CSEEJPES.2019.02390.
- [52] X. Zhu, M. Jin, X. Kong, J. Zhao, J. Liu, Q. Zhou, "Sub-synchronous resonance and its mitigation for power system with unified power flow controller", *Journal of Modern Power Systems and Clean Energy*, vol. 6, no. 1, pp. 181-189, Jan. 2018, doi: 10.1007/s40565-017-0283-2.
- [53] H.R. Patel, V.A. Shah, "Comparative analysis between two fuzzy variants of harmonic search algorithm: fuzzy fault tolerant control application", *IFAC-PapersOnLine*, vol. 55, no. 7, pp. 507-512, 2022, doi: 10.1016/j.ifacol.2022.07.494.
- [54] T.T. Huynh et al., "A new self-organizing fuzzy cerebellar model articulation controller for uncertain nonlinear systems using overlapped gaussian membership functions", *IEEE Trans. on Industrial Electronics*, vol. 67, no. 11, pp. 9671-9682, Nov. 2020, doi: 10.1109/TIE.2019.2952790.
- [55] Z.X. Wei, F. Doctor, Y.X. Liu, S.Z. Fan, J.S. Shieh, "An optimized type-2 self-organizing fuzzy logic controller applied in anesthesia for propofol dosing to regulate BIS", *IEEE Trans. on Fuzzy Systems*, vol. 28, no. 6, pp. 1062-1072, June 2020, doi: 10.1109/TFUZZ.2020.2969384.
- [56] G. Shahgholian, A. Hakimi, N. Behzadfar, "Motor speed maximum control in the resonance ratio controller for two-mass system using self-organizing fuzzy controller", *International Journal of Research Studies in Electrical and Electronics Engineering*, vol. 1, no. 6, pp. 1-8, 2020, doi: 10.20431/2454-9436.0601001.
- [57] P.K. Dash, S. Morris, S. Mishra, "Design of a nonlinear variable-gain fuzzy controller for FACTS devices", *IEEE Trans. on Control Systems Technology*, vol. 12, no. 3, pp. 428-438, May 2004, doi: 10.1109/TCST.2004.824332.
- [58] A. Shoulaie, M. Bayati-Poudeh, G. Shahgholian, "Damping torsional torques in turbine-generator shaft by novel PSS based on genetic algorithm and fuzzy logic", *Journal of Intelligent Procedures in Electrical Technology*, vol. 1, no. 2, pp. 3-10, Sept. 2010, dor: 20.1001.1.23223871.1389.1-2.1.2.
- [59] E. Hosseini, G. Shahgholian, H. Mahdavi-Nasab, F. Mesrinejad, "Variable speed wind turbine pitch angle control using three-term fuzzy controller", *International Journal of Smart Electrical Engineering*, vol. 11m no. 2, pp. 63-70, June 2022, dor: 20.1001.1.22519246.2022.11.02.2.0.
- [60] Y. Meng, H. Diñçer, S. Yüksel, "TRIZ-based green energy project evaluation using innovation life cycle and fuzzy modeling", *IEEE Access*, vol. 9, pp. 69609-69625, 2021, doi: 10.1109/ACCESS.2021.3077289.
- [61] I.L.S. Sheng, Kok-Soo, "Eco-efficient product design using theory of inventive problem solving (TRIZ) principles", *American Journal of Applied Sciences*, vol. 7, no. 6, pp. 852-858, 2010, doi: 10.3844/ajassp.2010.852.858.