



## **Selection of Optimal Size and Location of Distributed Generation (DG) Sources in the Power Grid According to the System Protection Settings in the Presence of Fault Current Limiters (FCL)**

**Ahmad Moradi <sup>1</sup>, Seyed Mahmoud Modaresi <sup>1\*</sup>, Parsa Servati <sup>1</sup>**

<sup>1</sup>Department of Electrical Engineering, Islamic Azad University South Tehran Branch, Tehran, Iran.

Received: 22-Jul-2022, Revised: 06-Aug-2022, Accepted: 09-Aug-2022.

### **Abstract**

Distributed generation resources are used to upgrade older power systems to more efficient systems. Although distributed generation resources have numerous benefits, they can cause protection problems due to multiple configurations. Fault current limiters (FCLs) are used to reduce short circuit current in the network. A change in short-circuit current can cause a change in the protection system settings. In this paper, using the genetic algorithm, the optimal size and location of distributed generation in the power network with the presence of FCL and without it according to the protection settings of the system have been studied. The results of this study were performed on the 33-bus IEEE network.

**Keywords:** Locating, DG, FCL, Power System Protection, Overcurrent Relay.

### **1. INTRODUCTION**

Smart grids allow us to access and respond better to a variety of network requirements. One of the major advantages of smart networks is the ability to be adjusted and designed with new network conditions and requirements [1-2]. However, the introduction of a new system

with coordinated device protection has opened a new stage in the field of smart grid protection studies. One of the inseparable and important components of smart grids is distributed product resources. Connecting distributed generation resources to the network can have significant effects on the distribution network. In particular, changes in the amount and direction of short-circuit current may cause malfunction of high current protection relays in the system.

---

\*Corresponding Authors Email:  
m\_modaresi@azad.ac.ir

Distributed generation sources have many advantages in the network, the main advantages of which are improving the voltage profile, reducing losses, and improving energy quality. But in addition to the mentioned advantages, distributed generation sources also have negative effects on the network, their biggest disadvantage is the creation of protection defects in the network, such as blinding of protection, the wrong trip of feeders, wrong trip of production units, unwanted islanding of a part of the network, prevention of automatic reopening, and asynchronous reopening, etc. DGs change some of the previous network indicators, such as different levels of error streams in different operating modes. The magnitude of these changes depends on several factors including network configuration, location of DGs, and size of fault current limiters (FCLs) [1-6].

Distributed generation sources (DG) connected to the power grid have many advantages, including reducing congestion in lines, optimal control of reactive power, power factor compensation, reducing emissions, increasing network efficiency, increasing energy efficiency, harmonic compensation, reducing active power losses, and improving the voltage profile. Fuel cells, photovoltaic arrays, energy storage sources, geothermal sources, and wind farms are examples of well-known DGs. Despite these advantages, DGs have adverse effects on the protection system and relay settings, which are caused by reverse power flow phenomena, due to the change in the direction of power flow or current and the increase in short-circuit power, which we

will discuss in detail later. There are consequences. These disadvantages will be related to their size, inherent characteristics, installation location, and connection type [7-8]. Many types of research have been done regarding the determination of coordination between overcurrent relays by mathematical calculations or experimental simulations. Most of the existing approaches deal with the radial and sometimes traditional distribution network using simple algorithms [9]. Many studies have been completed in the past to coordinate current pathways using conventional and computer-based methods, but most have completed this coordination without considering DG [10]. In the article [11], two limitation algorithms are proposed to optimize the capacity of wind turbines and solar cells in the conditions of connection to the main grid. Reference [12] proposes a protection scheme using directional overcurrent relays. This method is proposed to detect faults with a low short-circuit level that may occur due to the presence of distributed generation sources. The issue that needs to be considered in such methods is that modifying the protection plan by installing more switches for network zoning, reconfiguring the network, or changing protection equipment is very expensive. Also, the use of multiple protections in a specific area of the power system may make the protection coordination scenario more complicated and the analysis of events after they occur difficult. In [13], a resistive type fault current limiter is presented as an efficient solution to achieve maximum fault tolerance in wind turbines in different network faults. The protection coordination

of overcurrent relay based on a genetic algorithm (GA) is explained in [14]. GA is used to calculate the time setting factor and relay operation time with a certain time difference between them, taking into account the overall loading position and the local peak. In the proposed method, the GA algorithm is implemented for calculation in the settings of overcurrent relays, and then in each iteration, the time setting coefficient is determined using the LP method.

Fault current limiters are devices that are connected to the network and in the moment of error enter the impedance in series to the network and thus reduce the short circuit current of the system. Since changing the amplitude of the fault current can affect the relays and fuses and these effects are very negative and dangerous in the long run [5-6], there are many and various ways to eliminate these hazards, the most possible methods, are described and analyzed below.

- 1- Disconnection of DG: In this method, it is not possible to use the fast relay curve, and in the case of disconnection of DGs, the possibility of using some advantages of the presence of scattered products in the network is denied.
- 2- Using the adaptive method: This method requires a huge and very complex online infrastructure, which makes this method very costly and uneconomical.
- 3- Using FCL: This method is suitable in some cases, but it may impose heavy costs on some types of FCL including SFCLs.
- 4- Method of selecting the size of DGs without changing the protection settings: This method meets the protection needs in the presence of distributed generation sources.

In reference [15], it is expected that

adding DGs to the network, will increase the reliability, but this will cause the configuration of the recloser fuses, which will reduce the reliability of the network. In the reference [16], FCLs are used in series with DGs to prevent protection coordination problems in a closed-loop distribution network with directional overcurrent relays. In general, DGs such as PV-FC, MT, etc., due to the nature of their electricity generation, which are mainly DC or with a different frequency from the power frequency, need inverters, converters, and electronic devices to connect to the network. Due to the limitation of their switches in passing high currents, these devices limit the error current at the time of the error, and this limit is 1.2 to 2 times the rated current [17-23].

## 2. IMPACT OF DISTRIBUTED GENERATION SOURCES ON PROTECTION RELAYS

Figure 1 shows a schematic of a sample network with the presence of DGs. Load distribution studies become more complex as distributed generation resources are added to the network.

One of the effects of the presence of distributed generation sources in the network is to reduce the upstream fault current. In many cases, the mainstream transformer injects a larger fault current than the DG into the network. In this case, the fault current for faults between the main substation and the DG will not necessarily be reduced. If the DG is between the fault location and the main substation, it can reduce the fault current. It is necessary to study this reduction to minimize trips. In

other words, if DGs are significantly larger than the main substation, they can have significant effects on short-circuit current. The amount of short circuit current in the network depends on some factors such as the size of the DG output, the distance of the DG from the fault location, and the type of DG. This can also affect the reliability and safety of the distribution system. Figure 2 shows the equivalent circuit of the feeder to calculate the short-circuit current when a fault occurs at location F1. The distance between the fault location and the transformer ( $L = L_1 + L_2$ ) is modelled with the total impedance  $Z$ . The position of DG can be represented by the location coefficient  $x$  so that the distance between the transformer and DG is  $xL$ , and the impedance of the corresponding line is  $Z_1 = xZ$ , in which the impedance  $Z_s$  is equivalent

to the system's and  $Z_2$  is equal to  $(1-x)Z$ .

According to Figure 1, if a two-phase fault occurs at point F1 and DG is connected to bus C, it is observed that according to the model in figure 2, the higher the DG capacity, the shorter the current decreases and figure 3 shows the issue. Figure 4 shows the short-circuit current variations for different DG locations at a capacity of 10 MVA and 15 MVA. It can be seen that if the DG capacity is 10MVA, each fault current for CB2 is always greater than the fault current settings for CB2 in each situation. However, when the DG capacity is increased to 15 MVA, the short-circuit current range is less than the regulated current of CB2, which causes the relay to malfunction. For  $x$  between 13% and 77%, the current is less than the CB2 overcurrent relay settings, which causes a wrong trip.

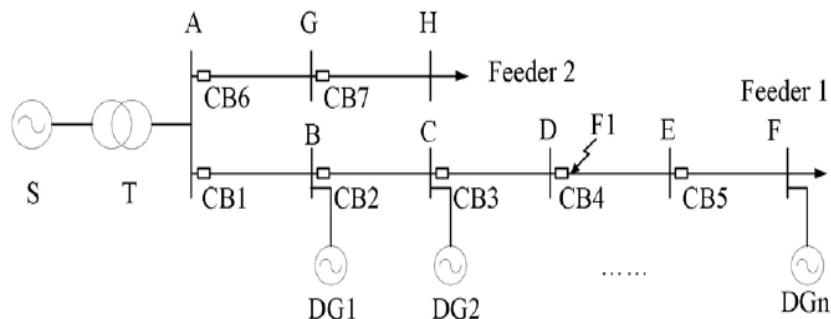

Fig. 1. Sample network despite distributed generation sources.

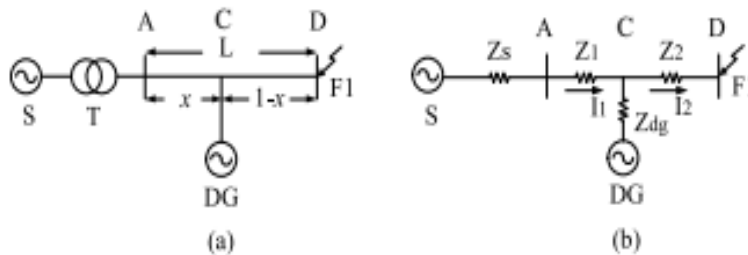

Fig. 2. The equivalent circuit of a distribution feeder with installed DG. (a) Distributed network with a DG (b) equivalent circuit.

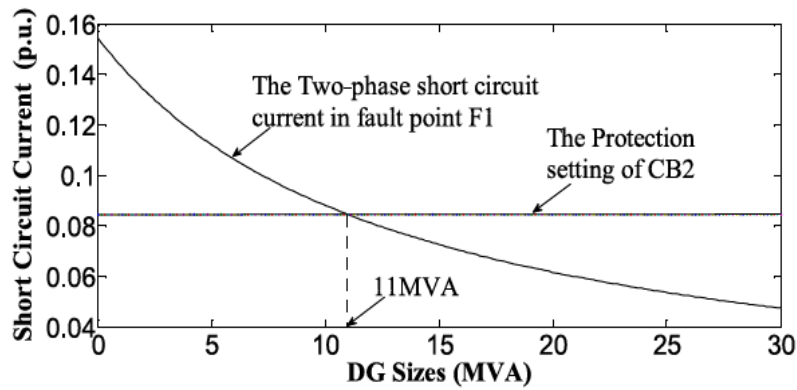

Fig. 3. The effect of DG size on short circuit current.

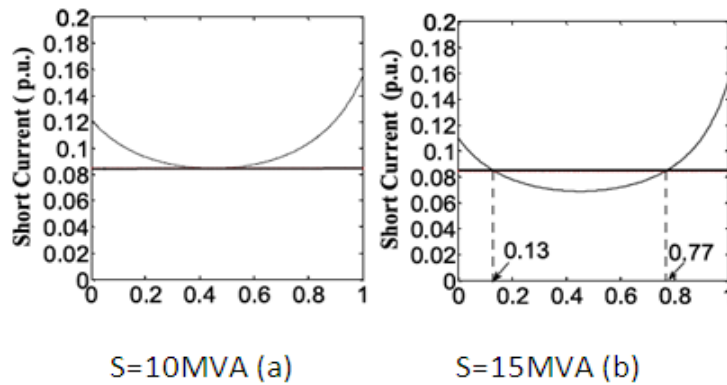

Fig. 4. The effect of location on flow.

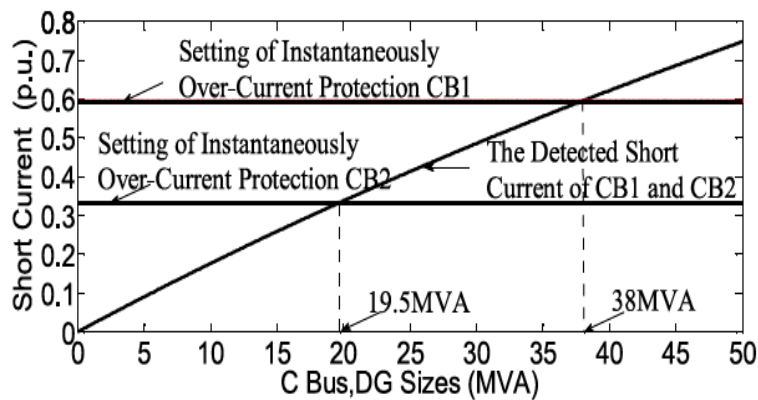

Fig. 5. Reverse flow diagram.

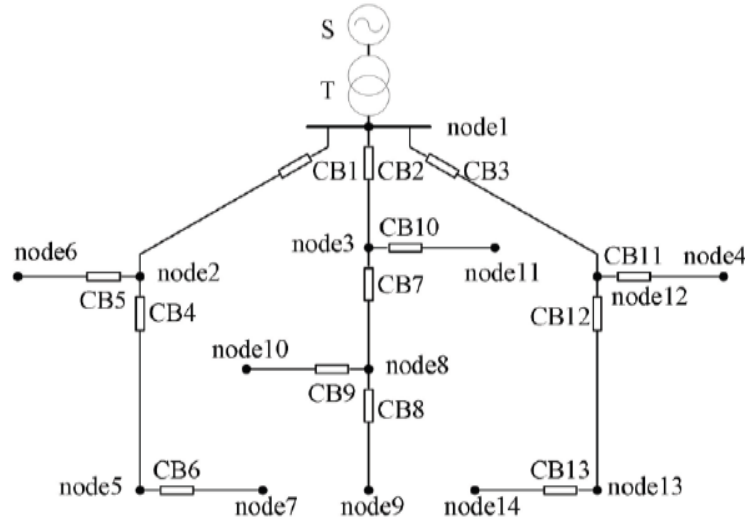

Fig. 6. Sample three feeder system.

Other negative effects of DG presence in the network include creating a reverse fault current in the network, which can be seen in Figure 5. can cause the relays to malfunction.

### 3. FORMULATION AND SIMULATION

Figure 6 shows a typical three-feeder system connected to a power plant bus. To calculate short-circuit currents in DG connection cases, the impedance matrix must be updated as follows:

$$Z_{ij,new} = Z_{ij} - \frac{Z_{ik} \times Z_{kj}}{Z_{kk} + jX_{djk}} \quad (1)$$

K is the bus which DG is attached to.

#### 3.1. The Objective Function

As shown in Figure 4, and according to the above, the addition of DG changes the short-circuit current and changes the protection setting. Therefore, the objective function is considered as follows, considering the

choice of maximum production of DGs without making changes in the protection setting and observing the restrictions, which shows the relation (2) of the objective function.

$$\text{Max}(S_{dg1} + S_{dg2} + \dots + S_{dgn}) \quad (2)$$

where  $S_{dg}$  is the capacity of each DG and  $n$  is the number of DGs.

When a short-circuit fault occurs at the end of an adjacent branch below the DG node, a reduction in sensitivity in the upstream protections shall not result in operation failure.

$$I_i^2(z, S_{dg}, F) > I_{OP,i}^* \quad i=1,2,3,\dots,n \quad (3)$$

$I_i^{(2)}$  Two-phase short-circuit currents in branch  $i$ ,  $I_{OP,i}^*$  Relay regulation current overload constant time in branch  $i$ ,  $z$  Distribution network structure and parameters (network impedance),  $S_{dg}$  Capacity vector DG,  $F$  Includes error information Such as the type of error and the location of the error. When a short-circuit

fault occurs at the end of an adjacent branch below a DG node, an increase in sensitivity in downstream protections should not lead to incorrect operation of the relays.

$$I_i = f(z, S_{dg}, F) < I_{OP,I} \quad i=1,2,3\dots m \quad (4)$$

When a short circuit fault occurs in an adjacent feeder, reverse current from the DGs to the fault point should not result in the faulty operation of the line relay in which the DG is installed.

$$I_i^r(z, S_{dg}, F) < I_{OP,I} \quad i=1,2,3\dots J \quad (5)$$

Also,  $m$  is the number of downstream branches and  $I_i$  is the three-phase short circuit current in-branch  $i$ .  $I_{OP,I}$  Instantaneous setting value for high current relays in branches  $i$  and  $J$  is the number of branches in which the reverse current flows and  $I_i^r$  expresses the reverse current of the three-phase short circuit.

### 3.2. Objective Function Constraints

There are two limitations to DG capacity. A) Total capacity limit of DG.

$$\sum_{j=1}^n S_{dgj} \leq T_{MAX} \quad (6)$$

$T_{MAX}$  stands for Total DG Capacity. B) Capacity limit of each DG.

$$S_{dgj} \leq S_{maxj} \quad j=1,2,3\dots n \quad (7)$$

$S_{MAX}$  is the authorized capacity of each DG. In the network of Figure 6, simulation studies are considered for two modes. The case where DG is connected to all rails except the generator bus and the case where DG is connected to five selected rails 6, 7,

10, 13, and 14. Table 1 shows the network relay settings without the presence of DG.

### 3.3. Optimization based on genetic algorithm

Genetic Algorithms (GA | Genetic Algorithms) are a family of computational models inspired by the concept of evolution. These algorithms encode possible answers or candidate answers or possible hypotheses for a particular problem into a chromosome-like data structure. The genetic algorithm preserves the vital information stored in chromosome-like data structures by applying recombination operators to it.

### 3.4. Coding

The locations and capacities of DGs should be converted into appropriate variables that can be examined in GA. Without losing the totality, it is assumed that a total of  $n$  DGs are installed in a distribution network and the capacity variables of  $n$  DGs are expressed in terms of,  $S_{dg1} \dots S_{dgi} \dots S_{dgn}$ . If DG is not present in node  $i$ ,  $S_{dgi} = 0$  otherwise,  $S_{dgi} \neq 0$ . Binary, decimal, and symbolic coding schemes are often used to convert real variables to GA representations. This article uses decimal coding.

### 3.5. GA Performance

Individual population size ( $M$ ) in GA is an important factor influencing performance and optimization outcomes. Too small a population cannot respond to large population diversity, and optimization is often localized optimally. On the other hand, if  $M$  is too large, it will lead to a heavy computational load and low efficiency.

Therefore, in this paper,  $M$  is set to 300. Accordingly, the intersection rate is 0.7 and the jump rate is 0.02. The following steps are performed in the GA method. 1) Input data: distribution network topology, line impedances, and relay settings. 2) Initialization: A large number of DG unit capacity/position combinations is randomly generated as the initial population of DGs and tested to meet the limitations of overcurrent protection. 3) Selection: Proportional selection in the current population can be used in the next population. 4) Collision: The collision strategy for applying a second sample of the results of the prototype is acceptable. 5) Mutation: Uniform mutation operation is used to produce the third generation of the

population from the second generation of the population. 6) Examine whether the results in the population function meet conservation constraints. If so, qualified results will be retained in the next generation. Otherwise, they are discarded. 7) End if one of the stop criteria, such as the total number of production, has reached the predetermined limit. Otherwise, continue to the fitness calculation step.

The fit function is proportional to the performance of the target function.

As mentioned above, our optimization goal is to maximize the total DG capacity without changing the existing relay protection, as presented in (8).

$$\text{MAX}(S_{dg1}+S_{dg2}\dots S_{dgn}) \quad (8)$$

**Table 1. Test network relay settings with three feeders.**

Number	Line	$I_{OP,i}(P.U)$	$I^*_{OP}(P.U)$
CB1	1-2	1.9824	0.6099
CB2	1-3	1.9360	1.2706
CB3	1-12	1.9360	0.4122
CB4	2-5	1.5031	0.1976
CB5	2-6	1.6488	0.2400
CB6	5-7	1.4177	0.1412
CB7	3-8	1.6155	0.8019
CB8	8-9	1.3749	0.3501
CB9	8-10	1.3597	0.0565
CB10	3-11	1.5939	0.0960
CB11	4-12	1.5854	0.0875
CB12	12-13	1.6155	0.2344
CB13	13-15	1.5113	0.1694



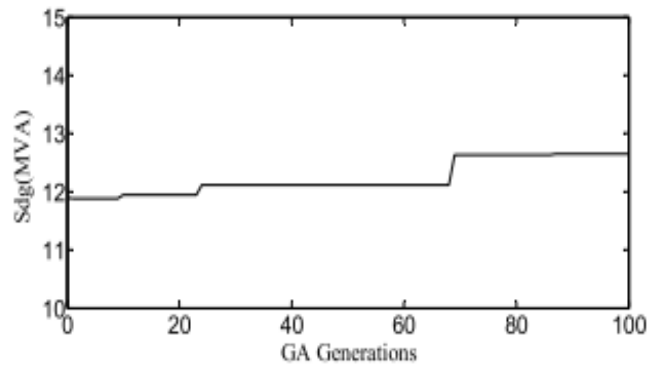

*Fig.7. Changes in the optimal capacity of DG in case of connection.*

**Table 2. Optimal sizing of the three-feeder system in the presence of DG (all buses are considered).**

bus	2	3	4	5	6
DG capacity MVA	0.5064	0.0121	0.6755	0.4662	1.1505
Bus	7	8	9	10	11
DG capacity MVA	7.0000	1.0359	1.1920	0.1682	0.1144
Bus	12	13	14		
DG capacity MVA	0.1733	0.0897	0.0648		

**Table 3. Sizing and location of DGs in 33 bus system.**

bus	3	4	5	6	7
DG capacity MVA	0.0970	0.0462	0.0930	0.0792	0.0814
Bus	8	9	10	11	12
DG capacity MVA	0.0549	0.0258	0.0360	0.0831	0.0903
bus	13	14	15	16	19
DG capacity MVA	0.0921	0.0970	0.0957	0.0291	0.0174
bus	20	21	22	23	24
DG capacity MVA	0.0698	0.0711	0.0903	0.0934	0.0502
bus	25	26	27	28	29
DG capacity MVA	0.0994	0.0825	0.0468	0.0957	0.0909
bus	30	31			
DG capacity MVA	0.0751	2.0000			

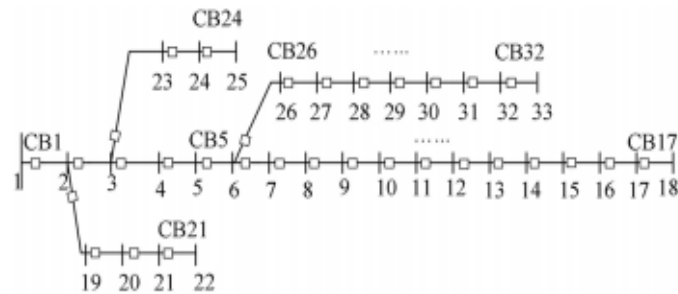

Fig. 8. IEEE 33 bus standard system.

Table 4. Sizing and location of DGs in the 33-bus system, taking into account the capacity of DGs.

bus	3	4	5	6	7
DG capacity MVA	0.0863	0.0923	0.0921	0.0701	0.0973
bus	8	9	10	11	12
DG capacity MVA	0.0910	0.0916	0.0765	0.0602	0.0641
bus	13	14	15	16	19
DG capacity MVA	1.0000	0.0772	0.0666	0.0454	0.0756
bus	20	21	22	23	24
DG capacity MVA	0.0188	0.0926	0.0345	0.0103	0.0616
bus	25	26	27	28	29
DG capacity MVA	0.0575	0.0509	0.0421	0.0502	0.0684
bus	30	31			
DG capacity MVA	0.995	0.9960			

Accordingly, the fitness function for evaluating the desired cases in the network can be defined as follows:

$$\text{Fitness} = S_{dg1} + S_{dg2} + \dots + S_{dgn} \quad (9)$$

The answers obtained for the capacity of DGs in the case that the DG is connected to the selected buses 6, 7, 10, 13, and 14 are as follows: DG6= 0.197 P.U , DG7= 0.452 P.U , DG10= 0.704 P.U , DG13= 0.26 P.U , DG14= 0.251 P.U

Figure 8 shows a standard 33 bus system. Tables 3 and 4 show the different bus sizes and locations for different DG values without considering the capacity limit and considering the DG production capacity limit.

Convergence diagrams are shown in Figures 9 and 10. The data in table 5 also shows that only inductive FCLs are suitable for this network. In addition, in the absence of an FCL source for this case, the optimization for the best fitness values is

**Table 5. Results of DG capacity in three and two buses with the presence of FCL.**

Genetic algorithm results for three DGs in the presence of FCL				
DG number	Location	FCL size	FCL source	Best fitness
DG1 1.5MVA	2	6.515+9.478J		
DG2 1.5MVA	3	1.592+9.337J		
DG3 1.5MVA	19	0.097+5.584J	0.129+0.212J	7.81
Genetic algorithm results for two DGs in the presence of FCL				
DG number	Location	FCL size	FCL source	Best fitness
DG1 2MVA	2	0.886+2.202J		
DG2 2MVA	19	2.575+8.096J	0.071+0.206J	3.18

**Table 6. Results of the genetic algorithm without FCL.**

Performance mode	Best fitness
2DG	107.52
3DG	144.91

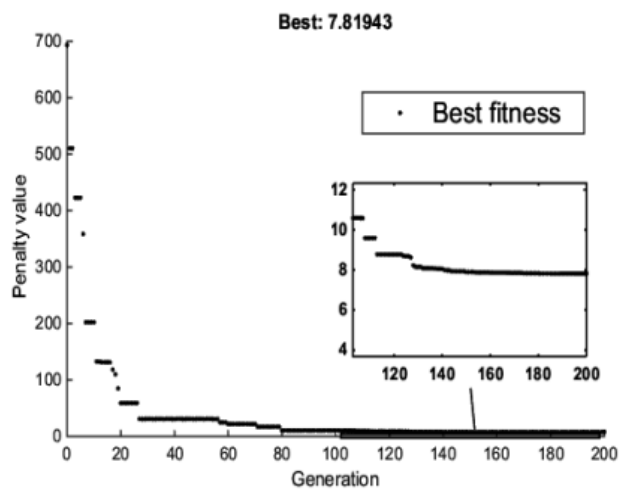
**Fig. 9. Convergence diagram of three DGs in a 33-bus system.**

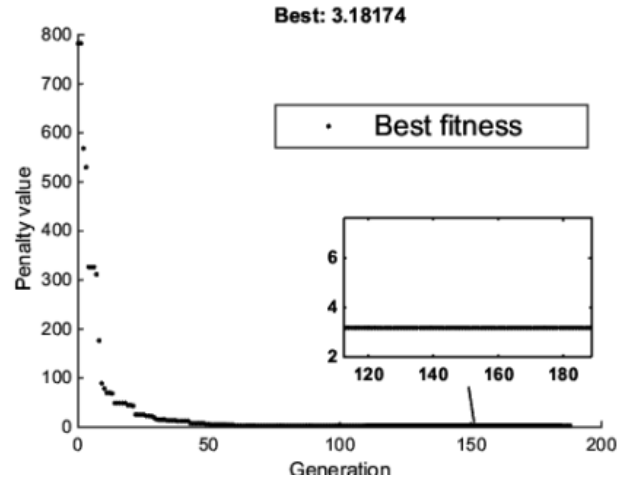

*Fig. 10. Convergence diagram of two DGs in 33 bus system.*

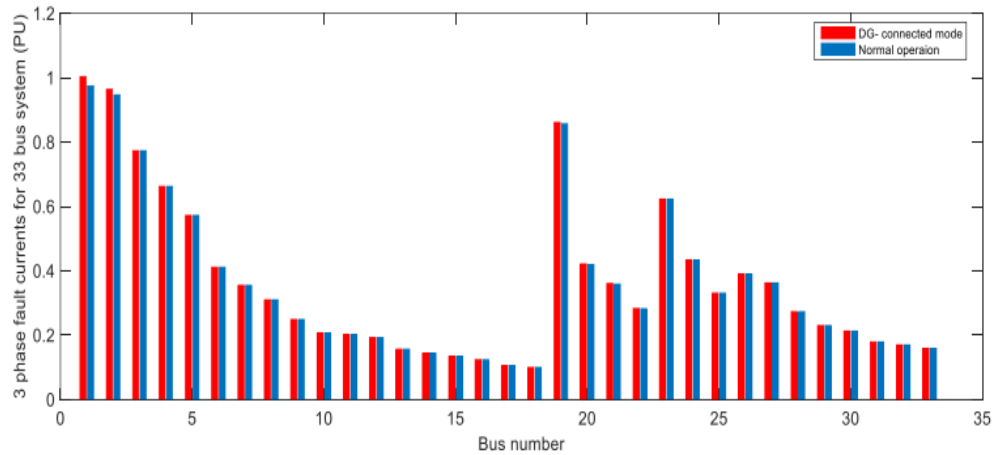

*Fig. 11. Comparison of three-phase fault current flow after optimal DG positioning and FCL utilization.*

presented in table 6, and fitness is a function of the difference between the two impedance matrices. As clearly shown in tables 5 and 6, the fitness values in the absence of FCL in the network are much higher than the values in the presence of FCL in the network. Therefore, it can be concluded that optimization without the presence of FCL was not successful.

Figure 11 also shows a bar chart comparing the fault currents in the 33-bus system. While figure 11 shows that the fault current is equal in two modes of using FCL

and without using it, so there is no problem in the field of protective coordination.

#### 4. CONCLUSION

In this paper, a method for locating and sizing DGs in the network without changing the protection system with the presence of FCL and without it in the network to maximize the capacity of DG on the network was expressed. Examples were also given to show the effect of distributed generation sources on fault currents and

operating modes of relays. In addition, we expressed a systematic method for formulating the problem by considering the conditions and requirements of the short circuit current protection system to prevent all types of trips or errors leading to incorrect tripping. A program based on a genetic algorithm has been developed to solve the optimization problem. The proposed method was tested and simulated on a standard 33 bus distribution system. There are also many practical limitations, including the number of buses that DG can be connected to, and the capacity of DGs in this article. The simulation results under different scenarios show the effectiveness of the method. More and more DG resources are being added to distribution networks, and DG capacity is expected to continue to grow, the method described in this article provided us with valuable data to keep the protection setting after adding DG to the network.

## REFERENCES

- [1] E. M. Lightner and S. E. Widergren, "An orderly transition to a transformed electricity system," *IEEE Transactions on Smart Grid*, Vol. 1, No. 1, pp. 3–10, Jun. 2010.
- [2] A. Molderink, V. Bakker, M. G. C. Bosman, J. L. Hurink, and G. J. M. Smit, "Management and control of domestic smart grid technology," *IEEE Transactions on Smart Grid*, Vol. 1, No. 2, pp. 109–119, Sep. 2010.
- [3] D. S. Popovic and E. E. Boskov, "Advanced fault management as a part of smart grid solution," in *Proceedings IET CIRED Seminar: Smart Grids Distribution*, pp. 1–4, Jun. 2008
- [4] S. M. Brahma and A. A. Girgis, "Development of adaptive protection scheme for distribution systems with high penetration of distributed generation," *IEEE Transactions on Power Delivery*, Vol. 19, No. 1, pp. 56–63, Jan. 2004.
- [5] R. A. Walling, R. Saint, R. C. Dugan, J. Burke, and L. A. Kojovic, "Summary of distributed resources impact on power delivery systems," *IEEE Transactions on Power Delivery*, Vol. 23, No. 3, pp. 1636–1644, 2008.
- [6] N. Nimpitiwan, G. Heydt, R. Ayyanar, and S. Suryanarayanan, "Fault current contribution from synchronous machine and inverter based distributed generators," *IEEE Transactions on Power Delivery*, Vol. 22, No. 1, pp. 634–641, Jan. 2007.
- [7] A. Dogan, and M. Alci. "Simultaneous Optimization of Network Reconfiguration and DG Installation Using Heuristic Algorithms." in *Elektronika ir Elektrotechnika*, vol. 25, no. 1, pp. 8-13, 2019.
- [8] M. Kanabar, V. Muthukrishnan, D. Patel, P. Parikh and M. Pilon, "Integrated asset monitoring, personnel safety, and reliability with next generation protection relays for distribution networks," in *CIRED - Open Access Proceedings Journal*, vol. 2017, no. 1, pp. 1242-1245, 10 2017
- [9] M. N. Alam, "Adaptive Protection Coordination Scheme Using Numerical Directional Overcurrent

- Relays," in *IEEE Transactions on Industrial Informatics*, vol. 15, no. 1, pp. 64-73, Jan. 2019
- [10] T. S. Aghdam, H. Kazemi Karegar and H. H. Zeineldin, "Variable Tripping Time Differential Protection for Microgrids Considering DG Stability," in *IEEE Transactions on Smart Grid*, vol. 10, no. 3, pp. 2407-2415, May 2019.
- [11] U. Akram, M. Khalid, S. Shafiq, "Optimal sizing of a wind/solar/battery hybrid grid-connected microgrid system" *IET Renewable Power Generation*, Vol. 12, No. 1, pp. 72-80, 2018
- [12] A. Hooshyar, R. Iravani, "A new directional element for microgrid protection", *IEEE Trans. Smart Grid*, vol. 9, no. 6, pp. 6862-6876, 2018
- [13] S.B. Naderi, M. Negnevitsky, A. Jalilian, M. Hagh, K. Muttaqi, "Optimum resistive type fault current limiter: an efficient solution to achieve maximum fault ride-through capability of fixed speed wind turbines during symmetrical and asymmetrical grid faults", *IEEE Trans. On Industry Applications*, vol. 53, no. 1, pp. 538-548, 2017
- [14] E. Dehghanpour, H. Kazemi Karegar, R. Kheirollahi and T. Soleymani, "Optimal Coordination of Directional Overcurrent Relays in Microgrids by Using Cuckoo Linear Optimization Algorithm and Fault Current Limiter," in *IEEE Transactions on Smart Grid*, vol. 9, no. 2, pp. 1365-1375, March 2018
- [15] S. Chaitusaney and A. Yokoyama, "Prevention of reliability degradation from recloser-fuse miscoordination due to distributed generation," *IEEE Transactions on Power Delivery*, Vol. 23, No. 4, pp. 2545-2554, 2008.
- [16] W. El-Khattam and T. Sidhu, "Restoration of directional overcurrent relay coordination in distributed generation systems utilizing fault current limiters," *IEEE Transactions on Power Delivery*, Vol. 23, No. 2, pp. 576-585, Apr. 2008.
- [17] M. Noe, M. Steurer, S. Eckroad, and R. Adapa, "Progress on the R&D of fault current limiters for utility applications," in *IEEE Power and Energy Society General Meeting-Conversion and Delivery of Electrical Energy in the 21st Century*, pp. 1-4, Jul. 2008.
- [18] B. Boribun and T. Kulworawanichpong, "Comparative study on a fault current limiter with thyristor-controlled impedances," in *13th International Conference on Harmonics and Quality of Power*, pp. 1-5, 2008.
- [19] M. M. A. Salama, H. Temraz, A. Y. Chikhani, and M. A. Bayoumi, "Fault-current limiter with thyristor-controlled impedance," *IEEE Transactions on Power Delivery*, Vol. 8, No. 3, pp. 1518-1528, Jul. 1993.
- [20] E. Sortomme, S. S. Venkata, and J. Mitra, "Microgrid protection using communication-assisted digital relays," *IEEE Transactions on Power Delivery*, Vol. 25, No. 4, pp. 2789-2796, Oct. 2010.
- [21] H. Nikkhajoei and R. H. Lasseter,

- “Microgrid protection,” in IEEE Power Engineering Society General Meeting, pp. 1–6, Jun. 2007.
- [22] M. Dewadasa, R. Majumder, A. Ghosh, and G. Ledwich, “Control and protection of a microgrid with converter interfaced micro sources,” in International Conference on Power Systems (ICPS), pp. 1–6, Dec. 2009.
- [23] Y. Han, X. Hu, and D. Zhang, “Study of adaptive fault current algorithm for microgrid dominated by inverter based distributed generators,” in 2nd IEEE International Symposium on Power Electronics for Distributed Generation Systems (PEDG), pp. 852–854, Jun. 2010.