

Recent advances in ISFET-based biosensors for the detection of biomarkers: History, principles, gate structure and applications

Seyed Saman Nemati ^a, Gholamreza Dehghan ^{b*}, Yaser Abdi ^b, Sohrab Ahmadi-Kandjani ^{c,d}

a Department of Biology, Faculty of Natural Sciences, University of Tabriz, 51666–16471 Tabriz, Iran

b Nanophysics Research Laboratory, Department of Physics, University of Tehran, 1439955961 Tehran, Iran

c Research Institute for Applied Physics and Astronomy (RIAPA), University of Tabriz, Tabriz, Iran

d Faculty of Physics, University of Tabriz, Tabriz, 51663-165, Iran

*Corresponding Author Email: gdehghan@tabrizu.ac.ir

DOI: 10.71498/ijbbe.2024.976364

ABSTRACT

Received: Jun. 2, 2024, Revised: Aug. 6, 2024, Accepted: Nov. 28, 2024, Available Online: Jan. 5, 2025

Using ion-sensitive field effect transistor (ISFET) sensors is one of the most prominent signal detection and measurement methods for various analytes and biomarkers. Here the history of the ISFET sensors and their general operations are reviewed. Because of the extreme importance of gate performance and structure in sensitivity, price, reusability, durability, and stability of ISFET sensors, the gate materials and structures have been the subject of many studies. In addition, the importance of gate materials in ISFET sensor readout methods is reviewed here. The applications of ISFET as super biosensors with high sensitivity, easy manufacturing methods, sufficient stability, and cost-effectiveness in measuring ions, DNA, biomarkers, and analytes based on enzyme activity, are highlighted. Finally, the importance and advantage of using ISFET sensors with bioactive nanomaterial layers are emphasized, and future studies of these sensors, based on our point of view, are discussed.

KEYWORDS

ISFET sensor; Gate materials; Biosensor; Enzymatic ISFET assay.

ABTS	2, 2-azino-bis 3-ethylbenzothiazoline-6-sulphonic acid
ABTES	3-aminopropyltriethoxysilane
AChE	Acetylcholinesterase
BSA	Bovine serum albumin
API	Active pharmaceutical ingredients
Cpy	Chlorpyrifos
CMOS	Complementary metal-oxide semiconductor
CVCC	Constant-Voltage, Constant-Current
C-PPy	Carboxylated polypyrrole
DG	Double-gate
DG-CNT-ISFET	Dual-gate carbon nanotube ISFET
DNA	Deoxyribonucleic acid

EG-ISFET	Extended-gate ISFET
ENFET	Enzyme based ISFETs
FET	Field effect transistor
F-rGO	Fluorinated-reduced graphene oxide
I_{DS}	Drain-source current
ITO	Indium tin oxide
ISFET	Ion-sensitive field effect transistor
IUPAC	International Union of Pure and Applied Chemistry
GFET	Graphene field effect transistors
HLA	Human leukocyte antigen
HRP	Horseradish peroxidase
JFET	Junction FET
JF-ED-TFET	Junction-free tunneling field-effect-based biosensor
MHC	Major histocompatibility complex
MESFET	Metal-semiconductor FET
MOSFET	Metal- oxide-semiconductor FET
MICA	MHC associated with class I related chain A
LAMP	Loop-mediated isothermal amplification
LOD	Limit of detection
PBSE	1-pyrenebutanoic acid succinimidyl ester
rCV-N	Recombinant cyanovirin-N
SOI-DG ISFET	Silicon-on-insulator dual-gate ISFET
Si NW	Silicon nanowire
SGGT	Solution-gated graphene transistors
V_{DS}	Drain-source voltage
UT	Ultrathin body

I. INTRODUCTION

Ultra-sensitive biosensors equipped with nanotechnology have the potential for early and accurate medical and genetic diagnosis. With the development of different sensory methods, academic researchers have become interested in this topic. Precision biosensing tools and test strips are improving and transitioning from optical and/or electrochemical to electronic technologies [1, 2]. Thus, those interested in biosensors must investigate the structure, performance, and recent applications of electronic-based biosensors because they have the potential to become one of the main sensor technologies for medical diagnosis applications.

According to the International Union of Pure and Applied Chemistry (IUPAC) definition, biosensors use specific biochemical reactions mediated by the immune system, isolated enzymes, tissues, whole cells, or organelles to detect chemical compounds by optical, electrical or thermal signals [3]. Thus,

biosensors are analytical tools for monitoring biological dynamics, interactions, and activities [4]. A biosensor consists of three main parts, including a bio-detection element, a transducer, and a signal processing unit. Biomolecules cause changes in physical quantities such as charge, photon, or mass, and the transducer senses these changes converting them into electrical signals, voltage or current. Ultimately, to determine the sensing results, the signals are amplified and analyzed.

According to different output signals, the traditional methods of monitoring the electrochemical reactions are divided into optical [5-7] and classical three-electrode systems [8]. The optical method is based on light changes during electrochemical reactions (Fig. 1) [9-11]. One of the disadvantages of this method is the need for a complex, expensive, and large device to achieve high sensitivity [12]. In contrast, the classical three-electrode system has advantages such as high sensitivity and low production cost (Fig. 1). However, the mass production of a three-electrode system and its integration into other systems is challenging due to the lack of a common

production standard [13]. To overcome this challenge, the ion-sensitive field-effect transistor (ISFET) was developed in 1970 [14].

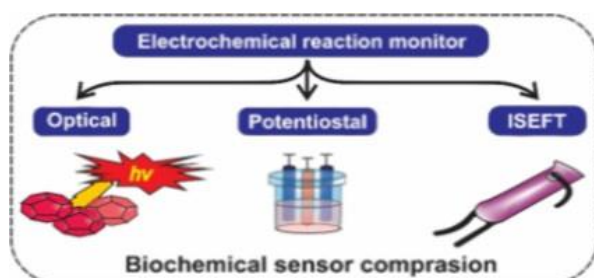

Fig. 1 Classification of conventional electrochemical sensors.

In biosensing mechanisms, an interesting approach, namely field effect transistor (FET)-based biosensor was considered a reliable approach. In addition, due to the rapid development of solid-state technologies there are many options to move forward. Most biomolecules carry electrostatic charges and bioactivities involving changes in electrical potential. Thus, FET-based biosensors are a suitable option for fast and ultra-sensitive detection of biomarkers [15]. ISFET biosensors are FET-type biosensors, which measure ions concentration in solutions. In the ISFET the solution is used as the gate electrode and the other parts follow the conventional FET devices. The change in concentration of an ion such as H^+ accordingly changes the current through the FET. ISFET biosensors are extremely sensitive and have the advantage of good scalability, intrinsic amplification, acid-alkali resistance, water repellent, impact resistant, fast real-time detection, direct electrical readout, and lower power requirements compared to other electrochemical and optical sensing devices. Furthermore, they are superior to cyclic process voltmeters with simple direct electrical readout and complementary metal-oxide semiconductor (CMOS) compatibility [16-18].

The use of ISFETs in DNA sensing has been specifically discussed in the review articles [19, 20]. ISFET applications in medicine have also been reviewed [21]. In the review article by *Cao et al.*, many topics of ISFET and its applications in biosensors have been covered, but the materials used in the gate terminal structure have not been investigated specifically [13]. Therefore, in this review, first, a brief history of ISFET sensor performance in general is presented and the manufacturing and improvement of ISFET sensor performance is discussed. Then, there is more focus on the materials and gate structure of ISFET sensors as their most sensitive and key part. Also, readout methods of ISFET sensors and their application as biosensors will be discussed. So, the main purpose of this review, in addition to reviewing recent research, is to create a proper background of the entire ISFET structure and performance, focusing more on the biosensing application of ISFET.

II. HISTORY OF ISFET SENSORS

The ISFET sensors consist of a sensing element and a transducer. All stages of development and improvement of ISFET devices and their sensing applications are presented in

Table 1. In recent decades the progress in the use of ISFET as sensors have been impressive and have become the favorite biosensors for biochemists. Advances have been made to the extent that a multifunctional sensor could be used to measure several analytes [22]. A schematic of sensors with multiplex functions is shown in **Error! Reference source not found.**

TABLE 1. TIMELINE OF PROGRESS IN THE CONSTRUCTION AND OPTIMIZATION OF ISFET BIOSENSORS

Advanced process in ISFET		Year	Ref.
1	ISFET originated from FET ^a .	1925	[23]
2	Suggesting different types of FET depending on the type of gate structure (such as JEFET ^b and MESFET ^c).	1952	[24]
3	Using a semiconductor process, the MOSFET ^d uses a metal-semiconductor junction to replace the p-n junction of the JFET for easier fabrication and higher operating speed.	1960	[25]
4	Despite the low speed and ease of damage, the MOSFET was used as a low-cost signal converter with easy fabrication on a large scale.	1962	[26]
5	Quantitative detection of Na ⁺ with source-drain current output (I_{DS}) as the first ISFET sensor with direct oxide-solution contact by removing the metal gate structure MOS.	1970	[14]
6	Replacing metal oxides in MOSFET with an aqueous solution in ISFET.	1972	[27]
7	Using an ISFET with a gate made of noble metal as a gas sensor.	1975	[28]
8	Application of ISFET to identify penicillin biomolecules through enzymatic reactions.	1980	[29]
9	Placement of sensing films instead of metals in the structure of MOS and its explanation by the <i>Bousse</i> site dissociation model.	1983	[30]
10	Optimizing the size of the sensors by making a miniaturized urea biosensor using an enzyme on the ISFET gate.	1984	[31]
11	Improving the anti-interference performance of ISFT-based biosensors for simultaneous detection of urea and glucose	1985	[32]
12	Detection with acceptable sensitivity of H ⁺ , by the structure of ISFET containing different sensitive films (such as Ta ₂ O ₅ , Si ₃ N ₄ , Al ₂ O ₃) on the insulating oxide layer.	1987	[33]
13	Detection of urea in human blood serum using GATE enzymatic modification in ISFET.	1995	[34]
14	ISFET sensor development is based on clinical applications focused on the detection of antibodies, glucose, DNA, and cells.	2001	[35]

a Field effect transistor; b, junction FET; c, Metal-semiconductor FET; d, Metal- oxide-semiconductor FET.

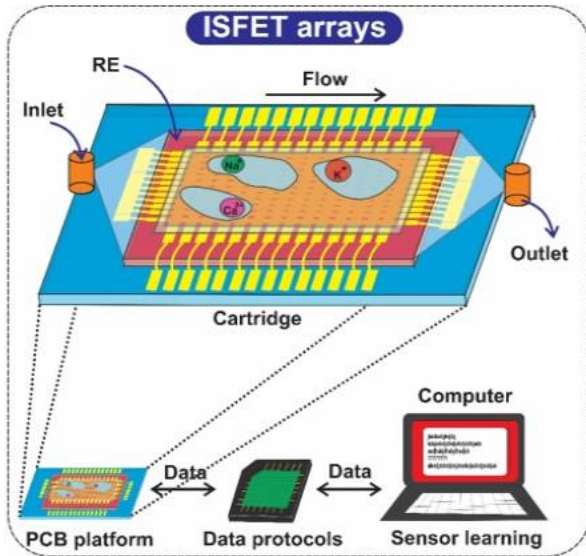

Fig. 2 Schematic of the ISFET arrays application for multiple detections.

III. PRINCIPLES OF ISFET SENSORS ACTION

The ISFET results from replacing the gate electrode with a solution, a chemically sensitive membrane, and a reference electrode in a conventional metal oxide silicon field effect transistor (MOSFET) (Figure 3A-C). The channel resistance in ISFET depends on the electric field perpendicular to the current direction (same as MOSFET). Charges in solution are held on the top of an insulating ion-

sensitive membrane. The dependence of the surface potential on the charge concentration is explained by the well-known site-binding theory [36].

Anisotropic ion accumulation occurs at the interface between an electrochemically active surface and a liquid electrolyte (Figure 3D). Due to the differences in the amount and charge, an electric double layer will be formed by the ions near the surface, and a diffuse layer of external charges will result between the neutral volume of the solution and the Helmholtz planes, according to the Gouy – Chapman theory [37]. When SiO₂ is used as an insulator, the surface of the gate oxide contains activated –OH, which is in electrochemical equilibrium with the ions in the solution (OH⁻ and H⁺). Hydroxyl groups are protonated or deprotonated on the gate oxide surface. As a result, due to the contact of the gate oxide with the aqueous solution the change in pH causes a change in the potential of the SiO₂ surface. Signal transmission is considered a function of the ionization state of the SiOH groups of the amphoteric surface [38]:

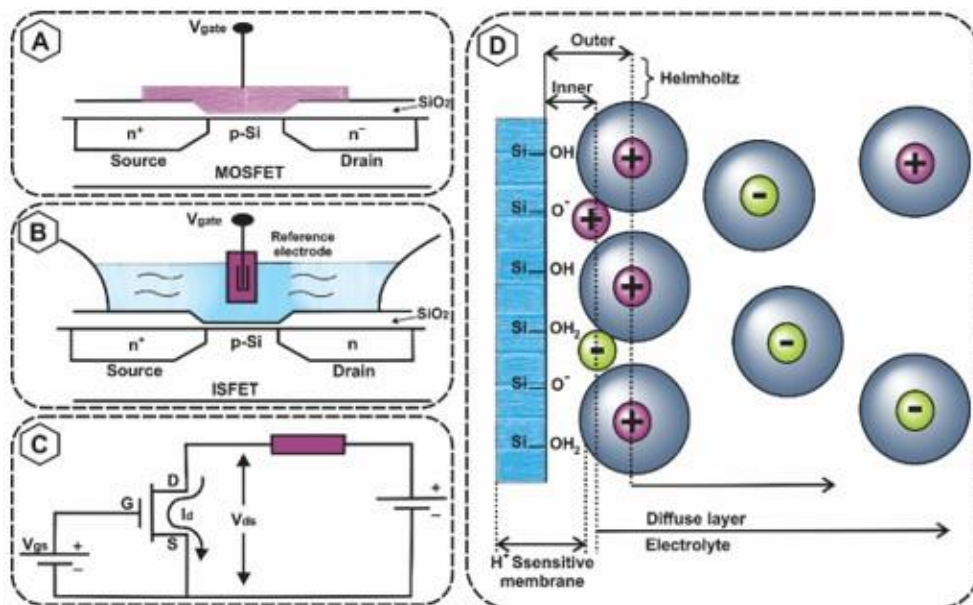
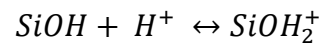
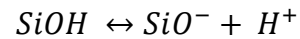

Fig. 3 (A) Basic structure of metal-oxide-semiconductor field effect transistor (MOSFET); (B) Basic structure of ion-sensitive field effect transistor (ISFET); (C) Simple circuit of an ISFET sensing system; and (D) Electrical double layer adjacent to the SiO₂ surface.

The selectivity and chemical sensitivity of the ISFET sensors depend on the insulating properties of the insulator and/or electrolyte interface. In this regard, oxide coating minerals such as SiO₂, Si₃N₄, Al₂O₃, or Ta₂O₅ can be used to obtain the desired pH response [39] (Table 2).

TABLE 2. EXAMPLES OF pH SENSOR SPECIFICATIONS.

Sensitive layer	pH range	Sensitivity (mV/pH)
Ta ₂ O ₅	2 – 12	56 – 58
Si ₃ N ₄	2 – 12	53 – 55
Al ₂ O ₃	2 – 12	54 – 56

The protonation/deprotonation of the gate is controlled by the pH in the gate region [40]. Sensor responses are according to Nernst's law (59.2 mV/pH). The response of an ion-selective electrode is given by:

$$E = E_0 + \left(\frac{RT}{zF}\right) \ln[i]$$

where E is measured potential (V); E₀ is characteristic constant for the ion-selective/external electrode system; T is temperature (K); R is gas constant; F is Faraday's constant; [i] is molar concentration of free unimixed ionic species; and z is the signed ionic charge [41].

IV. GATE MATERIALS IN ISFET SENSORS

The ISFET sensor's gate material is a sensitive layer in direct contact with the target solution,

forming the gate dielectric/insulator layer. In ISFET sensors, the control of the drain-source current is done through the gate potential generated at the interface between the sensor membrane and the solution. In choosing the right gate material for ISFET sensors, which is stable and performs well, more attention should be given to the high energy band gap, more connection sites for modification, and high dielectric properties [42]. To measure mineral ions, sensitive membranes are deposited on the gate layer, and other macromolecules are detected by adding a specific amount of antibody/enzyme/RNA to a specific reaction. The change in the analyte concentration is reflected by the change in the proton concentration of the environment [43].

After replacing the metal gate in the MOSFET with an aqueous solution to construct an ISFET sensor, various materials have been used in the construction of the ISFET gate [27]. Oxides have always played the role of coloring [44, 45]. The oxides are based on the effect of H⁺ released from the solution's dynamic in the pH of the well, which changes the surface potential of the oxide layer as well as the potential between the gate and the base of the underlying field effect. Apart from oxides, other materials act as selective membranes for ions, which are explained in Table 3. Due to the importance of the gate material in ISFET sensor's function, they will be further discussed and the latest developments in the field will be reviewed next.

TABLE 3. DIFFERENT MATERIALS AS GATE-SENSITIVE LAYERS.

Thin film	
SiO ₂	Single-layer SiO ₂ stacked with other thin layers, such as SiO ₂ /HfO ₂ /Al ₂ O ₃ , has improved performance [46]. First, Al/SiO ₂ /Si layers were used as hepatitis B antigen sensors [47].

Ta ₂ O ₅	<p>In 1981, Ta₂O₅ was one of the most suitable materials known as a gate layer for pH sensing [47]. In 1989, the first gate Ta₂O₅ ISFET sensor with a differential amplifier was built. The output of one amplifier was amplified with a Ta₂O₅/SiO₂ ISFET gate, while the output of the other amplifier was amplified with a SiO_xN_y/Si₃N₄/SiO₂ ISFET gate. [47]. In this system, an external reference electrode was not required.</p>
Nitrides	<p>Nitride is used to measure many biomarkers. For example, in addition to being watertight, Si₃N₄ has excellent chemical stability for sensing H⁺. With an ion-sensitive layer on top of the Si₃N₄ gate in the ISFET, it measures a variety of biomarkers [13].</p> <p>Indium Nitride (InN) has enabled the high sensitivity of pH measurement. Accumulation of surface electrons in InN results in a large ion-induced surface potential to drive current in the ultrathin conducting channel, and as a result, sufficient gate bias in the electrolyte modulates the electron density in the ultrathin conducting channel, and the ratio of current changes increases significantly [48].</p> <p>Gallium nitride (GaN) is engineered with the advantage of a wide energy gap through anisotropy design. It has high conductivity at zero discharge valve voltage and thus high sensitivity [49].</p>
Al ₂ O ₃	<p>Al₂O₃ was first used in 1979 as a chemically stable assay in pH measurement [50]. In contrast to commercial FETs, in the case of this Al₂O₃ ISFET, the pH sensitivity for small sensing areas (about 0.1 mm²), is not affected and thus the analysis of integrated samples is possible [51]. Other Al-based materials have also been used as ISFET gates, such as aluminum metal and aluminum nitride [52, 53].</p>
Other oxides	<p>Zinc oxide (ZnO), hafnium oxide (HfO₂), palladium oxide (PdO), and many composite oxides are attractive ion-sensitive membranes. ZnO can achieve a wide range of pH sensing with linear response, and the HfO₂ gate deposited by ALD can minimize the oxygen vacancies to reduce the bound ions on the sensor film surface. Indium-gallium-zinc-oxide thin film for n-type gate material and pH sensing membrane simultaneously provided a flexible sensor based on an oxide film prepared with a temperature sensor for real-time measurements to provide an integrated and flexible personalized bioelectronic pathway [54]. Indium zinc oxide (InZn_xO_y) can be used to measure pH [55].</p>
Polymers	<p>Polymer/organic gates broaden the variety of target analytes with ISFET sensors, such as modifying polyaniline protonated with dinonylnaphthalene sulfonic acid (PANI/DNNSA) as gate material for an ISFET polyethyleneimine sensor [56].</p>

Two-dimensional materials

Graphene	<p>Graphene has higher carrier mobility than silicon at room temperature and more electron mobility with temperature change [57]. Due to its high sensitivity to surface charge and strong interaction with ionic adsorbates, it can act as an excellent material for electron-proton conversions. It has been used in the detection of Na⁺, Co²⁺, Al³⁺, and others in ISFET sensors [43].</p>
MoS ₂	<p>In 2011, a transistor was made with a molybdenum sulfide (MoS₂, 0.65 nm thick) sheet [58]. ISFET with MoS₂ gate has been used to measure glucose [59], hydrogen peroxide [60], heavy metal ions [61], and proteins [60].</p>
Black phosphorus	<p>Black phosphorus is a layered semiconductor with high carrier mobility and controllable bandgap for the design of nanoscale transistors for the detection of nitrogen dioxide gas, heavy metal ions, and immune proteins [62-64].</p>
Metal carbides, nitrides, and carbonitrides	<p>Two-dimensional carbonitrides, transition metal carbides and nitrides (Mxenes) are graphene-like structures composed of transition metal carbides, nitrides, or carbonitrides that have high conductivity and much low resistance. They have been used in biosensors</p>

since 2011 [65]. For example, they have been used to detect dopamine [66], metal ions [67, 68], and COVID-19 [69].

Other nanostructures

Si nanowires	Si nanowire-based ISFETs with a high surface-to-volume ratio increase the threshold voltage and gate capacitance, resulting in excellent ion-sensing properties [70].
Carbon nanotubes	By placing carbon nanotubes along the channel, the electrical properties of the devices are significantly improved [71].
Others	Nanostructured materials with high surface-to-volume ratios have been used to actuate ISFET sensors for protein sensing [72]. ISFET sensors based on zinc oxide nanorods have been used for glucose monitoring [73], pH testing [74], and DNA detection [75]. Vanadium pentoxide (V_2O_5) nanorods have also been used to fabricate ISFET sensors [76].

A. Recent gate materials used in ISFET sensors.

In the study of Phanabamrung et al., Si_3N_4 was used as the gate covering layer of ISFET to design a sensor based on the antibody-antigen connection of the major histocompatibility complex (MHC) associated with class I related chain A (MICA), and also human leukocyte (HLA). The detection linear range for MICA and HLA was 5.17–40 and 1.98–40 $\mu\text{g/mL}$, respectively, which indicates the device's good performance. Thus, in this study, the use of Si_3N_4 for the gate layer was very suitable with high modification [77]. In a recent study, Kim et al. made an initiative to measure two ions, Na^+ and K^+ , by means of an electrode. They designed the reference electrode based on reduced fluorinated graphene oxide, and used indium tin oxide (ITO) as a thin gate layer. Using this sensor, they detected Na^+ and K^+ ions in human urine with high sensitivity [78]. Also, in another interesting study Hyun and Cho used a K^+ selective membrane on a thin layer of amorphous indium gallium zinc oxide coplanar gate to measure K^+ concentration. This ISFET-based sensor had excellent selectivity. The results of K^+ including the solution and the solution containing other ions (in the absence of K^+) were completely different [79].

Megat Hasnan et al. used poly (3,4-ethylene dioxythiophene): poly (styrene sulfonate) composite thin layer with Ti_2CTX MXenes

layered including bovine serum albumin, and graphene oxide, in an ISFET gate structure for chlorpyrifos detection. This composite layer had higher sensitivity for chlorpyrifos compared to thin films without MXene [80]. This study showed the importance of the correct thin film selection and the gate material used in an ISFET biosensor.

Graphene, as a two-dimensional material consisting only of carbon atoms in a hexagonal structure, has always been a good candidate for sensors [81–83]. In this regard, Alves et al. used a graphene-based ISFET biosensor to measure an antiviral protein inhibiting HIV, recombinant cyanovirin-N (rCV-N). They used the linker 1-pyrene butanoic acid succinimidyl ester (PBSE) to immobilize the antibody on the graphene gate electrode, through the primary and secondary amine groups of the antibody. This biosensor detected rCV-N in the range of 0.01 to 10 ng/ml and the detection limit was 0.45 pg/ml. The easy fixation of the linker on the electrode surface, the stability, and the reusability of this sensor were attributed to the graphene used in the gate terminal [84].

The importance of the ISFET sensors' gate materials, in addition to laboratory research, has also been considered in simulation-based studies. To improve the sensitivity of the ISFET-based sensor, Prakash et al. used Ta_2O_3 , SiO_2 , Al_2O_3 , and HfO_2 , in the role of the ISFET gate by COMSOL simulation, and

the ISFET with Ta₂O₃ gate had the highest sensitivity [85].

V. READOUT METHODS

The requirement for higher precision and greater integration of the front circuit and signal readout methods have led to a revolution in the design and application of biosensors based on ISFET. Measurement methods are classified into two types, single and differential measurements. In a single ISFET sensor measurement, two readout methods are involved to achieve continuous encoding. The simplest readout system for the reference electrode is the feedback mode. In this case, the ISFET sensor current is constant, and the pH of the solution changes the voltage feedback to the reference [41]. However, its inadequacy with the conventional reference electrode was the reason for replacing the feedback mode with the current mode. This technique is now widely used in front-end ISFET sensor configurations, including constant current readout (CCR), constant voltage readout, and current mode readout.

The Constant-Voltage, Constant-Current (CVCC) circuit depends on the constant source-drain voltage (VDS) and current identifiers. In the CVCC circuit, by loading a constant voltage between the source and drain of the ISFET, the change in pH is reflected in the changes in the source voltage [86] (Figure 4A). In addition, more pixel architectures have been proposed. The readout unit for the ISFET sensor array consists of three transistors and a single ISFET

device: transistor P1 acts as the load by providing constant current, and transfer gate P3/N1 acts as the readout for each pixel [87] (Figure 4B). Another notable method is time-to-pH readout where the C0 capacitor is charged before detection and discharged during pH measurement. In this method, the discharge time depends on the drain-source current of the MN0 transistor, and therefore, on the pH of the solution. The N1 voltage depends on the pH, followed by the conversion of time to voltage, and its value is calculated by turning off the S0 switch after a certain period [43] (Figure 4C).

The differential measurements in the ISFET sensors' signal readout reduces the common-mode signal, noise, and drift [86]. Figure 4D shows the ISFET sensor differential readout system including an ISFET amplifier and a differential amplifier. In the study by Wong et al. a reference ISFET sensor was immersed in solutions of a specified value, and the output signal of the difference between the two ISFET amplifiers was represented by the output signal. The pH of the desired analyte was then calculated, and the shift that occurred in both ISFET sensors was removed in the readout signal. The use of an ideal reference electrode is essential because the differential sensor allows for the elimination of the common-mode voltage between the two sensors, noise reduction, minimizing drift effects and temperature differences [86]. Also, other innovations have been made in this type of reading method for ISFET biosensors [43].

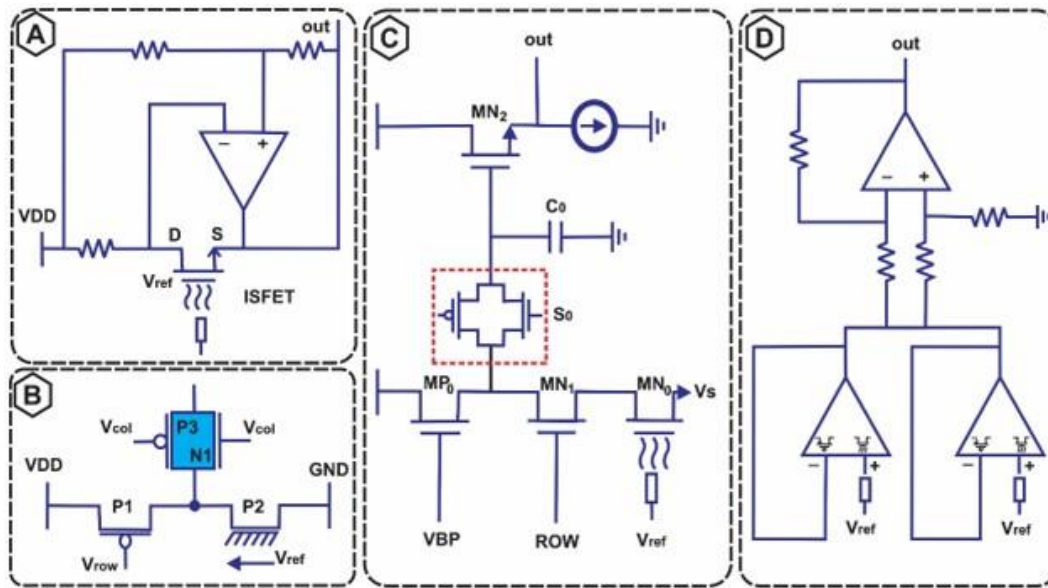

Fig. 4 ISFET sensors readout methods; (A) Source-drain follower circuit; (B) Standard pixel readout; (C) Time-to-pH voltage readout system; and (D) Differential amplifier readout system.

VI. BIOSENSING APPLICATIONS

The intrinsic properties of the gate materials account for the strong response of the ISFET sensors to certain ions. In addition, the interactions between the ISFET gate and biomolecules affect the electrical output of the

ISFET. Therefore, ISFET-based sensors are used to detect biomolecules and ions [88]. In Table 4, some recent research in the field of using ISFET biosensors are given. Recent advances in ISFET biosensing are presented in more detail in the following sections.

TABLE 4. SOME RECENT STUDIES OF BIOSENSORS BASED ON ISFET.

Transistor	Research topic	Ref.
ISFET	Real-time detection of integrated RNA in men with prostate cancer.	[89]
ISFET	Detection of antibodies against HLA ^a and MICA ^b .	[77]
F ^c -rGO RE-ISFE	Using F-rGO RE in ISFET structure to detect potassium and sodium ions in urine.	[78]
JF-ED-TFET ^d	Simulation of a JF-ED-TFET for label-free biosensing applications.	[90]
FET	Development of a biosensor platform based on IGZO planar thin film gate coplanar transistor for selective detection of K ⁺ .	[79]
ISFET	Sensitive and fast detection of SARS-CoV-2, without Debye length limitation.	[91]
Si NW ^e -FET	Application of Si NW-FET biosensor with graded channel gate for label-free biomolecule detection.	[92]
DG ^f -ISFETs	Application of DG-ISFETs for continuous pH measurement with gate layer capacitance beyond Nernst.	[93]
ISFET	Using a 3x2 differential ISFET integrated pixel array for pH measurement.	[94]

a, Human leukocyte antigen; b, Major histocompatibility complex associated with class I; c, Fluorinated; d, Junction-free tunneling field-effect-based biosensor; e, Silicon nanowire; and f, Double-gate

A. Ions

For the first time in 1970 Piet Bergveld used ISFET sensors with a SiO₂ gate to detect Cl⁻ and Na⁺ around nerves [14]. He replaced the classic MOSFET metal gate ISFET with a hybrid ion/electrolyte/RE selective film module and used the resulting device for ion sensing. After this study, the ISFET ion sensor received the scientific community attention. Since then, the ISFET ion sensors have been introduced to the public for performance studies.

ISFET is commonly used for pH sensing. Grasta et al. used ISFET to detect the presence of chloride ions in sweat [95]. This study was done to diagnose cystic fibrosis. They used empirical reality modeling. Gate oxides (HfO₂) in a chemical reaction with electrolyte solution, anions (Cl⁻) directly react with hydroxyl groups

and replace surface protons. The Cl⁻ detection limit of the designed device was 4 μmol/m³. They also investigated the effect of oxide width on device performance. In Figure 5, HfO₂ is considered as an insulator, and the changes in the dependence of the drain-source current (I_{DS}) on the drain-source voltage (V_{DS}) depend on the four values of d_{HfO₂}. In addition to pH sensing (Table 5), ISFET sensors sense various ions such as Na⁺ [78], Cu²⁺ [96], and K⁺ [97], by using different sensitive membranes loaded on modified channel materials and gates. Ions are critical analytes in healthcare and medicine. For example, in a recent study by Annabella la et al., they used a NaCl measuring ISFET device with HfO₂ to diagnose and analyze cystic fibrosis. The selective polyvinyl chloride membrane increased the sensibility of the ISFET to other ions [98].

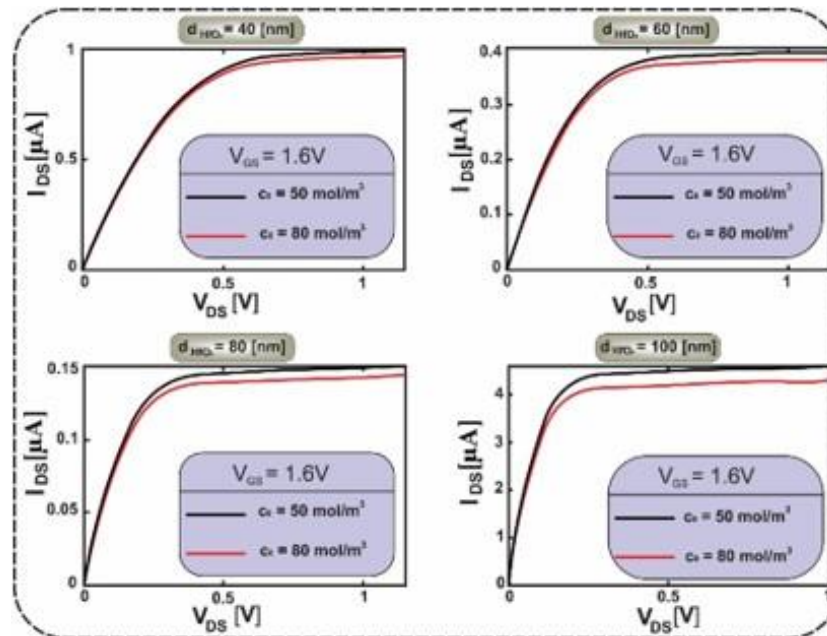

Fig. 2 Investigating the effect of HfO₂ thickness on drain-source current (I_{DS}) versus drain-source voltage (V_{DS}) for two different amounts of Cl⁻ [95].

TABLE 5. AN OVERVIEW OF SOME STUDIES CONDUCTED IN THE FIELD OF pH DETECTION WITH ISFET SENSORS.

Basis	Target	Linear range	Year	Ref.
Al ₂ O ₃ ISFET	pH detection	1 – 12	2004	[99]
pH-ISFETs	potato glycoalkaloids analysis	-	2005	[100]
pH-MFGFET	pH detection	1 – 13	2008	[101]
SOI-DG ^a ISFETs	pH detection	3 – 11	2013	[102]
Si ₃ N ₄ /SiO ₂ ISFET	pH detection	2 – 12	2013	[103]
DG-CNT-ISFET ^b	pH detection	5 – 9	2019	[104]
In ₂ O ₃ nano gate ISFET	pH detection to determine the concentration of biomolecules	6 – 10	2020	[105]
UT ^c and TiO ₂ gate ISFET	pH detection	1 – 12	2020	[106]
SiO ₂ /Ta ₂ O ₅ ISFET ^d	EG- pH detection	3 – 10	2020	[107]
Si NW DG ^e -ISFET	pH detection	~3 – 10	2021	[108]
ISFET	pH detection	5 – 11	2022	[109]

a, Silicon-on-insulator dual-gate; b, Dual-gate carbon nanotube ISFET; c, Ultrathin body; d, Extended-gate ISFET; and e, Silicon nanowire dual gate.

B. DNA

In accordance with the great importance of accurate detection of nucleic acids in the design and discovery of drugs, diagnosis of various types of cancers and genetic diseases, optical, magnetic, electrochemical, and enzyme assay methods have been developed [110]. The advantage of these methods is high sensitivity and low detection limits, but they have shortcomings such as being expensive and large measuring instruments, complex measuring circuits, harmful labels, and time-consuming preparations [111]. To resolve this problem, the ISFET method is an excellent candidate. Currently, ISFET-based DNA sensing is performed with two mechanisms:

- Enzymatic reactions based on DNA polymerase, which lead to the production of H⁺ and affect the surface charge distribution of the ISFET gate.

- The other is based on DNA strand hybridization leading to the generation of negative charges that affect the surface charge distribution of the ISFET gate and causes a change in the electrical output of the ISFET [112].

ISFET DNA sensors have high sensitivity, fast detection, low detection limit, high sensitivity, a simple manufacturing process, low cost, and good characteristics. Therefore, many research groups have become interested in their use (Table 6). Based on the advantages, many studies on ISFET-based DNA sensors have been developed in recent years. For example, Mahdavi *et al.* used 3-aminopropyltriethoxysilane (APTES) to silanize the ISFET gate and immobilize DNA probes on the gate, to make a sensitive DNA sensor. The steps and patterns of the expected data in different stages of the experiment are

shown in Figure 6. The sensors were tested during fabrication with 0-5 voltages for both the drain source and the voltage electrode. The reference electrode was Ag/AgCl. Steps 1-7 represented the possible loads for each stage of their experiment and the expected changes in the source-drain current were plotted. DNA hybridization was done in step 5 and the

changes in current were proportional to it. This sensor produced an output signal of about 500 mV in the presence of a DNA solution at a concentration of 10 pM. The limit of detection (LOD) of DNA can be 1 fM and the corresponding DNA sensitivity is 50 $\mu\text{V}/\text{fM}$ [113].

TABLE 6. SOME CASES OF ISFET-BASED SENSORS IN DNA DETECTION.

Basis	Aim	LOD (μM)	Linear range (μM)	Year	Ref.
CMOS-ISFET ^a	Real-time DNA hybridization	0.2	-	2016	[114]
DG-NR-ISFET ^b	CorDNA ^c	5×10^{-5}	$10 \times 10^{-3} - 1$	2018	[115]
CMOS-ISFET	DNA molecules	1×10^{-5}	$1 \times 10^{-12} - 1$	2020	[116]
EGFET ^d	Cor DNA molecules	1×10^{-2}	$1 \times 10^{-3} - 1$	2020	[117]
CMOS-ISFET	Direct DNA hybridization	1×10^{-5}	$1 \times 10^{-5} - 1 \times 10^{-3}$	2020	[118]

a, Complementary metal-oxide semiconductor-ISFET; b, Dual-gate nanoribbon-based ISFET; c, Cordyceps sinensis's DNA; and d, Extended-Gate FET.

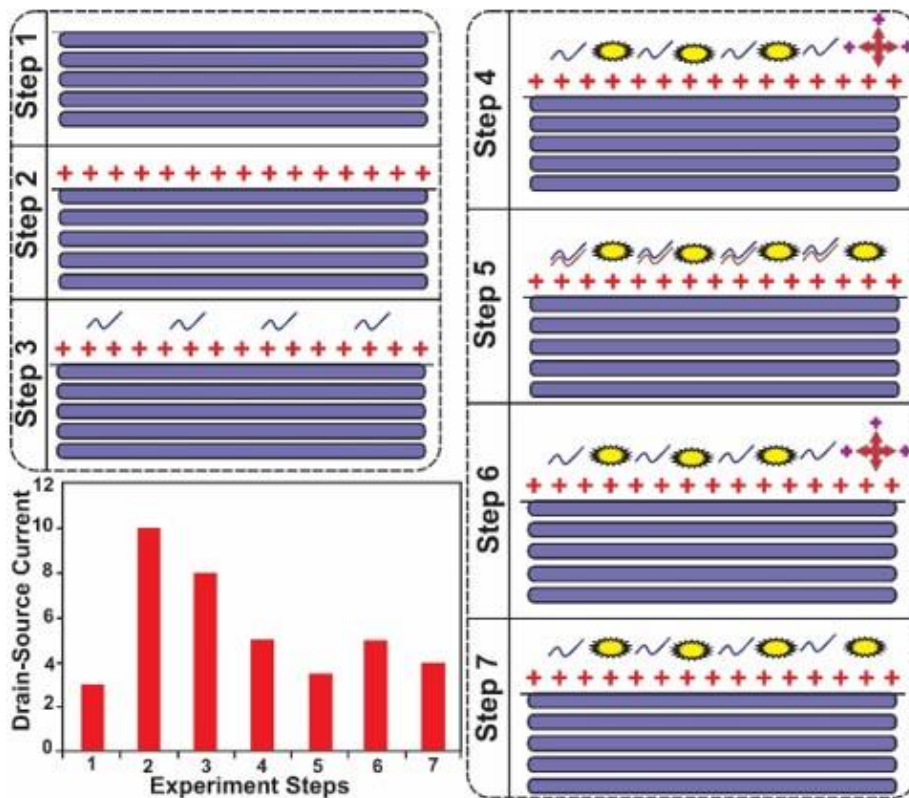

Fig. 6 Test steps pattern and expected data in different test steps. Positive charges are due to APTES entering the surface. The yellow shape of sodium dodecyl sulfate (SDS) is negatively charged, and the red crosses are EDTA molecules [113].

The generation of pyrophosphates during DNA amplification lowers the pH, and this property has been used for silicon based ISFET sensors for DNA detection. However, graphenes are very suitable because of their surface-to-volume ratio. Graphene (π - π bonds) is used for non-covalent stabilization of single-stranded DNA primers because it does not absorb double-stranded DNA. In this regard, Ganguli et al. used Bst polymerase (in silico designed homolog of *Bacillus stearothermophilus* DNA Polymerase I) in a loop-mediated isothermal amplification (LAMP) reaction in the presence of target-specific primers and crumpled graphene field effect transistors (GFET) to detect amplification by primer reduction assay. They were able to detect the end point of the amplification reaction with initial concentrations of only 8×10^{-21} M of *E. coli* DNA [119]. ISFET goes beyond the detection of nucleic acids and by entering DNA sequencing technology, it provides important data for gene detection and gene therapy. ISFET sensors are also designed to detect DNA base pairing, which can be useful in DNA sequencing systems [120].

C. Enzyme-based sensors

Enzyme-based ISFET sensors are achieved by immobilizing enzymes on the gate surface of ISFET to detect enzyme substrates [121]. As a result of enzymatic reactions, the charge

distribution on the gate surface changes, which can be detected by the electrical output. Accordingly, enzyme-based ISFET sensors (ENFETs) have been used to detect many biological analytes such as glucose, penicillin, cholesterol, urea, and dopamine [122]. Due to the choice of the small size of ISFET sensors, high adaptability, fast response of enzymatic reactions, high sensitivity and the need for small sample volume have made ENFET sensors very popular.

Bhatt et al. developed an acetylcholinesterase (AChE) biosensor based on an electrolyte carbon nanotube field effect transistor. The enzyme was immobilized on a flat gold gate electrode with a linker using 3-mercaptopropionic acid. They used least-squares curve fitting and obtained a sensitivity of 5.7 $\mu\text{A}/\text{decade}$. The real-time response was in the concentration range of 1×10^{-12} – 1×10^{-3} M (constantly applied biases (V_{DS}) = -0.2 V and (V_{GS}) = -0.8 V) (Figure 8A). This test gave a proportional response to different analyte concentrations, while it was not sensitive to glycine and serine interferences (Figure 8B). This sensor had a high capability in real samples, and as a result it was very resistant and flexible [123]. In general, the design of ISFET sensors based on cholinesterases is of significant interest to researchers.

TABLE 7. SOME STUDIES ON THE APPLICATION OF CHOLINESTERASES IN FET BIOSENSORS.

Transistor	Gate enzyme	Detection substance	LOD (μM)	Linear range (μM)	Year	Ref.
SGGT ^a	AChE ^b	Organophosphorus pesticide	0.01	0.3 – 3	2021	[124]
ISFET	AChE	Indole alkaloids	0.5 $\mu\text{g}/\text{ml}$	2 – 15 $\mu\text{g}/\text{ml}$	2022	[125]
rGO ^c FET	AChE	ACh ^d	2.3	5 – 1000	2020	[126]
rGO FET	AChE	ACh	1 μM	$1 - 1 \times 10^4$	2018	[127]
ISFET	Butyryl cholinesterase	Glycoalkaloids	-	0.03 – 5	2006	[128]

a, solution-gated graphene transistor; b, Acetylcholinesterase; c, Reduced-graphene-oxide; and d, Acetylcholine.

Providing portable sensors requires high flexibility and a flexible substrate. In this regard, Kwak et al. developed a chemical vapor deposition-grown graphene-based FET for glucose sensing. Chemical vapor deposition-grown graphene was functionalized with glucose oxidase enzyme linker molecules. The graphene-based FET sensor had bipolar transmission characteristics. By measuring the Dirac point shift and drain-source differential current, the developed FET sensor detected glucose levels in the range of 3.3 to 10.9 mM. This corresponds to the reference range of medical examinations, and the sensor was very flexible [129]. In another study, Wang et al. developed a FET-based glucose sensor with a bimetallic nickel-copper metal-organic framework (Ni/Cu-MOFs) as its channel layers. They used glutaraldehyde as a linker to immobilize glucose oxidase. The synergistic effect of Ni and Cu ions in MOFs caused the appropriate field effect on glucose. This sensor showed a linear relationship in the range of $1 - 2 \times 10^4 \mu\text{M}$, a lower detection limit of $0.51 \mu\text{M}$,

and a sensitivity of $26.05 \mu\text{Acm}^{-2}\text{mM}^{-1}$. This sensor had high specificity, reasonable short-term stability, excellent repeatability, and fast response time [130]. In a study based on the glucose oxidase-like activity of nanozymes, Farahmandpour et al. recently developed a non-enzymatic FET sensor for glucose detection. They synthesized CuO hollow spheres decorated with reduced graphene oxide (rGO). These synthesized nanostructured hollow microspheres (rGO/CuO-NHS) were immobilized on a flexible PET substrate between interdigitated electrodes as the channel of a back gate transistor. The high surface-to-volume ratio of the nanostructured shell and the selective porous hollow spheres of CuO along with the high conductivity of rGO became the cause of glucose oxidation with a low detection limit of 1 nM and sensitivity of $600 \mu\text{A} \mu\text{M}^{-1}$. In addition, the flexible glucose sensor had high reproducibility (Figure 8C), repeatability (Figure 8D), and good stability (Figure 8E) [131]. Table 8 lists some studies on the use of enzymes for glucose detection.

TABLE 8. SOME CASES OF GLUCOSE OXIDASE /GLUCOSE OXIDASE MIMICS-BASED FET BIOSENSORS.

Transistor	Gate enzyme	LOD (μM)	Linear range (μM)	Year	Ref.
FET	Ag NPs as an enzyme mimic	-	0.1 – 0.25	2020	[132]
ZnO/CuO-NHS ^a FET	Glucose oxidase	0.03	-	2023	[133]
MoS ₂ FET	Glucose oxidase	0.3	$0.3 - 3 \times 10^4$	2018	[59]
EGFET	Glucose oxidase	0.001 mg/mL	0.1 – 1 mg/mL	2020	[134]
Silk fibroin-encapsulated graphene FET	Glucose oxidase	100	$100 - 1 \times 10^4$	2014	[121]
rGO/C-PPy NT FET ^b		0.001	0.001 – 100	2015	[135]
EGFET	Ga ₂ O ₃ as an enzyme mimic	20	-	2022	[136]

FET	Polyaniline/glucose oxidase	-	$0 - 9 \times 10^3$	2004	[137]
FET	CPPN ^d - Glucose oxidase	500	$2 \times 10^3 - 2 \times 10^4$	2008	[138]
FET	Glucose oxidase	100	$< 1 \times 10^4$	2010	[139]
ISFET	PSW ^e	3.2×10^{-5}	$10^{-4} - 10^{+3}$	2011	[140]
ISFET	Glucose oxidase	25	$50 - 1.8 \times 10^3$	2004	[141]

a nanostructure hollow spheres; b, Extended gate FET; c, Reduced graphene oxide-carboxylated polypyrrole nanotube FET; d, Carboxylated polypyrrole nanotube; and e, Polysilicon wire.

Peroxidases are used as a secondary reaction during assays of various enzymatic processes such as oxidation and immunoassays. Use of ISFET sensors instead of expensive spectrophotometric methods is a suitable option. For example, Tomari *et al.* used the signal accumulation of an ion-sensitive field effect transistor (SA-ISFET) sensor to measure sarcosine, lactic acid, uric acid and glucose, and detect *Escherichia coli* (using a peroxidase-labeled antibody) [142]. In another study, Maria *et al.* used horseradish peroxidase (HRP)

as a label to determine the interaction between thrombin and its aptamer on the surface of ISFET. The complementary sDNA probe containing HRP was replaced by the immobilized aptamer (sDNA) with thrombin, and the HRP activity was assayed. This biosensor detected thrombin with a low detection limit of 7×10^{-7} M [143]. Table 19 lists some studies based on peroxidases in FET sensors.

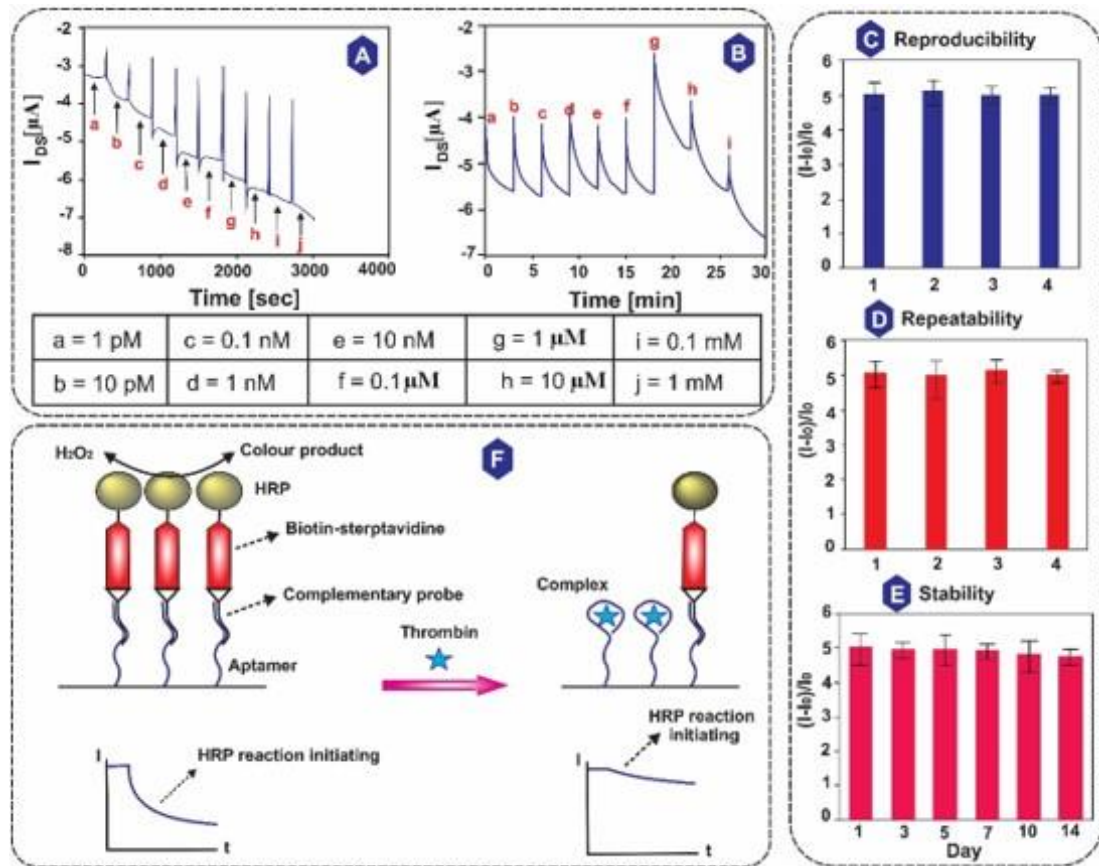

Fig. 7 Real-time sensor response of different acetylcholine concentrations. (D) Selectivity of the sensor for acetylcholine in the presence of serine and glycine (description in text) [123]; (C) Reproducibility for 4 glucose samples with a concentration of 5 nM glucose for the sensor; (D) Repeatability for different sensors with the same manufacturing method in the presence of 5 nM glucose; (E) stability test of the sensor that retained 93% of its activity after 14 days [131]; and (F) Schematic of thrombin displacement and identification [143].

TABLE 9. SOME STUDIES ON THE APPLICATION OF FET SENSORS BASED ON PEROXIDASE ENZYMES/ PEROXIDASE MIMICS.

Transistor	Enzyme	Substrate	LOD (μM)	Linear range (μM)	Year	Ref.
ISFET	HRP ^a	H ₂ O ₂	0.5	Up to thousands	1994	[144]
ISFET	β'-glucosidase, mandelonitrile lyase and HRP	Amygdalin	-	100 – 300	1998	[145]
PVPy ^b -ISFET	HRP	Cyanide	-	0.1 – 10	1998	[146]
ISFET	HRP, glucose oxidase, and urease	Ascorbic acids	-	250 – 2 × 10 ³	1998	[147]
		Citric acids		0.1 – 10		
ISFET	Peroxidase	Herbicide simazine	1.25 ng ml ⁻¹	5–175 ng ml ⁻¹	2000	[148]

GFET ^c	HRP, glucose oxidase	Glucose	0.2	1 – 10 ⁴	2021	[149]
rGO FET	MoS ₂	Releasing H ₂ O ₂ from cancer cell	10 ⁻⁶	-	2019	[60]

a, Horseradish peroxidase; b, Poly(4-vinylpyridine-co-styrene); and c, Graphene field-effect transistor.

Other enzymes are also used in the design of FET-based sensors. For example, Abdul Barik et al. in 2014 used a cholesterol oxidase-potassium-doped CNT-FET to detect cholesterol. The type P-graphene was the electrochemical as a substrate on the ITO glass, and used the N-type graphene sediment. ZrO₂ in the channel area played a gate insulation role. The K/PPy/CNT composite formed the sensor layer at the top of the ZrO₂ layer. They moved cholesterol oxidase on the K/PPy/CNT membrane with physical absorption techniques. The linear diagnosis range was 0.5 to 20 mM. The sensitivity of this FET was ~ 400 μ A/mM/mm² (R ~ 0.998). This sensor had Michaelis-Menten constant (K_m) and the detection limit of 2.5 and 1.4 mM, respectively. Another notable point was the very low interference of glucose, urea, and uric acid in the results [150] (please see more examples in Table 10).

Although the use of nanozymes in FET-based biosensors has not yet reached maturity, significant number of studies have been performed. MXenes are two-dimensional materials with hydrophilicity, high conductivity, and high surface area, and thus are attractive for the design of biosensors. In this regard, Hasnsn et al. used Ti₂CTx MXene structures in an ion-sensitive field effect transistor (ISFET) to detect chlorpyrifos (Cpy). The use of a thin layer composite poly (3,4-ethylene dioxythiophene)-poly (styrene sulfonate) layer with layered pieces of Ti₂CTx MXenes with graphene oxide and bovine serum albumin (BSA) resulted in the reduction of the minimum electrical threshold voltage Cpy by -0.1 V (the voltage of using TiO₂ which is -1.5 V). Considering the potential of Ti₂CTx MXene-BSA two-dimensional composite, the detection of CPY with an enzyme-free sensor was available [80].

TABLE 10. APPLICATION OF OTHER ENZYMES IN THE DESIGN OF ISFET BIOSENSORS.

Transistor	Enzyme	Substrate	LOD (μ M)	Linear range (μ M)	Year	Ref.
ISFET	Creatinine deiminase/ urease	Ammonia	20	20 – 1000	2005	[151]
ISFET	Creatinine deiminase	Ammonia	10	0 – 5000	1998	[152]
ISFET	Creatinine amidohydrolase	API ^a	-	-	2016	[153]
CNT ^b -ISFET	Laccase	ABTS ^c	3	up to 300	2020	[154]
SGGT ^d	Lactate oxidase	lactic acid	0.3	3 – 300	2019	[155]
ISFET	Carbapenemase	Imipenem	0.1	-	2021	[156]
CNT-ISFET	Cholesterol oxidase	Cholesterol	230	500 – 25 × 10 ³	2021	[157]
EGFET	Uricase	Uric acid	0.082 mg/dL	2 – 7 mg/dL	2021	[158]

FET	Tyrosinase	Dopamine	0.003	1 – 120	2021	[159]
ISFET	DNA aptamer / alkaline phosphatase	COVID-19 spike proteins	100 copies/ μ L in 10 min	-	2023	[91]
EGFET	Uricase	Uric acid	-	1-30 mg/dL	2021	[160]
ISFET	Alkaline phosphatase	Interleukin-5	~1 ng/mL	1 pg/mL - 10 ng/mL	2015	[161]

a, Active pharmaceutical ingredients; b, Carbon nanotube; c, 2, 2-azino-bis 3-ethylbenzothiazoline-6-sulphonic acid; and d, Solution-gated graphene transistors.

D. Antigen-antibody detection

Antigen-related immune detection is very important for the diagnosis and prevention of diseases such as immune diseases, tuberculosis, and various types of cancer. The main advantage of ISFET is the very little work potential and neutrality in the antigen-antibody interactions [13]. Many studies have been done on the reusability and sensitivity of these sensors. The multi-layered gateway structure is the most used strategy to improve sensitivity. For example, Kutova et al. have developed a multilayer gate from CeO₂/SiO₂ for ultrasensitive C protein antigen. The sensor was very practical in PBS and human serum to predict inflammation in vivo and diagnose acute diseases [162]. Another important point is to build an ISFET gate with different structures. In this regard, Lee et al. improved performance for antigen diagnosis from hepatitis B levels based on the structure of two gates with an excellent detection limit of 22.5 fg/ml [47]. In addition, the use of nanomaterials on the ISFET gate to increase sensitivity due to the high surface-to-volume ratio can be promising. For example, Kuznetsov et al. used nanoribbons to detect prostate-specific antigens with a limit of detection of 0.4 pg/ml [163]. Finally, it is noteworthy that researchers have not neglected the reusability of the ISFET-based antigen-antibody interaction sensors. Research has been conducted to produce reusable ISFET-based sensors [164].

VII. CONCLUSION AND PERSPECTIVE

The design and improvement of biosensors have always been attractive and extensive research has been conducted in this field. In this regard, ISFET sensors have also been constantly improved. Here we reviewed the working principles and methods of gate operation in ISFET-based biosensors in various studies. ISFETs are excellent sensors for biomolecules such as proteins, DNA, ions, bioanalyses, and biomarkers due to their high sensitivity, reusability, real-time detections, waterproof properties, and all-solids. Of course, these advantages do not mean the maturity of the manufacturing process, use, and commercial development of ISFET-based biosensors, and our perspective is mentioned below.

Debye screening at high concentrations of ionic solutions (protecting analytes from contacting the gate) has slowed the development of ISFET biosensors. Analytes smaller and comparable to Debye are not detected due to the high ionic strength at a distance smaller than λ , at the electrolyte-gate interface, especially for small molecule analytes whose size is comparable and smaller than Debye. To overcome this drawback, probes can be used for connection or nanoparticles in different forms and shapes can be used as the sensor immobilized layer.

One of the important current issues is the use of multiple measurement techniques in one sensor. For this purpose, multiple ISFET sensors can be incorporated into one chip.

However, the miniaturization process as well as the number of wires required for switching on and off will be large. In this case the sensors must work in shifts, and will be expensive in terms of integration cost. However, it is possible to use the light-receiving address system for ISFET. Efforts should also be made to increase the number of analytes measured in an ISFET.

As with the classical behavior of MOSFET sensors, increasing the thickness decreases the sensitivity of the device. The use of an ISFET device for the detection of other biomarkers in readily available biological fluids, consistent with medical applications, is still nascent. Therefore, more efforts should be made to miniaturize more ISFET sensors. Of course, it should be noted that by reducing the thickness of layers and downsizing, the durability and stability of the device is not affected.

One of the problems in the construction and design of most biosensors is the low stability of immobilized biomolecules on the substrate. ISFET sensors are no exception to this rule. In this regard, we predict that in the future research in this field should focus more on the use of nanozymes and nanostructures in the construction and development of ISFET sensors. This will not only provide more stability, but also resolve all the deficiencies in the early generations of ISFET sensors.

REFERENCES

- [1] A. Shinde, K. Illath, U. Kasiviswanathan, S. Nagabooshanam, P. Gupta, K. Dey, et al. "Recent Advances of Biosensor-Integrated Organ-on-a-Chip Technologies for Diagnostics and Therapeutics," *Analytical Chemistry*, vol. 95, pp. 3121-3146, 2023.
- [2] F. Ghasemi and A. Salimi, "Advances in 2D Based Field Effect Transistors as Biosensing Platforms: From Principle to Biomedical Applications," *Microchemical Journal*, vol.187 pp.108432, 2023.
- [3] K.S. Singh, P. Gupta, M. Rajoriya, N. Kumari, and A. Muskan, "Study of Tunnel Field Effect Transistors for Biosensing Applications: A Review," *International Conference on Computing, Communication, and Intelligent Systems (ICCCIS): IEEE*, vol. 144, pp. 1-5, 2022.
- [4] R. Jalili, A. Khataee, M-R. Rashidi, and A. Razmjou, "Detection of penicillin G residues in milk based on dual-emission carbon dots and molecularly imprinted polymers," *Food chemistry*, vol. 314, pp. 126172, 2020.
- [5] R. Shiwaku, H. Matsui, K. Nagamine, M. Uematsu, T. Mano, and Y. Maruyama, et al, "A printed organic amplification system for wearable potentiometric electrochemical sensors," *Scientific reports*, vol. 8, pp. 3922 (1-8), 2018.
- [6] M. Adampourezare, G. Dehghan, M. Hasanzadeh, and M-AH. Feizi, "Application of lateral flow and microfluidic bio-assay and biosensing towards identification of DNA-methylation and cancer detection: Recent progress and challenges in biomedicine," *Biomedicine & Pharmacotherapy*, vol. 141, pp. 111845, 2021.
- [7] H. Sohrabi, MR. Majidi, O. Arbabzadeh, P. Khaaki, S. Pourmohammad, A. Khataee, et al, "Recent advances in the highly sensitive determination of zearalenone residues in water and environmental resources with electrochemical biosensors," *Environmental Research*, vol. 204, pp. 112082, 2022.
- [8] T. Kuno, K. Niitsu, and K. Nakazato, "Amperometric electrochemical sensor array for on-chip simultaneous imaging," *Japanese Journal of Applied Physics*, vol.53, pp. 04EL1, 2014.
- [9] P. Bertinello and R.J. Forster, "Nanostructured materials for electrochemiluminescence (ECL)-based detection methods: recent advances and future perspectives," *Biosensors and Bioelectronics*, vol. 24, pp. 3191-3200, 2009.
- [10] S. Rashtbari, G. Dehghan, S. Khataee, M. Amini, and A. Khataee, "Dual enzymes-mimic activity of nanolayered manganese-calcium oxide for fluorometric determination of

- metformin,” *Chemosphere*, vol. 291, pp. 133063, 2022.
- [11] S. Rashtbari, G. Dehghan, and M. Amini, “An ultrasensitive label-free colorimetric biosensor for the detection of glucose based on glucose oxidase-like activity of nanolayered manganese-calcium oxide,” *Analytica chimica acta*, vol. 1110, pp. 98-108, 2020.
- [12] B.A. Prabowo, A. Purwidyantri, and K-C. Liu, “Surface plasmon resonance optical sensor: A review on light source technology,” *Biosensors*, vol. 8, pp. 1-28, 2018.
- [13] S. Cao, P. Sun, G. Xiao, Q. Tang, X. Sun, H. Zhao, Sh. Zhao, H. Lu, and Z. Yue, “ISFET-based sensors for (bio) chemical applications: A review,” *Electrochemical Science Advances*, vol. 3, pp. e2100207 (1-25), 2022.
- [14] P. Bergveld, “Development of an ion-sensitive solid-state device for neurophysiological measurements,” *IEEE Transactions on biomedical engineering*, vol. 17, pp. 70-71, 1970.
- [15] Y. Su, W. Hsu, and C.T. Lin, “Review field effect transistor biosensing: devices and clinical applications,” *ECS J Solid State Sci Technol*, vol.7, pp. Q3196 (1-7), 2018.
- [16] W-S. Kao, Y-W. Hung, and C-H. Lin, “Solid-State Sensor Chip Produced with Single Laser Engraving for Urine Acidity and Total Dissolved Ion Detections,” *ECS Journal of Solid State Science and Technology*, vol. 9, pp. 115016, 2020.
- [17] J.T. Smith, S.S. Shah, M. Goryll, JR. Stowell, and D.R. Allee, “Flexible ISFET biosensor using IGZO metal oxide TFTs and an ITO sensing layer,” *IEEE Sensors Journal*, Vol. 14, pp. 937-938, 2013.
- [18] T. Wadhwa, D. Kakkar, G. Wadhwa, and B. Raj, “Recent advances and progress in development of the field effect transistor biosensor: A review,” *Journal of Electronic Materials*, vol. 48, pp. 7635-7646, 2019.
- [19] A.M. Dinar, A.M. Zain, and F. Salehuddin, “Utilizing of CMOS ISFET sensors in DNA applications detection: A systematic review,” *Jour Adv Res Dyn Control Syst*. Vol. 10, pp. 569-583, 2018.
- [20] L. Keeble, N. Moser, J. Rodriguez-Manzano, and P. Georgiou, “ISFET-based sensing and electric field actuation of DNA for on-chip detection: A review,” *IEEE Sensors Journal*, vol. 20, pp. 11044-11065, 2020.
- [21] Y-C. Syu, W-E. Hsu, and C-T. Lin, “Field-effect transistor biosensing: Devices and clinical applications,” *ECS Journal of Solid State Science and Technology*, vol. 7, pp. Q3196, 2018.
- [22] M. Wróblewska, “Miniaturized multiplexed bipotentiostat for field-effect transistor based biosensing: Katedra,” *Biotechnologii Medycznej*, 2023.
- [23] J.E. Lilienfeld and O. Heil, *Transistor efek-medan. System.800:000*.
- [24] W. Shockley, “A unipolar field-effect transistor,” *Proceedings of the IRE*. Vol. 40, pp. 1365-1376, 1952.
- [25] D. Kahng, “Silicon-silicon dioxide field induced surface devices,” *IRE Solid State Device Res Conf*1960.
- [26] J.C. Clark and C. Lyons, “Electrode systems for continuous monitoring in cardiovascular surgery,” *Annals of the New York Academy of sciences*, vol. 102, pp. 29-45, 1962.
- [27] P. Bergveld, “Development, operation, and application of the ion-sensitive field-effect transistor as a tool for electrophysiology,” *IEEE Transactions on Biomedical Engineering*, vol. , pp. 342-351, 1972.
- [28] K. Lundström, M. Shivaraman, and C. Svensson. “A hydrogen-sensitive Pd-gate MOS transistor,” *Journal of Applied Physics*, vol.46, pp. 3876-3881, 1975.
- [29] S. Caras and J. Janata. “Field effect transistor sensitive to penicillin,” *Analytical chemistry*, vol. 52, pp. 1935-1937, 1980.
- [30] L. Bousse, De. Rooij NF, and P. Bergveld, “Operation of chemically sensitive field-effect sensors as a function of the insulator-electrolyte interface,” *IEEE Transactions on Electron Devices*, vol. 30, pp. 1263-1270, 1983.

- [31] J-i. Anzai, T. KUSANO, T. OSA, H. NAKAJIMA, T. MATSUO, "Urea sensor based on ion sensitive field effect transistor coated with cross-linked urease-albumin membrane," *Bunseki Kagaku*, vol. 33, pp. E131-E136, 1984.
- [32] Y. Miyahara, T. Moriizumi, and K. Ichimura, "Integrated enzyme FETs for simultaneous detections of urea and glucose," *Sensors and Actuators*, vol. 7, pp. 1-10, 1985.
- [33] B.H. van der Schoot and P. Bergveld, "ISFET based enzyme sensors," *Biosensors*, vol. 3, pp. 161-86, 1987.
- [34] O. Boubriak, A. Soldatkin, N. Starodub, A. Sandrovsky, and A. El'skaya, "Determination of urea in blood serum by a urease biosensor based on an ion-sensitive field-effect transistor," *Sensors and Actuators B: Chemical*, vol. 27, pp. 429-431, 1995.
- [35] P.B. Lippa, L.J. Sokoll, and D.W. Chan, "Immunosensors—principles and applications to clinical chemistry," *Clinica chimica acta*, vol. 314, pp. 1-26, 2001.
- [36] D.E. Yates, S. Levine, and T.W. Healy, "Site-binding model of the electrical double layer at the oxide/water interface," *Journal of the Chemical Society, Faraday Transactions 1: Physical Chemistry in Condensed Phases*, vol. 70, pp. 1807-1818, 1974.
- [37] A.J. Bard, L.R. Faulkner *electrochemical methods*, Wiley, New York. 1980.
- [38] A. Van den Berg, P. Bergveld, D. Reinhoudt, and E. Sudhölter, "Sensitivity control of ISFETs by chemical surface modification," *Sensors and Actuators*, vol. 8, pp. 129-148, 1985.
- [39] M. Yuqing, G. Jianguo, and C. Jianrong, "Ion sensitive field effect transducer-based biosensors," *Biotechnology advances*, vol. 21, pp. 527-534, 2003.
- [40] A. Simonis, T. Krings, H. Lüth, J. Wang, and M.J. Schöning, "A hybrid thin-film pH sensor with integrated thick-film reference," *Sensors*, vol. 1, pp. 183-192, 2001.
- [41] P. Bergveld, "Thirty years of ISFETOLOGY: What happened in the past 30 years and what may happen in the next 30 years," *Sensors and Actuators B: Chemical*, vol. 88, pp. 1-20, 2003.
- [42] R. Datar and G. Bacher, "Influence of Gate Material, Geometry, and Temperature on ISFET Performance in pH Sensing Applications," *Silicon*, vol. 1, pp. 1-13, 2023.
- [43] X. Ma, R. Peng, W. Mao, Y. Lin, and H. Yu, "Recent advances in ion-sensitive field-effect transistors for biosensing applications," *Electrochemical Science Advances*, vol. , pp. e2100163, 2022.
- [44] S. Honda, M. Shiomi, T. Yamaguchi, Y. Fujita, T. Arie, S. Akita, et al. "Detachable Flexible ISFET-Based pH Sensor Array with a Flexible Connector," *Advanced Electronic Materials*, vol. 6, pp. 2000583, 2020.
- [45] J. Zhang, M. Rupakula, F. Bellando, E. Garcia Cordero, J. Longo, F. Wildhaber, et al. "Sweat biomarker sensor incorporating picowatt, three-dimensional extended metal gate ion sensitive field effect transistors," *Acs Sensors*, vol. 4, pp. 2039-2047, 2019.
- [46] H-J. Jang and W-J. Cho, "High performance silicon-on-insulator based ion-sensitive field-effect transistor using high-k stacked oxide sensing membrane," *Applied Physics Letters*, vol. 99, pp. 043703, 2011.
- [47] I-K. Lee, M. Jeun, H-J. Jang, W-J. Cho, and K. Lee, "A self-amplified transistor immunosensor under dual gate operation: highly sensitive detection of hepatitis B surface antigen," *Nanoscale*, vol. 7, pp. 16789-16797, 2015.
- [48] Y-H. Chang, Y-S. Lu, Y-L. Hong, S. Gwo, J.A. Yeh, "Highly sensitive pH sensing using an indium nitride ion-sensitive field-effect transistor," *IEEE Sensors Journal*, vol. 11, pp. 1157-1161, 2010.
- [49] M. Myers, FLM. Khir, A. Podolska, G.A. Umana-Membreno, B. Nener, M. Baker, et al. "Nitrate ion detection using AlGaIn/GaN heterostructure-based devices without a reference electrode," *Sensors and Actuators B: Chemical*, vol. 181, pp. 301-305, 2013.

- [50] H. Abe, M. Esashi, and T. Matsuo, "ISFET's using inorganic gate thin films. IEEE Transactions on Electron Devices," vol. 26, pp. 1939-1944, 1979.
- [51] J. Kwon, B-H. Lee, S-Y. Kim, J-Y. Park, H. Bae, Y-K. Choi, et al. "Nanoscale FET-based transduction toward sensitive extended-gate biosensors," ACS sensors, vol. 4, pp. 1724-1729, 2019.
- [52] R. Chaudhary, A. Sharma, S. Sinha, J. Yadav, R. Sharma, R. Mukhiya, et al. "Fabrication and characterisation of Al gate n-metal-oxide-semiconductor field-effect transistor, on-chip fabricated with silicon nitride ion-sensitive field-effect transistor," IET Computers & Digital Techniques, vol. 10, pp. 268-272, 2016.
- [53] P. Firek, M. Waskiewicz, B. Stonio, and J. Szmids, "Properties of AlN thin films deposited by means of magnetron sputtering for ISFET applications," Materials Science-Poland, vol. 33, pp. 669-676, 2015.
- [54] S. Nakata, T. Arie, S. Akita, K. Takei, "Wearable, flexible, and multifunctional healthcare device with an ISFET chemical sensor for simultaneous sweat pH and skin temperature monitoring," ACS sensors, vol. 2, pp. 443-448, 2017.
- [55] K. Singh, J-L. Her, B-S. Lou, S-T. Pang, and T-M. Pan, "An extended-gate FET-based pH sensor with an InZn x O y membrane fabricated on a flexible polyimide substrate at room temperature," IEEE Electron Device Letters, vol. 40, pp. 804-807, 2019.
- [56] Q. Zhang, HS. Majumdar, M. Kaisti, A. Prabhu, A. Ivaska, R. Österbacka, et al. "Surface functionalization of ion-sensitive floating-gate field-effect transistors with organic electronics," IEEE Transactions on Electron Devices, vol. 62, pp. 1291-1298, 2015.
- [57] L. Chen, H. Yu, J. Zhong, J. Wu, and W. Su, "Graphene based hybrid/composite for electron field emission: a review," Journal of Alloys and Compounds, vol. 749, pp. 60-84, 2018.
- [58] B. Radisavljevic, A. Radenovic, J. Brivio, V. Giacometti, and A. Kis, "Single-layer MoS₂ transistors," Nature nanotechnology, vol. 6, pp. 147-150, 2011.
- [59] J. Shan, J. Li, X. Chu, M. Xu, F. Jin, X. Wang, et al. "High sensitivity glucose detection at extremely low concentrations using a MoS₂-based field-effect transistor," RSC advances, vol. 8, pp. 7942-7948, 2018.
- [60] C. Zheng, X. Jin, Y. Li, J. Mei, Y. Sun, M. Xiao, et al. "Sensitive molybdenum disulfide based field effect transistor sensor for real-time monitoring of hydrogen peroxide," Scientific Reports, vol.9, pp. 759, 2019.
- [61] G. Zhou, J. Chang, H. Pu, K. Shi, S. Mao, X. Sui, et al. "Ultrasensitive mercury ion detection using DNA-functionalized molybdenum disulfide nanosheet/gold nanoparticle hybrid field-effect transistor device," Acs Sensors, vol.1, pp. 295-302, 2016.
- [62] J. Chang, H. Pu, SA. Wells, K. Shi, X. Guo, G. Zhou, et al. "Semi-quantitative design of black phosphorous field-effect transistor sensors for heavy metal ion detection in aqueous media," Molecular Systems Design & Engineering, vol.4, pp. 491-502, 2019.
- [63] Y. Chen, R. Ren, H. Pu, J. Chang, S. Mao, and J. Chen, "Field-effect transistor biosensors with two-dimensional black phosphorus nanosheets," Biosensors and Bioelectronics, vol. 89, pp. 505-510, 2017.
- [64] S. Kim, G. Lee, and J. Kim, "Chemical doping effects of gas molecules on black phosphorus field-effect transistors," ECS Journal of Solid State Science and Technology, vol. 7, pp. Q3065, 2018.
- [65] X. Li, Y. Lu, and Q. Liu, "Electrochemical and optical biosensors based on multifunctional MXene nanoplatfoms: Progress and prospects, Talanta, vol. 235, pp. 122726, 2021.
- [66] B. Xu, M. Zhu, W. Zhang, X. Zhen, Z. Pei, Q. Xue, et al. "Ulthathin MXene-micropattern-based field-effect transistor for probing neural activity," Advanced Materials, vol.28, pp. 3333-3339, 2016.
- [67] S. Hao, C. Liu, X. Chen, B. Zong, X. Wei, Q. Li, et al. "Ti₃C₂T_x MXene sensor for

- rapid Hg²⁺ analysis in high salinity environment,” *Journal of Hazardous Materials*, vol. 418, pp.126301, 2021.
- [68] C. Liu, S. Hao, X. Chen, B. Zong, and S. Mao, “High Anti-Interference Ti₃C₂T_x MXene Field-Effect-Transistor-Based Alkali Indicator,” *ACS applied materials & interfaces*, vol. 12, pp. 32970 (1-8), 2020.
- [69] Y. Li, Z. Peng, N.J. Holl, M.R. Hassan, J.M. Pappas, C. Wei, et al. “MXene–graphene field-effect transistor sensing of influenza virus and SARS-CoV-2,” *ACS omega*, vol.6, pp. 6643-6653, 2021.
- [70] S. Kim, T. Rim, K. Kim, U. Lee, E. Baek, H. Lee, et al. “Silicon nanowire ion sensitive field effect transistor with integrated Ag/AgCl electrode: pH sensing and noise characteristics,” *Analyst*, vol. 136, pp. 5012-5016, 2011.
- [71] Z. Dong and U.C. Wejinya, “Chalamalasetty SNS. Development of CNT-ISFET based pH sensing system using atomic force microscopy,” *Sensors and Actuators A: Physical*, vol. 173, pp. 293-301, 2012.
- [72] S. Ma, X. Li, Y-K. Lee, and A. Zhang, “Direct label-free protein detection in high ionic strength solution and human plasma using dual-gate nanoribbon-based ion-sensitive field-effect transistor biosensor,” *Biosensors and Bioelectronics*, vol. 117, pp. 276-282, 2018.
- [73] C-T. Lee and Y-S. Chiu, “Photoelectrochemical passivated ZnO-based nanorod structured glucose biosensors using gate-recessed AlGaN/GaN ion-sensitive field-effect-transistors,” *Sensors and Actuators B: Chemical*, vol. 210, pp. 756-761, 2015.
- [74] S-J. Young, L-T. Lai, and W-L. Tang, “Improving the performance of pH sensors with one-dimensional ZnO nanostructures,” *IEEE Sensors Journal*, vol. 19, pp. 10972(1-6), 2019.
- [75] M. Hajmirzaheydarali, M. Akbari, A. Shahsafi, S. Soleimani-Amiri, M. Sadeghipari, S. Mohajerzadeh, et al. “Ultra-high sensitivity DNA detection using nanorods incorporated ISFETs,” *IEEE Electron Device Letters*, vol. 37, pp. 663-666, 2016.
- [76] N. Abd-Alghafour, N.M. Ahmed, Z. Hassan, and M.A. Almessiere, “Hydrothermal synthesis and structural properties of V₂O₅ Nanoflowers at low temperatures,” *Journal of Physics: Conference Series*, Vol. 1083, pp. 012036, 2018.
- [77] T.Z.M.M.M. Min, S. Phanabamrung, W. Chaisriratanakul, A. Pankiew, A. Srisuwan, K. Chauyrod, et al. “Biosensors Based on Ion-Sensitive Field-Effect Transistors for HLA and MICA Antibody Detection in Kidney Transplantation,” *Molecules*, vol.27, pp. 6697, 2022.
- [78] D.H. Kim, H.S. Cho, J.H. Kim, D.A. Jo, H.G. Oh, B.K. Jang, et al. “The integration of reference electrode for ISFET ion sensors using fluorothiophenol-treated RGO,” *Biosensors*, vol.13, pp. 89, 2023.
- [79] T-H. Hyun and W-J. Cho, “High-Performance Potassium-Selective Biosensor Platform Based on Resistive Coupling of a-IGZO Coplanar-Gate Thin-Film Transistor,” *International Journal of Molecular Sciences*, vol. 24, pp. 6164, 2023.
- [80] M.M. Hasnan, G. Lim, N. Nayan, C. Soon, A.A. Halim, M. Ahmad, et al. “The investigation of chlorpyrifos (Cpy) detection of PEDOT: PSS-MXene (Ti₂CT X)-BSA-GO composite using P-ISFET reduction method,” *Polymer Bulletin*, vol. 80, pp. 1243-1264, 2023.
- [81] A.A. Noroozi and Y. Abdi, “A graphene/Si Schottky diode for the highly sensitive detection of protein,” *RSC advances*, vol.9, pp. 19613-19619, 2019.
- [82] A. Ghadakchi and Y. Abdi, “Reduced graphene oxide/silicon nanowire heterojunction for high sensitivity and broadband photodetector,” *IEEE Sensors Letters*, vol. 3, pp. 1-4, 2019.
- [83] A. Şenocak, E. Korkmaz, A. Khataee, and E. Demirbas, “A facile and synergetic strategy for electrochemical sensing of rutin antioxidant by Ce–Cr doped magnetite@ rGO,” *Materials Chemistry and Physics*, vol. 275, pp. 125298, 2022.
- [84] P.R. de Almeida, A.M. Murad, L.P. Silva, E.L. Rech, and E.S. Alves, “Development of a Graphene-Based Biosensor for

- Detecting Recombinant Cyanovirin-N,” *Biosensors*, vol. 10, pp. 206, 2020.
- [85] MD. Prakash, BG. Nelam, S. Ahmadsaidulu, A. Navaneetha, and AK. Panigrahy, “Performance analysis of ion-sensitive field effect transistor with various oxide materials for biomedical applications,” *Silicon*, vol.1, pp. 1-11, 2021.
- [86] N. Moser, TS. Lande, C. Toumazou, and P. Georgiou, “ISFETs in CMOS and emergent trends in instrumentation: A review,” *IEEE Sensors Journal*, vol. 16, pp. 6496-6514, 2016.
- [87] B. Nemeth, MS. Piechocinski, and DR. Cumming, “High-resolution real-time ion-camera system using a CMOS-based chemical sensor array for proton imaging,” *Sensors and Actuators B: Chemical*, vol. 171, pp. 747-752, 2012.
- [88] V. Pachauri and S. Ingebrandt, “Biologically sensitive field-effect transistors: from ISFETs to NanoFETs,” *Essays in biochemistry*, vol. 60, pp. 81-90, 2016.
- [89] J. Broomfield, M. Kalofonou, T. Pataillot-Meakin, SM. Powell, RC. Fernandes, N. Moser, et al. “Detection of YAP1 and AR-V7 mRNA for Prostate Cancer prognosis using an ISFET Lab-On-Chip platform,” *ACS sensors*, vol. 7, pp. 3389-3398, 2022.
- [90] MK. Bind and K. Nigam, “Sensitivity analysis of junction free electrostatically doped tunnel-FET based biosensor,” *Silicon*, vol. 1, pp. 1-13, 2022.
- [91] A. Nukazuka, S. Asai, K. Hayakawa, K. Nakagawa, M. Kanazashi, H. Kakizoe, et al. “Electrical biosensing system utilizing ion-producing enzymes conjugated with aptamers for the sensing of severe acute respiratory syndrome coronavirus 2,” *Sensing and Bio-Sensing Research*, vol. , pp. 100549, 2023.
- [92] V. Dhandapani and B. Raj, “Design and Performance Assessment of Graded Channel Gate-All-Around Silicon Nanowire FET for Biosensing Applications,” *Silicon*, vol. , pp. 1-8, 2023.
- [93] Y. Kim and W-J. Cho, “Self-sensitivity amplifiable dual-gate ion-sensitive field-effect transistor based on high-k engineered dielectric layer,” *Japanese Journal of Applied Physics*. 2023.
- [94] V. Prathap and AH. Titus, “ISFET Pixel Array with selectable sensitivity and bulk-based offset-drift nullification capability for reduction of non-ideality effects,” *IEEE Sensors Journal*. 2023.
- [95] A. la Grasta, M. De Carlo, A. Di Nisio, F. Dell’Olio and VM. Passaro, “Potentiometric Chloride Ion Biosensor for Cystic Fibrosis Diagnosis and Management: Modeling and Design,” *Sensors*, vol. 23, pp. 2491, 2023.
- [96] O. Synhaivska, Y. Mermoud, M. Baghernejad, I. Alshanski, M. Hurevich, S. Yitzchaik, et al. “Detection of Cu²⁺ ions with GGH peptide realized with Si-nanoribbon ISFET,” *Sensors*, vol. 19, pp. 4022, 2019.
- [97] I. Fakh, A. Centeno, A. Zurutuza, B. Ghaddab, M. Siaj, and T. Szkopek, “High resolution potassium sensing with large-area graphene field-effect transistors,” *Sensors and Actuators B: Chemical*, vol. 291, pp. 89-95, 2019.
- [98] A. la Grasta, M. De Carlo, F. Dell’Olio, and VM. Passaro, “Modelling and Design of an ISFET-Based NaCl Sensor for Cystic Fibrosis Diagnosis and Management,” *Proceedings of SIE 2022: 53rd Annual Meeting of the Italian Electronics Society: Springer*, vol. , pp. 117-121, 2023.
- [99] RA. Rani and O. Sidek, “ISFET pH sensor characterization: towards biosensor microchip application,” *IEEE Region 10 Conference TENCON*, Vol. 500, pp. 660-663, 2004.
- [100] AP. Soldatkin, VN. Arkhypova, SV. Dzyadevych, V. Anna, J-M. Gravouelle, N. Jaffrezic-Renault, et al. “Analysis of the potato glycoalkaloids by using of enzyme biosensor based on pH-ISFETs,” *Talanta*, vol.66, pp. 28-33, 2005.
- [101] D. Zhu, Y. Sun, and Z. Shi, “Research of CMOS biosensor IC for extracellular electrophysiological signal recording and pH value measuring,” *2008 9th International Conference on Solid-State and Integrated-Circuit Technology: IEEE*, vol. , pp. 2557-60, 2008.

- [102] T-E. Bae, H-J. Jang, S-W. Lee, and W-J. Cho, "Enhanced sensing properties by dual-gate ion-sensitive field-effect transistor using the solution-processed Al₂O₃ sensing membranes," *Japanese Journal of Applied Physics*, vol. 52, pp. 06GK3, 2013.
- [103] HJ. Chen and C-Y. Chen, "Ion-sensitive field-effect transistors with periodic-groove channels fabricated using nanoimprint lithography," *IEEE electron device letters*, vol.34, pp. 541-543, 2013.
- [104] JC. Dutta, HR. Thakur, and G. Keshwani, "High-Performance Dual-Gate Carbon Nanotube Ion-Sensitive Field Effect Transistor With High- κ Top Gate and Low- κ Bottom Gate Dielectrics," *IEEE Sensors Journal*, vol. 19, pp. 5692-5699, 2019.
- [105] Y. Wang, M. Yang, and C. Wu, "Design and implementation of a pH sensor for micro solution based on nanostructured ion-sensitive field-effect transistor," *Sensors*, vol. 20, pp. 6921, 2020.
- [106] A. Zain, AM. Dinar, F. Salehuddin, H. Hazura, A. Hanim, S. Idris, et al. "Beyond Nernst Sensitivity of Ion Sensitive Field Effect Transistor based on Ultra-Thin Body Box FDSOI," *Journal of Physics: Conference Series*, Vol. 1502, pp. 012048, 2020.
- [107] Jeon J-H, Cho W-J. "High-performance extended-gate ion-sensitive field-effect transistors with multi-gate structure for transparent, flexible, and wearable biosensors," *Science and Technology of Advanced Materials*. Vol. 21, pp. 371-378, 2020.
- [108] Cho S-K, Cho W-J. "Ultra-high sensitivity pH-sensors using silicon nanowire channel dual-gate field-effect transistors fabricated by electrospun polyvinylpyrrolidone nanofibers pattern template transfer," *Sensors and Actuators B: Chemical*. Vol. 326, pp.128835, 2021.
- [109] BS. Emmanuel, "Analysis of output characteristics of ion sensitive field effect transistor based biosensor for measurement of pH in biochemical solutions," *Global Journal of Engineering and Technology Advances*. Vol. 11, pp. 087-095, 2022.
- [110] Vu C-A, Chen W-Y. "Field-effect transistor biosensors for biomedical applications: recent advances and future prospects," *Sensors*. Vol. 19, pp. 4214, 2019.
- [111] B. Veigas, E. Fortunato, and PV. Baptista. "Field effect sensors for nucleic acid detection: recent advances and future perspectives," *Sensors*. Vol. 15, pp.10380-10398, 2015.
- [112] Lee C-S, Kim SK, and Kim M. "Ion-sensitive field-effect transistor for biological sensing," *Sensors*. Vol. 9, pp. 7111-7131, 2009.
- [113] M. Mahdavi, A. Samaeian, M. Hajmirzaheydarali, M. Shahmohammadi, S. Mohajerzadeh, and M. Malboobi, "Label-free detection of DNA hybridization using a porous poly-Si ion-sensitive field effect transistor," *RSC advances*. Vol. 4, pp. 36854-36863, 2014.
- [114] Xu G, Abbott J, and Ham D. "Optimization of CMOS-ISFET-based biomolecular sensing: analysis and demonstration in DNA detection," *IEEE Transactions on Electron Devices*. Vol. 63, pp. 3249-3256, 2016.
- [115] Ma S, Lee Y-K, Zhang A, and Li X. "Label-free detection of Cordyceps sinensis using dual-gate nanoribbon-based ion-sensitive field-effect transistor biosensor," *Sensors and Actuators B: Chemical*. Vol. 264, pp. 344-352, 2018.
- [116] Chang C-F, and Lu MS-C, "CMOS ion sensitive field effect transistors for highly sensitive detection of DNA hybridization," *IEEE Sensors Journal*. Vol. 20, pp. 8930-8937, 2020.
- [117] Xu Y, Tavakkoli H, Xu J, and Lee Y-K. A. "Low-drift Extended-Gate Field Effect Transistor (EGFET) with Differential Amplifier for Cordyceps Sinensis DNA Detection Optimized by g m/I D Theory," 2020 IEEE 15th International Conference on Nano/Micro Engineered and Molecular System (NEMS): IEEE, pp. 398-401, 2020.
- [118] Lee C, Chen Y-W, and Lu MS-C. "CMOS biosensors for the detection of DNA hybridization in high ionic-strength solutions," *IEEE Sensors Journal*. Vol. 21, pp. 4135-4142, 2020.

- [119] A. Ganguli, V. Faramarzi, A. Mostafa, MT. Hwang, S. You, and R. Bashir. "High sensitivity graphene field effect transistor-based detection of DNA amplification," *Advanced Functional Materials*. Vol. 30, pp. 2001031, 2020.
- [120] P. Sun, Y. Cong, M. Xu, H. Si, D. Zhao, and D. Wu, "An ISFET microarray sensor system for detecting the DNA base pairing," *Micromachines*. Vol. 12, pp. 731, 2021.
- [121] X. You and JJ. Pak, "Graphene-based field effect transistor enzymatic glucose biosensor using silk protein for enzyme immobilization and device substrate," *Sensors and Actuators B: Chemical*. Vol. 202, pp. 1357-1365, 2014.
- [122] L. Sarcina, E. Macchia, A. Tricase, C. Scandurra, A. Imbriano, F. Torricelli, et al. "Enzyme based field effect transistor: State-of-the-art and future perspectives," *Electrochemical Science Advances*. pp. e2100216, 2022 .
- [123] Bhatt VD, Joshi S, Becherer M, and Lugli P. "Flexible, low-cost sensor based on electrolyte gated carbon nanotube field effect transistor for organo-phosphate detection," *Sensors*. Vol. 17, pp. 1147, 2017.
- [124] Wang R, Wang Y, Qu H, and Zheng L. "An Acetylcholinesterase-Functionalized Biosensor for Sensitive Detection of Organophosphorus Pesticides Based on Solution-Gated Graphene Transistors," *ACS Agricultural Science & Technology*. Vol. 1, pp. 372-378, 2021.
- [125] Arkhypova V, Soldatkin O, Mozhylevska L, Konvalyuk I, Kunakh V, and Dzyadevych S. "Enzyme biosensor based on pH-sensitive field-effect transistors for assessment of total indole alkaloids content in tissue culture of *Rauwolfia serpentina*," *Electrochemical Science Advances*. Vol. 2, pp. e2100152, 2022.
- [126] Fenoy GE, Marmisollé WA, Azzaroni O, and Knoll W. "Acetylcholine biosensor based on the electrochemical functionalization of graphene field-effect transistors," *Biosensors and Bioelectronics*. Vol. 148, pp. 111796, 2020.
- [127] Chae M-S, Yoo YK, Kim J, Kim TG, and Hwang KS. "Graphene-based enzyme-modified field-effect transistor biosensor for monitoring drug effects in Alzheimer's disease treatment," *Sensors and Actuators B: Chemical*. Vol. 272, pp. 448-458, 2018.
- [128] Korpan YI, Raushel FM, Nazarenko EA, Soldatkin AP, Jaffrezic-Renault N, and Martelet C. "Sensitivity and specificity improvement of an ion sensitive field effect transistors-based biosensor for potato glycoalkaloids detection," *Journal of agricultural and food chemistry*. Vol. 54, pp. 707-712, 2006.
- [129] Kwak YH, Choi DS, Kim YN, Kim H, Yoon DH, Ahn S-S, et al. "Flexible glucose sensor using CVD-grown graphene-based field effect transistor," *Biosensors and Bioelectronics*. Vol. 37, pp. 82-87, 2012.
- [130] Wang B, Luo Y, Gao L, Liu B, and Duan G. "High-performance field-effect transistor glucose biosensors based on bimetallic Ni/Cu metal-organic frameworks," *Biosensors and Bioelectronics*. Vol. 171, pp. 112736, 2021.
- [131] Farahmandpour M, Haghshenas H, and Kordrostami Z. "Blood glucose sensing by back gated transistor strips sensitized by CuO hollow spheres and rGO," *Scientific Reports*, Vol. 12, pp. 21872, 2022.
- [132] Archana R, Sreeja B, Nagarajan K, Radha S, BalajiBhargav P, Balaji C, et al. "Development of highly sensitive Ag NPs decorated graphene FET sensor for detection of glucose concentration," *Journal of Inorganic and Organometallic Polymers and Materials*. Vol. 30, pp. 3818-3825, 2020.
- [133] M. Farahmandpour, Z. Kordrostami, M. Rajabzadeh, and R. Khalifeh, "Flexible Bio-Electronic Hybrid Metal-Oxide Channel FET as a Glucose Sensor," *IEEE Transactions on NanoBioscience*. 2023.

- [134] K. Koike, T. Sasaki, K. Hiraki, K. Ike, Y. Hirofujii, and M. Yano. "Characteristics of an extended gate field-effect transistor for glucose sensing using an enzyme-containing silk fibroin membrane as the bio-chemical component," *Biosensors*. Vol. 10, pp. 57, 2020.
- [135] JW. Park, C. Lee, and J. Jang, "High-performance field-effect transistor-type glucose biosensor based on nanohybrids of carboxylated polypyrrole nanotube wrapped graphene sheet transducer," *Sensors and Actuators B: Chemical*. Vol. 208, pp. 532-537, 2015.
- [136] Das M, Chakraborty T, Lin CY, Lin R-M, and Kao CH. "Screen-printed Ga₂O₃ thin film derived from liquid metal employed in highly sensitive pH and non-enzymatic glucose recognition," *Materials Chemistry and Physics*. Vol. 278, pp.125652, 2022.
- [137] Forzani ES, Zhang H, Nagahara LA, Amlani I, Tsui R, and Tao N. "A conducting polymer nanojunction sensor for glucose detection," *Nano Letters*. Vol. 4, pp. 1785-1788, 2004.
- [138] H. Yoon, S. Ko, and J. Jang, "Field-effect-transistor sensor based on enzyme-functionalized polypyrrole nanotubes for glucose detection," *The Journal of Physical Chemistry B*. vol. 112, pp. 9992-9997, 2008.
- [139] Huang Y, Dong X, Shi Y, Li CM, Li L-J, and Chen P. "Nanoelectronic biosensors based on CVD grown graphene," *Nanoscale*. Vol. 2, pp. 1485-1488, 2010.
- [140] Wu Y-L, Hsu P-Y, and Lin J-J. "Polysilicon wire glucose sensor highly immune to interference," *Biosensors and Bioelectronics*. Vol. 26, pp. 2281-2286, 2011.
- [141] Luo X-L, Xu J-J, Zhao W, Chen H-Y. Glucose biosensor based on ENFET doped with SiO₂ nanoparticles. *Sensors and Actuators B: Chemical*. Vol. 97, pp. 249-255, 2004.
- [142] Tomari N, Sasamoto K, Sakai H, Tani T, Yamamoto Y, and Nishiya Y. "New enzymatic assays based on the combination of signal accumulation type of ion sensitive field effect transistor (SA-ISFET) with horseradish peroxidase," *Analytical biochemistry*. Vol. 584, pp. 113353, 2019.
- [143] MS. Andrianova, VP. Grudtsov, NV. Komarova, EV. Kuznetsov, and AE. Kuznetsov, "ISFET-based aptasensor for thrombin detection using horseradish peroxidase," *Procedia engineering*. Vol. 174, pp. 1084-1092, 2017.
- [144] AA. Shul'ga and TD. Gibson, "An alternative microbiosensor for hydrogen peroxide based on an enzyme field effect transistor with a fast response," *Analytica chimica acta*. Vol. 296, pp. 163-170, 1994.
- [145] V. Volotovskiy and N. Kim, "Multienzyme inhibition biosensor for amygdalin measurement," *Electroanalysis: An International Journal Devoted to Fundamental and Practical Aspects of Electroanalysis*. Vol. 10, pp. 512-514, 1998.
- [146] V. Volotovskiy and N. Kim. "Cyanide determination by an ISFET-based peroxidase biosensor," *Biosensors and Bioelectronics*. Vol. 13, pp. 1029-1033, 1998.
- [147] V. Volotovskiy and N. Kim, "Determination of glucose, ascorbic and citric acids by two-ISFET multienzyme sensor," *Sensors and Actuators B: Chemical*. Vol. 49, pp. 253-257, 1998.
- [148] Starodub N, Dzantiev B, Starodub V, and Zherdev A. "Immunosensor for the determination of the herbicide simazine based on an ion-selective field-effect transistor," *Analytica Chimica Acta*. Vol. 424, pp. 37-43, 2000.
- [149] Z. Wang, H. Yu, and Z. Zhao, "Silk fibroin hydrogel encapsulated graphene field-effect transistors as enzyme-based biosensors," *Microchemical Journal*. Vol. 169, pp. 106585, 2021.
- [150] MA. Barik, MK. Sarma, C. Sarkar, and JC. Dutta, "Highly sensitive potassium-doped polypyrrole/carbon nanotube-based enzyme field effect transistor (ENFET) for cholesterol detection," *Applied biochemistry and biotechnology*. Vol. 174, pp. 1104-1114, 2014.
- [151] H. Suzuki and Y. Matsugi, "Integrated microfluidic system for the simultaneous determination of ammonia, creatinine, and

- urea,” *Sensors and Actuators B: Chemical*. Vol. 108, pp. 700-707, 2005.
- [152] M. Jurkiewicz, S. Alegret, J. Almirall, M. Garcia, E. Fabregas, “Development of a biparametric bioanalyser for creatinine and urea,” *Validation of the determination of biochemical parameters associated with hemodialysis. Analyst*. Vol. 123, pp. 1321-1327, 1998.
- [153] Wesoły M, Cetó X, Del Valle M, Ciosek P, and Wróblewski W. “Quantitative analysis of active pharmaceutical ingredients (APIs) using a potentiometric electronic tongue in a SIA flow system,” *Electroanalysis*. Vol. 28, pp. 626-632, 2016.
- [154] Ebrahimi S, Nataj ZE, Khodaverdian S, Khamsavi A, Abdi Y, and Khajeh K. “An ion-sensitive field-effect transistor biosensor based on SWCNT and aligned MWCNTs for detection of ABTS,” *IEEE Sensors Journal*. Vol. 20, pp. 14590-14597, 2020.
- [155] Bi Y, Ye L, Mao Y, Wang L, Qu H, Liu J, et al. “Porous carbon supported nanoceria derived from one step in situ pyrolysis of Jerusalem artichoke stalk for functionalization of solution-gated graphene transistors for real-time detection of lactic acid from cancer cell metabolism,” *Biosensors and Bioelectronics*. Vol. 140, pp. 111271, 2019.
- [156] Kotsakis SD, Miliotis G, Tzelepi E, Tzouvelekis LS, and Miriagou V. “Detection of carbapenemase producing enterobacteria using an ion sensitive field effect transistor sensor,” *Scientific Reports*. Vol. 11, pp. 1-14, 2021.
- [157] G. Keshwani, JC. Dutta, “CNT based high- κ dielectric Ion Sensitive Field Effect Transistor Based Cholesterol Biosensor,” *Current Trends in Biotechnology and Pharmacy*. Vol. 15, pp. 182-188, 2021.
- [158] P-Y. Kuo, Y-Y. Chen, W-H. Lai, and C-H. Chang, “An extended-gate field-effect transistor applied to resistive divider integrated with the readout circuit using 180nm CMOS process for uric acid detection,” *IEEE Sensors Journal*. Vol. 21, pp. 20229-20238, 2021.
- [159] Liu N, Xiang X, Fu L, Cao Q, Huang R, Liu H, et al. “Regenerative field effect transistor biosensor for in vivo monitoring of dopamine in fish brains,” *Biosensors and Bioelectronics*. Vol. 188, pp. 113340, 2021.
- [160] T-M. Pan and C-H. Lin, “High Performance NiOx Extended-Gate Field-Effect Transistor Biosensor for Detection of Uric Acid,” *Journal of The Electrochemical Society*. Vol. 168, pp. 017511, 2021.
- [161] Jang H-J, Ahn J, Kim M-G, Shin Y-B, Jeun M, Cho W-J, et al. “Electrical signaling of enzyme-linked immunosorbent assays with an ion-sensitive field-effect transistor,” *Biosensors and Bioelectronics*. Vol. 64, pp. 318-323, 2015.
- [162] O. Kutova, M. Dusheiko, NI. Klyui, and VA. Skryshevsky, “C-reactive protein detection based on ISFET structure with gate dielectric SiO₂-CeO₂,” *Microelectronic Engineering*. Vol. 215, pp. 110993, 2019.
- [163] AE. Kuznetsov, NV. Komarova, EV. Kuznetsov, MS. Andrianova, VP. Grudtsov, EN. Rybachek, et al. “Integration of a field effect transistor-based aptasensor under a hydrophobic membrane for bioelectronic nose applications,” *Biosensors and Bioelectronics*. Vol. 129, pp. 29-35, 2019.
- [164] R. Campos, J. Borme, and JR. Guerreiro, Jr G. Machado, Mft. Cerqueira, DY. Petrovykh, et al. “Attomolar label-free detection of DNA hybridization with electrolyte-gated graphene field-effect transistors,” *ACS sensors*. Vol. 4, pp. 286-293, 2019.

THIS PAGE IS INTENTIONALLY LEFT BLANK.