

Numerical Simulation of Ultrasonic Assisted Indentation Tube Forming

Saeid Dashti¹, Masih Paknejad², *, Amir Abdullah³

Department of Mechanical Engineering,

Amirkabir University of Technology, Tehran, Iran

E-mail: saeiddashti@aut.ac.ir, m.paknejad@aut.ac.ir, amirah@aut.ac.ir

*Corresponding author

Abbas Pak⁴

Department of Mechanical Engineering,

Bu-Ali Sina University, Hamedan, Iran

E-mail: a.pak@basu.ac.ir

Received: 30 May 2019, Revised: 26 September 2019, Accepted: 4 October 2019

Abstract: Indentation forming is an internal tube forming process in which a mandrel with a diameter slightly larger than that of the tube is pressed inside the tube and in so doing, creates the internal profile. Forming forces have a significant effect on the spring back, residual stress, quality of the inner surface, quality of tube dimensions, and tool wear. In this study, the forming process of CK45 steel tube by carbide tungsten tool in the presence of ultrasonic vibration has been simulated and the effect of ultrasonic on the forming mechanism has been investigated by introducing two regimes according to the forming conditions. The effects of tool feed-speed and amplitude of vibration on forming force reduction have been investigated. According to the simulation results, the main reason for the force reduction in the presence of longitudinal tube ultrasonic vibration is the intermittent phenomenon which is the continuous or impulsive regime. The critical amplitude which determines the borderline of continuous and impulsive regimes is obtained 38 μ m by the simulation of the process. The maximum force reduction obtained in continuous regime is 64.2% at the critical amplitude. The simulation results are consistent well with the previous experimental data.

Keywords: Finite Element Method, Indentation Tube Forming, Intermittent Phenomenon, Ultrasonic Vibration

Reference: Saeid Dashti, Masih Paknejad, Amir Abdullah, and Abbas Pak, "Numerical Simulation of Ultrasonic Assisted Indentation Forming of Tube", *Int J of Advanced Design and Manufacturing Technology*, Vol. 13/No. 3, 2020, pp. 1–8. DOI: 10.30495/admt.2020.1869462.1124.

Biographical notes: **Saeid Dashti** received his MSc from Amirkabir University, Tehran, Iran. His research interest includes ultrasonic engineering, and finite element method. **Masih Paknejad** received his PhD from Amirkabir University of Technology, Tehran, Iran. His research interest includes ultrasonic engineering, metrology, grinding, and forming process. **Amir Abdullah** is an Associate Professor in Mechanical Engineering at Amirkabir University of Technology. His research interest includes ultrasonic, acoustic simulation, transducers, and wave propagation. **Abbas Pak** is an Assistant Professor in Mechanical Engineering at Bu-Ali Sina University. His research interest includes advanced manufacturing processes, and manufacturing processes.

1 INTRODUCTION

Indentation forming process is used for sizing and creating the internal surface of thick-walled tubes. In this process, a tool with a diameter slightly larger than the internal diameter of the tube is pressed into the tube and calibrates internal profile of the tube with small plastic deformation. The tool stick-slip problems were frequently encountered in this process which can cause tool breaking; applying ultrasonic vibration can reduce the stick-slip severity by changing the mechanism of formation. In ultrasonic assisted indentation forming, vibrations with low amplitude and high frequency in the longitudinal direction are applied on the tube. Forming forces reduction in the presence of ultrasonic vibration occurs due to intermittent phenomena which can decrease the effective time of interaction and friction force between tool and tube. Also, better surface roughness, uniform distribution of dislocations, lower stress concentration and longer tool life are achievable by ultrasonic assisted indentation forming. Applying ultrasonic vibrations to the tube forming process is a high speed phenomenon occurring at a short period of time which makes it difficult to measure the details of the mechanism. Simulation of this process can help to understand the mechanism of ultrasonic assisted tube forming better.

The first application of ultrasonic vibrations in metal forming was reported by Garskii and Efromov [1]. Later, Blaha and Langenecker [2] applied ultrasonic vibrations to zinc single crystal during the tensile test. Their results showed a great reduction of yield strength in the sample by around 40% owing to ultrasonic softening effect. Siddiq and El Sayed [3] studied numerical simulation of sheet metal forming, wire drawing and upsetting process in the presence of ultrasonic vibrations. In their investigation, porous plastics model was used to simulate the material softening owing to applying ultrasonic vibration energy. Murakawa and Jin [4] and Murakawa, et al. [5] experimentally investigated ultrasonic assisted wire drawing process by radially and axially dies vibration. High-viscosity lubricants can be replaced by low-viscosity lubricants as an advantage of ultrasonic application in wire drawing process to reduce environmental pollution. Huang, et al. [6] showed that using ultrasonic vibrations can decrease friction forces and also improve lubrication in the upsetting process. Hayashi, et al. [7] simulated the ultrasonic assisted wire drawing process by radially and longitudinally vibrated dies using ABAQUS software. Mousavi, et al. [8] investigated the numerical simulation of direct extrusion of sheet metal using ultrasonic vibrations. Also, they studied the effects of ultrasonic parameters including amplitude and frequency on the forming force reduction.

Hayashi, et al. [7] and Mousavi, et al. [8] investigated the relation between wire drawing speed and effectiveness of ultrasonic vibration; they observed that the effect of ultrasonic vibration on force reduction is dissipated when the speed is equal to the critical value ($v=c_0$). Hung and Chiang [9] investigated the ultrasonic assisted extrusion of aluminium alloy in which temperature increase due to applying the ultrasonic was reported as the main reason for force reduction. Pazand and Feizi [10] introduced an artificial neural network model to investigate ultrasonic vibration effects on the extrusion process. Abdullah, et al. [11] presented a theoretical analysis of ultrasonic assisted indentation tube forming which was verified by experimental tests. Their model describes how ultrasonic vibrations would be effective in the force reduction by introducing the impulsive and continuous forming regimes. They also investigated the effects of vibration amplitude and tool feed- speed on the forming force reduction. Findings of the researchers about ultrasonic assisted forming processes ascribe force reduction to lots of reasons including acoustic softening, local thermal softening, dynamic recrystallization, frictional force reduction, and intermittent phenomena. Moreover, the difficulty of online measurements of intermittent phenomena during the experimental application of ultrasonic vibration can be solved by numerical simulation of the process for a better understanding of the ultrasonic effect on the forming mechanism.

Accordingly, in order to find the dominant effect of ultrasonic vibration on the force reduction, a 3D numerical modelling of indentation forming process with and without longitudinal ultrasonic vibration of the tube has been investigated. This study not only simulates the impulsive and continuous forming regimes as dominant mechanisms of ultrasonic effects by introducing the critical amplitude but also numerically analyses the effects of parameters including tool feed-speed and vibration amplitude on forming force reduction and the related critical conditions. Moreover, the results of FEM simulation were evaluated by the results of previous experimental tests and demonstrated lower errors in comparison with the theoretical predictions.

2 NUMERICAL SIMULATION

The simulation of indentation forming process includes the tungsten carbide tool and the CK45 steel tube in the presence of ultrasonic vibration. It should be noted that the experimental analysis of this process has been done in previous work [11] which its schematic and experimental setup has been shown in “Fig. 1”.



a)

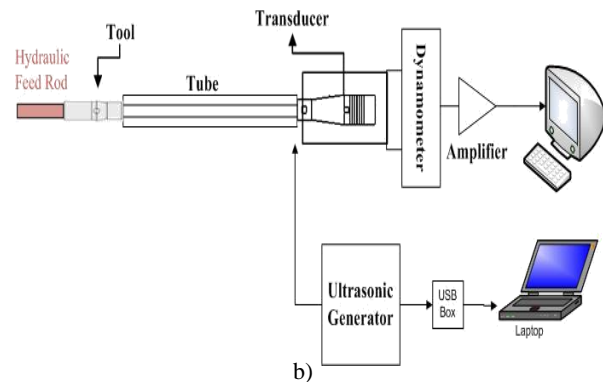

b)

Fig. 1 (a): Setup view, and (b): Schematic of experimental setup [11].

2.1. Modal Analysis

For the purpose of having the best influences of ultrasonic vibration, the tube should be longitudinally vibrated at its resonance frequency. The modal analysis of the tube should be done to find the appropriate mode shape and resonance frequency of the tube. Also, the 3 kW piezoelectric ultrasonic transducer which was attributed to the experimental test must be designed at the same resonance frequency as the tube. The modal analysis of the transducer with the resonance frequency of 24496 Hz is shown in “Fig. 2”.

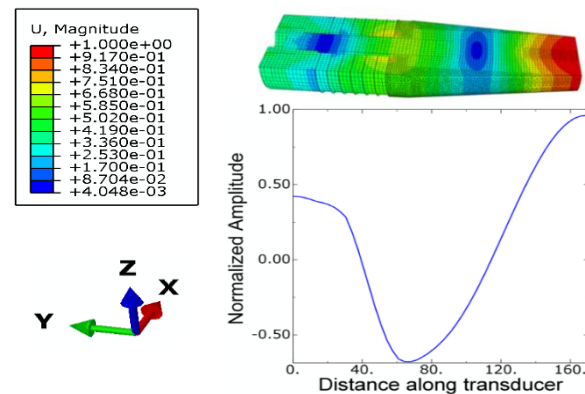

Fig. 2 Modal analysis and mode shape of transducer at longitudinal resonance frequency of 24496 Hz obtained by ABAQUS software.

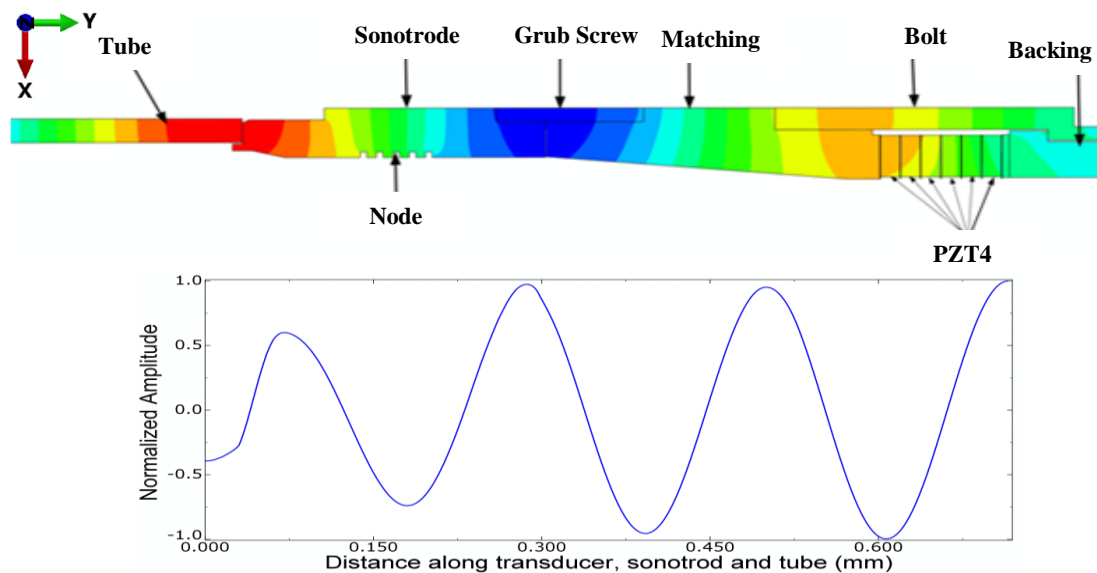

Fig. 3 Modal analysis and mode shape of tube, transducer, and sonotrode at longitudinal resonance frequency of 24496 Hz obtained by ABAQUS software.

This frequency is used as the ultrasonic vibration frequency in the simulation of ultrasonic assisted indentation forming process which has a negligible difference with the experimental frequency (24748 Hz). Moreover, the modal analysis of the setup including tube, transducer, and sonotrode has been done to verify that all elements of the setup longitudinally vibrate at the designed frequency (“Fig. 3”).

2.2. Boundary Conditions

The simulation of indentation forming process has been done as a 3D model to assume the effects of the helical groove of the tool. To reduce the finite element simulation cost, the tool initially enters the tube without ultrasonic vibrations and then the vibrations are applied to the tube in a short period of forming time. In this work, the tungsten carbide tool is considered as a rigid material while the tube is supposed to be CK45. According to the tensile test of CK45 which is performed based on ASME A370, the material specifications of the tube which are input parameters to the software are shown in “Table 1”. Also, the tensile test diagram of CK45 has been shown in “Fig. 4”.

Table 1 Tube material properties

Symbol	Description	Value	Unit
σ	Yield Strength	540	MPa
E	Elastic Modulus	203	GPa
K	Strength Coefficient	1228.55	MPa
n	Strain Hardening Exponent	0.139	--

Also, the length and cone angle of the tool are assumed to be 37 mm and 7 degrees, respectively. In this process, the tool has three important parts including guiding, forging and sizing that their related lengths are 10 mm, 1.4 mm, and 0.85 mm, respectively. The diameter of the sizing tool part is 8.06 mm (“Fig. 5”). The tube length, internal and external diameters are 415 mm, 7.72 mm, and 25 mm, respectively.

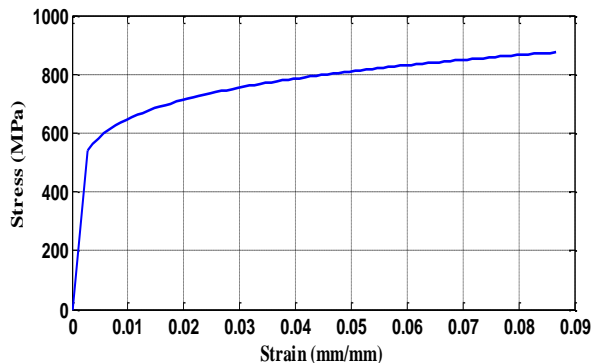

Fig. 4 Experimental stress–strain curve for DIN CK45 (EN1.1191) material used in the experimental tests.

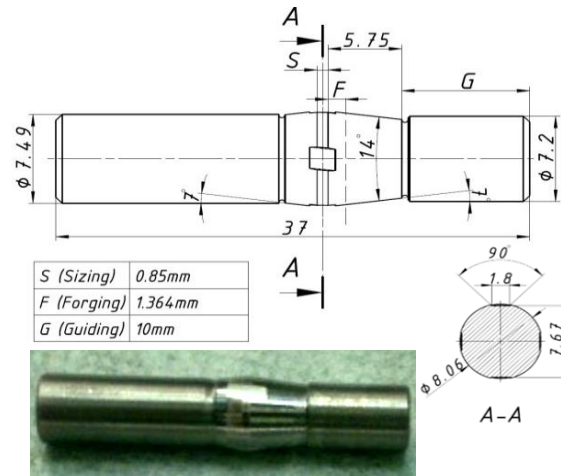

Fig. 5 View and drawing of the forming tool.

Representative indentation tube forming geometries generally require three-dimensional modelling and include nonlinear material behaviour and discontinuous effects. Since the problem size is large and the discontinuous effects dominate the solution, the explicit dynamics approach is often less expensive computationally and more reliable than an implicit quasi-static solution technique [12]. This analysis was conducted entirely within ABAQUS/Explicit using the rigid (R3D4) and deformable (C3D8R) elements for the tool and tube, respectively as shown in “Fig. 6”. In this analysis, the automatic time incrementation scheme is used to ensure numerical stability and to advance the solution in time. Moreover, mass scaling is used to reduce the computational cost of the analysis in the period of forming without applying ultrasonic vibration. Also, adaptive mesh (ALE) is applied to smooth the entire model.

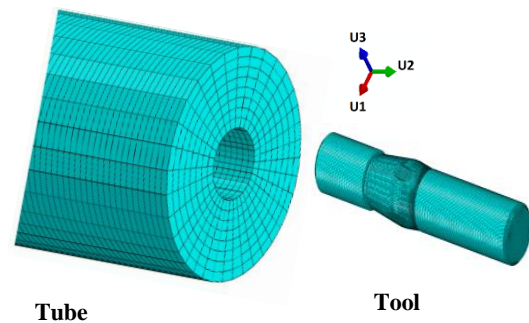

Fig. 6 Tube and tool mesh.

Also, the kinematic contact formulation is used to model the friction between the tool and tube. According to the results of similar processes such as extrusion with lubricant, the friction coefficient has been reported

between 0.02 to 0.05 [13], also, experimental study of tube drawing process using zinc sulphate and soap solution resulted in the friction coefficient between 0.032 to 0.049 [14]. In the present experimental indentation forming tests, copper sulphate and oil are used as lubricants, and the friction coefficient is considered to be 0.03 in the simulation analysis.

The boundary conditions at the beginning of the tube are defined as a free condition. The axial ultrasonic vibration is applied to the end of the tube; it means that in U2 direction, the boundary condition is considered to be $asin(\omega t) = asin(2\pi ft)$. It should be noted that ultrasonic vibration has surface and volume effects; the surface effects include friction force reduction, built-up edge reduction, and intermittent phenomena while the volume effects include local temperature rising and material softening. In the present study, the effect of ultrasonic has been simulated just by applying amplitude of vibration to the tube; it means that only the intermittent effect is considered in the simulation.

Rotations about U1 and U3 (UR1 and UR3) are fixed at the end of the tube. Also, axial movement of the tool (U2), i.e. the feed speed of the forming process is defined to be similar to the experimental tool feed-speed which is much less than the maximum vibration speed ($a\omega$). Other boundary conditions of the tool are considered as fixed. In these conditions, the tube is allowed to rotate according to the helical groove of the tool. A brief of boundary conditions is shown in “Table 2”.

Table 2 Tube and tool boundary conditions

Component	Boundary Conditions
Workpiece (start of tube)	$U1 \neq 0, U2 \neq 0, U3 \neq 0, UR1 \neq 0, UR2 \neq 0, UR3 \neq 0$
Workpiece (end of tube)	$U2 = asin(2\pi ft), U1 \neq 0, U3 \neq 0, UR2 \neq 0, UR1 = UR3 = 0$
Tool	$U2 \neq 0, U1 = U3 = UR1 = UR2 = UR3 = 0$

3 RESULTS AND DISCUSSION

3.1. Effect of Ultrasonic Vibration on Axial Forming Force

The effect of ultrasonic vibration on the reduction of the axial forming force has been simulated just for a short length of the tube (about 1.9 mm) when the tool has been completely pressed into the tube at the length of 24 mm, it means that there is no vibration in the first 24 mm of the tube. The average and detailed view of fluctuation for axial force in the presence of ultrasonic vibration has been shown in “Fig. 7”. Applying ultrasonic vibration to the tube reduces the average axial force by 28.6% at the condition of the 1 μm amplitude of vibration, 24496 Hz frequency of vibration and 14 mm/s tool feed speed, which is a result of intermittent effect. This effect is a periodic separation of the tool from the tube during

applying ultrasonic vibration which can change the kinematics of the forming process and also reduce the contact force between tool and tube, and finally results in forming force reduction.

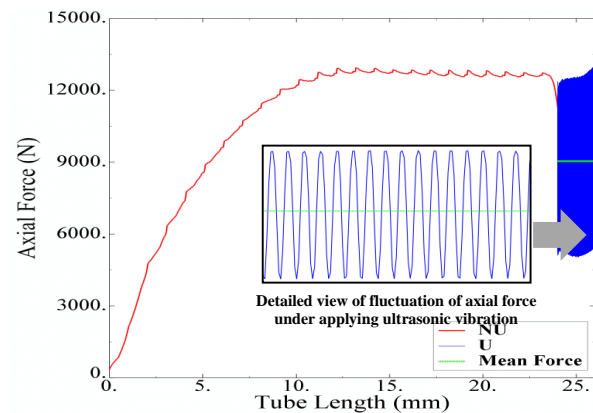

Fig. 7 Numerical simulation results of axial forming force with and without ultrasonic vibration and details of fluctuation in the presence of ultrasonic vibration at tool feed speed of 14 mm/s and amplitude vibration of 1 μm.

A comparison of mean axial force between experimental and the numerical simulation has been shown in “Fig. 8”. The difference between the simulation and experimental results is 9.78% for the conventional forming process which can be attributed to the local thermal softening of the tube due to the temperature rise at the contact zone between the tool and tube. Also, out of coaxiality of the tool and tube in the experiments and friction coefficient difference between the experimental and simulation conditions can be other sources of the reported error. Meanwhile, the relative error is insignificant in the presence of ultrasonic which gives an approval to the amplitude vibration assumption for this simulation.

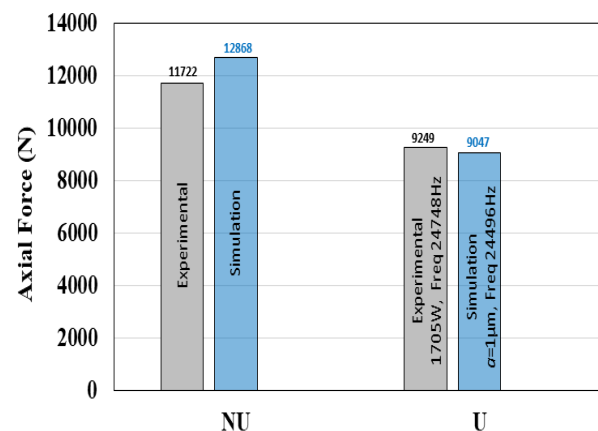

Fig. 8 Experimental and numerical simulation results of mean axial forming force with and without ultrasonic vibration.

3.2. Effect of tool feed-speed on axial forming force

As can be seen in “Fig. 9”, in the presence of ultrasonic vibration, the axial force reduction is 34% at tool feed-speed of 14 mm/s, while the effect of ultrasonic vibration on forming force reduction will be eliminated at tool feed-speed of 769.69 mm/s ($a\omega$) which is called critical speed; it means that when the tool feed-speed equals to

the maximum vibration speed ($a\omega$), the separation mechanism of the tool and tube due to ultrasonic vibration will be eliminated. Furthermore, this effect has been observed in some other ultrasonic assisted forming processes such as wire drawing [7], tube drawing [15], extrusion [8], and even in ultrasonic assisted machining process such as grinding [16].

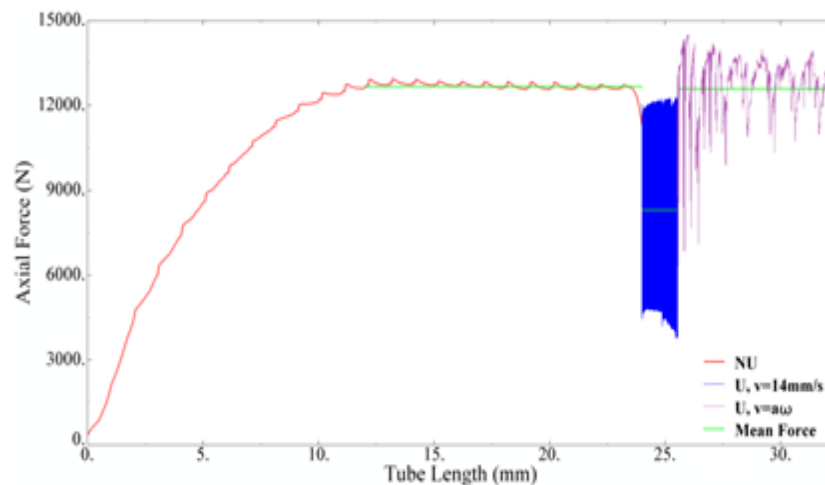

Fig. 9 Axial force for three conditions: 1) without ultrasonic vibration (NU) in the first 24 mm of the tube, 2): with ultrasonic vibrations (U) in the second part of the tube after 24 mm and feed speed of 14 mm/s during 0.11 second, 3): with ultrasonic vibrations and feed speed of 769.69 mm/s ($a\omega$) during 0.01 second.

Moreover, the effect of various tool feed-speeds on the axial force has been shown in “Fig. 10” which demonstrates a descending trend of the force reduction with the feed-speed, while the force reduction is equal to zero at the critical tool feed speed.

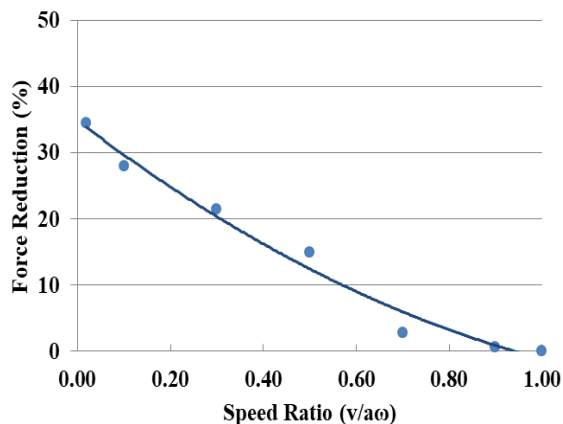

Fig. 10 Relation between the forming force reduction and tool feed-speed.

3.3. Effect of Ultrasonic Vibration Amplitude on Axial Forming Force

By considering $v < a\omega$ in our study based on real condition, the mechanism of ultrasonic assisted forming is described by two regimes including impulsive and

continuous ones; when the contact between tool and tube is always preserved, the regime will be continuous and it will switch to impulsive regime if the peak to peak amplitude of vibration ($2a$) is higher than the workpiece elastic limit [11]. The minimum amplitude satisfying the impulsive regime condition is called critical amplitude which is the border value between two above mentioned regimes. This impulsive regime is distinguishable by observing zero value of axial force fluctuation which is a result of separation between tool and tube. Therefore, as a result of numerical simulation, the critical amplitude is $38 \mu\text{m}$ as shown in “Fig. 11”.

Effect of ultrasonic vibration amplitude on axial forming force has been studied for the two regimes explained above; for continuous regime, the reduction of forces related to the amplitudes of $1 \mu\text{m}$, $5 \mu\text{m}$, and $10 \mu\text{m}$ are 28.6%, 34.5%, and 36.3% respectively (“Fig. 11 (a)”). While for impulsive regime, the forming force reductions corresponding to amplitudes of $38 \mu\text{m}$, $50 \mu\text{m}$, and $60 \mu\text{m}$ are 64.2%, 83%, and 90.2% respectively as shown in “Fig. 11 (b)”.

The results show that increasing amplitude causes more reduction of forming force in the presence of ultrasonic vibration in both continuous and impulsive regimes. The influence of increasing amplitude on the rate of force reduction in impulsive regime is more effective in comparison with continuous regime; the rate of force reduction is 0.86 for increasing amplitude from $1 \mu\text{m}$ to

10 μm , while this value is 1.57 for amplitude from 38 μm to 50 μm . The reduction of force is due to the hammering effect in continuous regimes, while in impulsive regime the periodic separation will be another reason of the force reduction. However, the intermittent effect will be reduced at higher amplitude which is due to the limitation of periodic separation of tool and tube.

The experimental force reduction in the presence of ultrasonic vibration is within the numerical simulation results which are obtained in continuous deformation regime (“Fig. 8”). Therefore, it can be concluded that the dominant phenomenon in the experimental tests in the presence of ultrasonic vibration is continuous deformation regime.

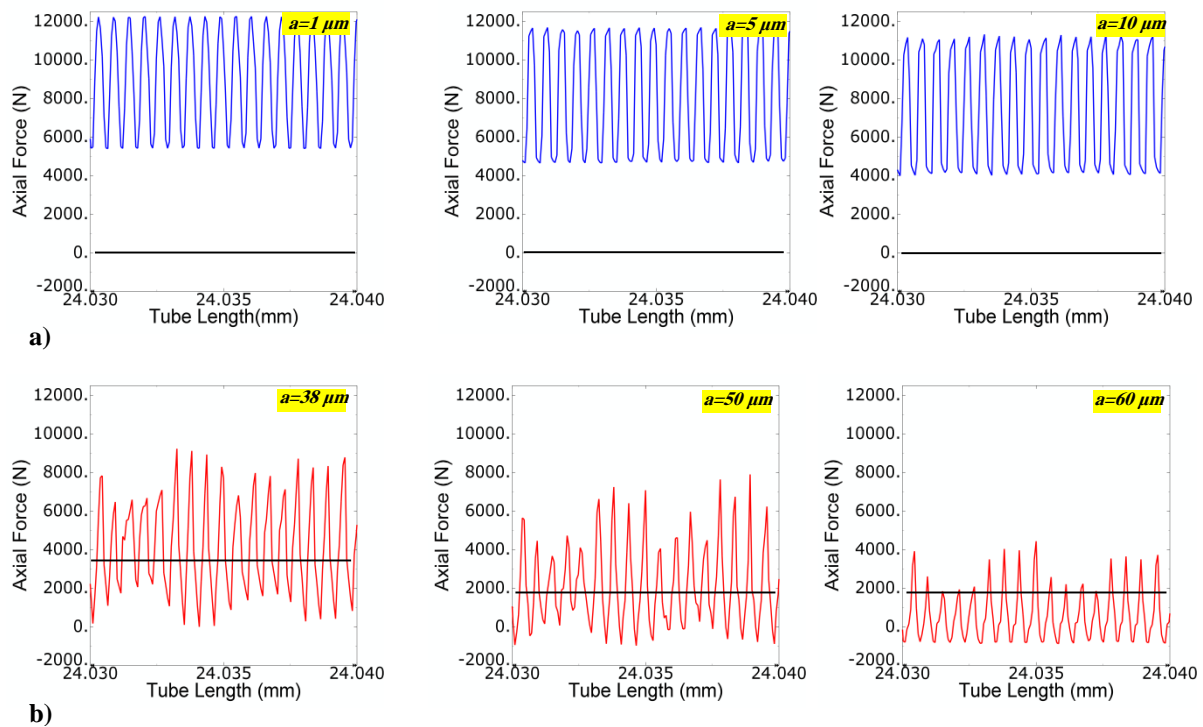

Fig. 11 Fluctuation of axial force as a result of numerical simulation in the presence of ultrasonic vibrations and tool feed-speed of 14 mm/s at various amplitudes of vibration including 1 μm , 5 μm , 10 μm , 38 μm , 50 μm , and 60 μm .

4 CONCLUSIONS

In this article, 3D numerical simulation of ultrasonic assisted indentation forming process has been studied and the effect of parameters including tool feed-speed and amplitude of vibration on forming force has been investigated. The simulation has been performed on CK45 as a workpiece tube and tungsten carbide as a tool which is considered as a rigid body. The comparison between simulation and experimental results has been done. The following results are obtained by the numerical simulation using ABAQUS software:

1. By increasing tool feed-speed, the effect of ultrasonic on the force reduction is decreased, while this effect is eliminated at the critical speed.
2. By increasing the amplitude of vibration, the hammering effect increases which causes force reduction, and at amplitudes higher than the critical value (38 μm), the continuous forming regime switches

to impulsive regime and the periodic separation effect appears.

3. The maximum force reduction in continuous regime is 64.2% at the critical amplitude.
4. The numerical simulation has a good agreement with the reported experimental results (relative error without ultrasonic: 9.78%, with ultrasonic: 2.18%).
5. The main reason of axial force reduction in presence of ultrasonic vibration is related to the intermittent phenomena.
6. Comparing the numerical simulation results of forming force reduction under ultrasonic vibration with the experimental results demonstrates that ultrasonic vibration behaviour is similar to the continuous regime.

REFERENCES

- [1] Garskii, F. K., Efromov, V. I., Effect of Ultrasound on the Decomposition of Solid Solutions, *Izv. Akad. Nauk, Beloroussk SSR*, Vol. 3, 1953.

- [2] Blaha, F., Langenecker, B., Dehnung Von Zink-Kristallen Unter Ultraschalleinwirkung, *Naturwissenschaften*, Vol. 42, 1955, pp. 556.
- [3] Siddiq, A., El Sayed, T., Ultrasonic-Assisted Manufacturing Processes: Variational Model and Numerical Simulations, *Ultrasonics*, Vol. 52, No. 4, 2012, pp. 521-9. DOI: 10.1016/j.ultras.2011.11.004.
- [4] Murakawa, M., Jin, M., The Utility of Radially and Ultrasonically Vibrated Dies in the Wire Drawing Process, *Journal of Materials Processing Technology*, Vol. 113, No. 1-3, 2001, pp. 81-86. DOI: 10.1016/S0924-0136(01)00635-5.
- [5] Murakawa, M., Jin, M., and Hayashi, M., Study on Semi Dry Wire Drawing Using Dlc Coated Dies, *Surface and Coatings Technology*, Vol. 177 –178, 2004, pp. 631–37. DOI: 10.1016/j.surfcoat.2003.08.057.
- [6] Huang, Z., Lucas, M., and Adams, M. J., Influence of Ultrasonics on Upsetting of a Model Paste, *Ultrasonics*, Vol. 40, No. 1-4, 2002, pp. 43–48. DOI: 10.1016/S0041-624X(02)00245-7.
- [7] Hayashi, M., Jin, M., and Thipprakmas, S., et al., Simulation of Ultrasonic-Vibration Drawing Using the Finite Element Method (Fem), *Journal of Materials Processing Technology*, Vol. 140, No. 1-3, 2003, pp. 30-35. DOI: 10.1016/s0924-0136(03)00699-x.
- [8] Mousavi, S., Akbari, A. A., Feizi, H., and Madoliat, R., Investigations on the Effects of Ultrasonic Vibrations in the Extrusion Process, *Journal of Materials Processing Technology*, Vol. 187-188, 2007, pp. 657-61. DOI: 10.1016/j.jmatprotec.2006.11.168.
- [9] Hung, J. C., Chiang, M. C., The Influence of Ultrasonic-Vibration on Double Backward-Extrusion of Aluminum Alloy, *Proceedings of the World Congress on Engineering; WCE*, London, U.K. 2009.
- [10] Pazand, K., Feizi, H., Using Artificial Neural Networks in Investigations on the Effects of Ultrasonic Vibrations on the Extrusion Process, *Applied Mechanics and Materials*, Vol. 52-54, 2011, pp. 103-08. DOI: 10.4028/www.scientific.net/AMM.52-54.103.
- [11] Abdullah, A., Paknejad, M., Dashti, S., Pak, A., and Beigi, A. M., Theoretical and Experimental Analyses of Ultrasonic-Assisted Indentation Forming of Tube, *Proceedings of the Institution of Mechanical Engineers, Part B: Journal of Engineering Manufacture*, Vol. 228, 2013, pp. 388-98. DOI: 10.1177/0954405413501502.
- [12] Simulia, D. S., *Abaqus 6.13 User's Manual*, Dassault Systems, Providence, 2013.
- [13] Hensel, A., Poluchin, P. I., Poluchin, and W. P., *Technologie Der Metallformung*: Wiley, 1991.
- [14] Bruni, C., Forcellese, A., Gabrielli, F., Simoncini, M., and Montelatici, L., Evaluation of Friction Coefficient in Tube Drawing Processes, *American Institute of Physics*, Vol. 907, 2007, pp. 552-57. DOI: 10.1063/1.2729571.
- [15] Siegert, K., Ulmer, J., Superimposing Ultrasonic Waves on the Dies in Tube and Wire Drawing, *Journal of Engineering Materials and Technology*, Vol. 123, No. 4, 2001, pp. 517. DOI: 10.1115/1.1397779.
- [16] Paknejad, M., Abdullah, A., and Azarhoushang, B., Effects of High Power Ultrasonic Vibration on Temperature Distribution of Workpiece in Dry Creep Feed up Grinding, *Ultrasonics Sonochemistry*, Vol. 39, 2017, pp. 392-402. DOI: <https://doi.org/10.1016/j.ultsonch.2017.04.029>.