



## **A New Method for ECG Denoising Using an Amalgamation of Adaptive and SG Filters**

**Ali Ghasemi<sup>1</sup>, Farzin Shama<sup>1\*</sup>, and Farshad Khosravi<sup>1</sup>**

<sup>1</sup>Electrical Engineering Department, Kermanshah Branch, Islamic Azad University, Kermanshah, Iran.

Received: 24-Jan-2022, Revised: 16-Feb-2022, Accepted: 19-Mar-2020.

### **Abstract**

Since ECG signals are non-stationary physiological, the recorded signals are corrupted by varied noise resources. So, they cannot be used to diagnose the illness. Separating signals from undesired noise such as motion artifact, power-line interference (PLI), and baseline wander (BW), is the main problem when analyzing medical data. These destructive effects are more severe, especially during the patient's physical activity. The objective of this research is to find effective ways to remove anomalies in the cardiac signal. In this paper, a method for noise reduction has been presented. In this regard, the noise reduction from heart signal, is improved using an amalgamation adaptive and Savitsky-Golay filter. Also, the presented ANC is modified by combining with a SG filter as suggested ECG noise cancelation (A-S) system. Findings demonstrate that the suggested A-S is more accurate and adequate compared to the previous methods.

**Keywords:** Adaptive filter, Electrocardiogram, Noise reduction, Savitzky-Golay filter (SG), Filter coefficient (Fc).

### **1. INTRODUCTION**

Electrocardiogram (ECG/ECG) signals take the measurements of heart activity and are used to recognize cardiac diseases. These diseases are recognizable by ocular evaluation or automatic diagnostic methods [1, 2]. A widely used noninvasive medical

method to measure heart activity is electrocardiography. This method records the electrical changes on the skin due to the electrical activity of the heart.

The ECG/EKG is an inexpensive approach to discover various types of arrhythmias, which can cause sudden deaths. Therefore, the ECG's sensitivity and specifications are vital [1]. Usually, sources of these noises are motion artifacts, power-

---

\*Corresponding Authors Email:  
f.shama@aut.ac.ir

line interference (PLI), Gaussian noise (GN), baseline wandering noise (BWN), interference in ECG attainment systems, and disturbances from other physiological signals such as electromagnetic noise, etc. [3]. Up to now, the problem of automated investigation of the electrocardiogram has developed in a separate path, branched into many specific issues related to different uses of the cardiovascular system. Separation of the desired signal versus noise is one of the principal problems in new electrocardiologic studies [4-6].

For exact diagnosis of specification features of electrocardiogram signals for beat segmentation and Electrocardiogram compaction, elimination of noises is essential. Researchers have put forward different noise reduction methods from EKG [2]. Conventionally, adaptive filtering-based techniques have been favored [4]. Later, significant research on wavelet transform-based noise-canceling ways is suggested [6,7].

In [6], A new model of AWT with identical correlation shrinkage function for EKG noise elimination has been presented. The presented algorithm has the adaptability of the adaptive wavelet thresholding (AWT) to different signals which is boosted by the automated election of the best wavelet selection method. But is a complex algorithm. Adaptive noise cancelers for the reduced noise from electrocardiogram were proposed by [8-11, 14-16]. The proposed technique does not work well for signals with a frequency range above 500 Hz. [12], proposed a new approach for extricating the fetal electrocardiogram from the maternal signal using  $v$  support vector regression.

Despite the reality that the path laid out works viably, there are still parcels of noise that haven't been explored. In [13], A new model of advanced State Kalman filtering based on one channel recordings for ECG Noise elimination has been suggested.

This paper includes a new method of combining adaptive and SG filters to reduce noise from the standard ECG signal. The reason for using the proposed method is the ability to efficiently eliminate noises in wide frequency bands, including high and low frequencies, which have never been used before together (in the investigated works of [3-16]) to obtain these abilities.

This approach presents a novel way of minimizing noise in reconstructed ECG. The various noises are dispensed with. The mixture of adaptive filters and Savitzky-Golay (SG) is used in the proposed ECG noise cancellation (A-S). The simulation findings will next be examined and compared to prior techniques.

## 2. ELECTROCARDIOGRAPH SIGNAL (ECG)

A typical electrocardiogram surge is shown in Fig.1 [1,4]. Based on this, we can classify this surge into four types: P, QRS, T, U.

A typical EKG signal that has low amplitudes, is shown in Fig.1. Even the R

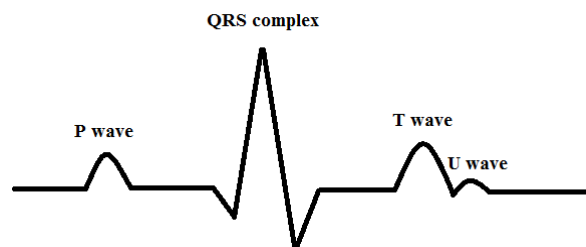

Fig. 1. A normal ECG wave [1,4].

peak has an amplitude of about 1-2.5 mV. It comprises four distinct entities: P, QRS, T, and U. The P wave represents atrial depolarization, and the atriums constrict immediately afterward. The QRS complex represents ventricular depolarization. The T wave represents ventricular repolarization [17-20]. The U wave showed papillary muscle repolarization. Changes in the heart's architecture impact the patterns of these four entities (including blood composition) [1].

## 2.1. Creation of the ECG Types

Forty people have been selected as a case study, and the mean specification has been computed and used to generate typical EKGs in software.

### 2.1.1. Generic ECGs

A normal ECG has been produced by MATLAB (R2012a) software, as shown in Fig.2. It is generated with a sampling rate of 4000-Hz. The heart rate is approximately 90 beats per minute (bpm), and the signal's amplitude is 0.9 mill volts.

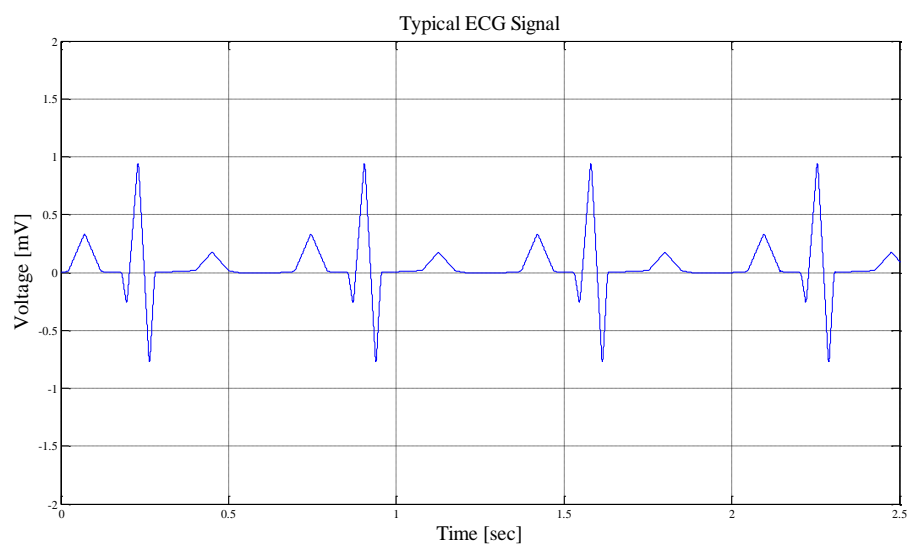

**Fig. 2. Simulated typical ECG signal.**

### 2.1.2. Noisy Combination of ECG

The electrocardiogram signal measured from the chest is commonly overcome by the noise. This distribution way has been performed by a linear FIR filter. Also, a Gaussian noise has been added to the signal shown in Fig3.; and unmatched in simulating any bandwidth of noise sources, within the measurement.

## 2.2 Noisy ECG Measured as a Reference Signal

From the chest, the electrocardiogram signal is obtained. Cancellation of the various noise is the aim of adaptive noise canceller in this function.

This noise-canceling system requires a reference signal produced from an electrocardiogram signal to do this. The ECG signal will have some increasable broadband noise. Measured noisy ECG signal is shown in Fig. 4, which has been considered as a reference signal.

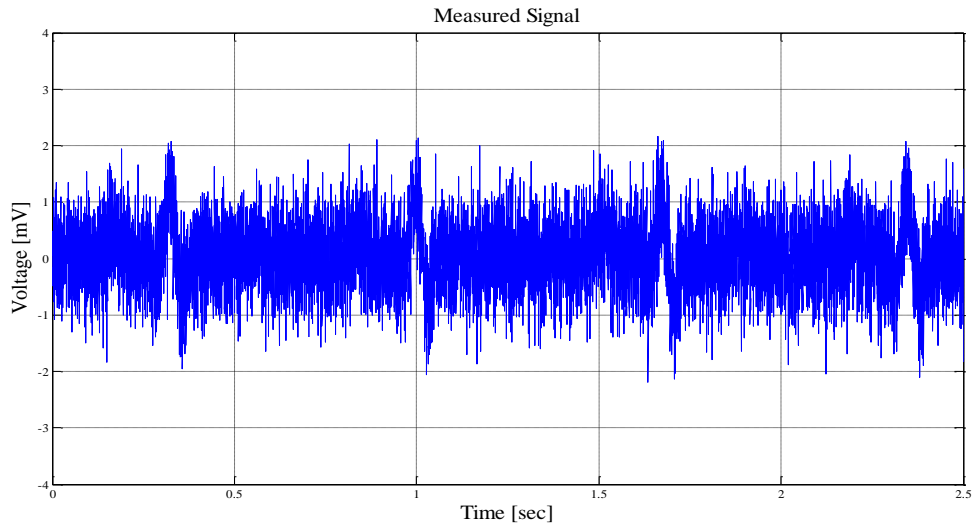

*Fig. 3. The measured ECG signal with noise.*

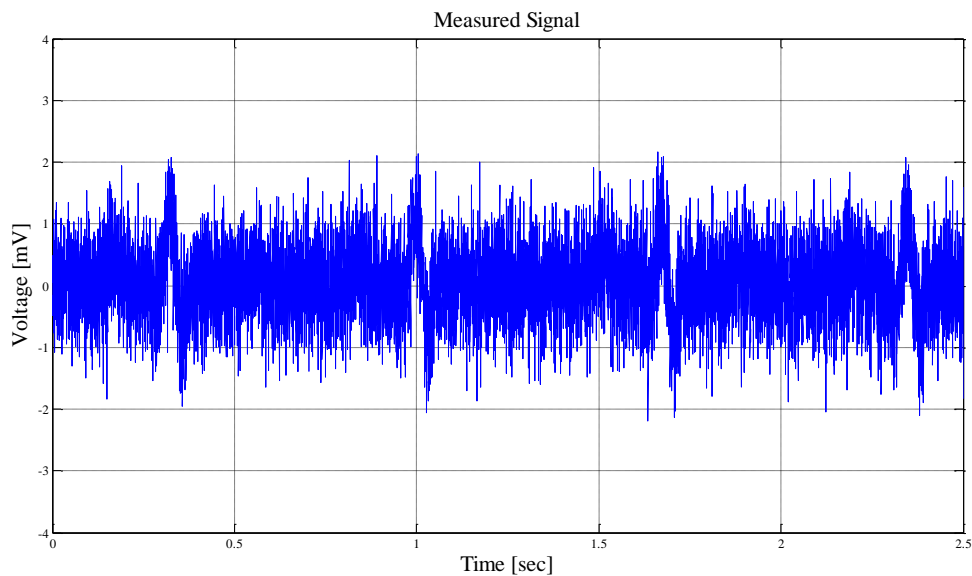

*Fig. 4. The measured noise signal (Reference signal).*

### 3. NOISE REDUCTION TECHNIQUE

The plan of the proposed A-S structure and noise cancellation (NC) structure is shown in Fig. 5. The suggested structure contains two filters (adaptive and SG filters). An adaptive filter predicts the noisy signal  $Y_1$ ,  $Y_2$  is the output of an adaptive filter that extracts the desired signal, and the final output ( $Y_3$ ) is the

same error signal that estimates optimized ECG signal. With these settings, the algorithm converges, and an admissible signal error will be obtained.

#### 3.1. Adaptive Filter

An adaptive filter is a digital filter that has a self-adapting specification. It can adjust its

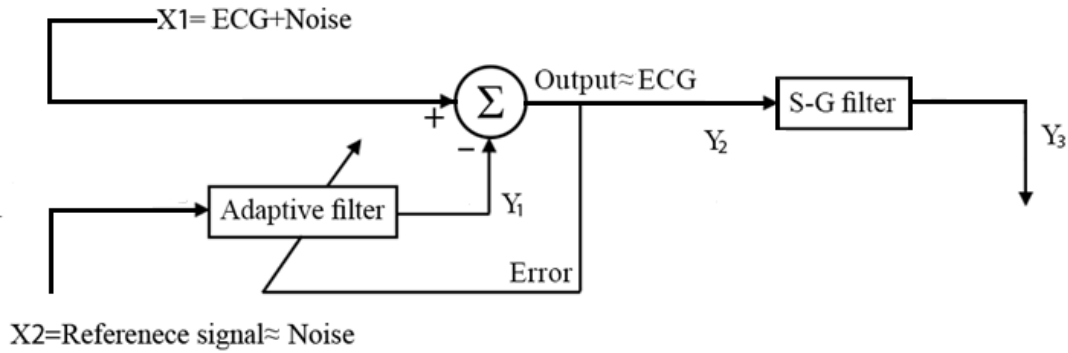

**Fig. 5. Proposed noise reduction from ECG signal and A-S system framework.**

FCs (Filter coefficients) spontaneously to adjust the input signal via a particular algorithm. Adaptive filters are commonly used for noise reduction from electrocardiogram signals as a conventional method [21-26]. In adaptive filters, there's no need to know the approximate foreordained noise and signal data [10]. In Fig. 10, the by and large structure of the utilized versatile filter is outlined. Based on this solution, the tips from a lead, or another biosensor, that is moderately safer to the commotion, are utilized. As a result, the filter input signals are a mixture of noise and signal, as well as the reference signal [4, 10-11].

The following formulae can be used to calculate the acquired error or  $t^{\text{th}}$  sample:

Equations should be right-numbered, such as:

$$y_{[t]} = S_{[t]} + N_{[t]} \quad (1)$$

$$\hat{N}_{[t]} = \sum_{i=0}^{n-1} w_{i[t]} x_{[i-t]} \quad (2)$$

$$e_t = y_{[t]} - \hat{N}_{[t]} = \hat{S}_{[t]} \quad (3)$$

Least mean square (LMS) is a commonly used error cancellation technique [10.11, 23,24]. Designers in this sector must consider a variety of parameters, including the pace of convergence, the number of epochs, and so on. It can be utilized in an adaptive filter as below:

$$w_{i+1[t]} = w_{i[t]} + 2\hat{S}e_t x_{[i-t]} \quad (4)$$

$$w_{i+1[t]} = \gamma w_{i[t]} + 2\gamma e_t x_{[i-t]} \quad (5)$$

$y_{[t]}$  is one of the filter inputs that is the amalgamation of favorable ( $S_{[t]}$ ) and Undesirable ( $N_{[t]}$ ) signal, next input is  $X_{[t]}$  which is the intensely subordinate to an undesirable signal.

$N_{[t]}$  is the yield of the versatile filter that can have an estimation of the commotion signal, and  $e_t$ , is error signal that can have a gauge of the signal that's desirable.  $W_{i[t]}$ , is filter ratio and  $W_{i+1[t]}$ , is overhaul the Fc.

The solidness and joining time of the least mean square calculation are decided by the merging coefficient of  $\gamma$  and the signal quality of the reference signal. The greatest esteem of  $\gamma$  for the solidness of the calculation, with the filter length and input signal control of ( $x_{[t]}$ , has a reversal proportion. A basic strategy for improving the joining rate of the least mean square calculation is the reliance of its solidness on the input signal quality. In normalized LMS algorithm, the weight adjustments connection is characterized as [15.23.24]:

$$w_{i+1[t]} = w_{i[t]} + \gamma_t x_t e_t \quad (6)$$

The merging ratio of  $\gamma_t$  may be a time variable parameter and calculated as follows [23.24]:

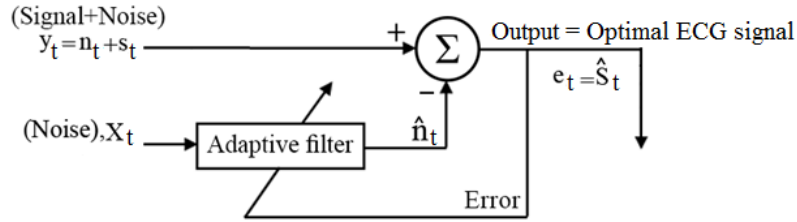

Fig. 6. The general structure of the adaptive filter.

$$\gamma_t = \frac{\alpha}{\hat{L}_x(t)} = \frac{\alpha}{\mathbf{x}_t^T \mathbf{x}_t}; \quad 0 < \alpha < 2 \quad (7)$$

$L(t)$  could be a power evaluation of  $X_t$ , and alpha could be a consistent number. For a commonsense execution of the NLMS calculation, two following considerations are more often not considered:

- A.  $L_x(0)$  is the most excellent starting approximation for the input signal control.
- B. When the  $L_x(0)$  is nil or about nil,  $\gamma_t$  calculated by [23.24]:

$$\gamma_t = \frac{\alpha}{\mu + \hat{L}_x(t)} \quad (8)$$

where  $\gamma$  may be a positive steady value, which anticipates the precariousness within the algorithm making via the nonappearance from an input signal or a little  $L_x(0)$ .

In this model, the measured signal includes two signals, the required and the intervention signals. The reason for measuring the signal is to dispose of the noise signal employing a reference signal, which is emphatically subordinate to the noise signal. So, the noise is reliably isolated from the desired signal. As examined already, the electrocardiogram from electrodes put on the chest is touchy to noise, such as the action of the muscles.

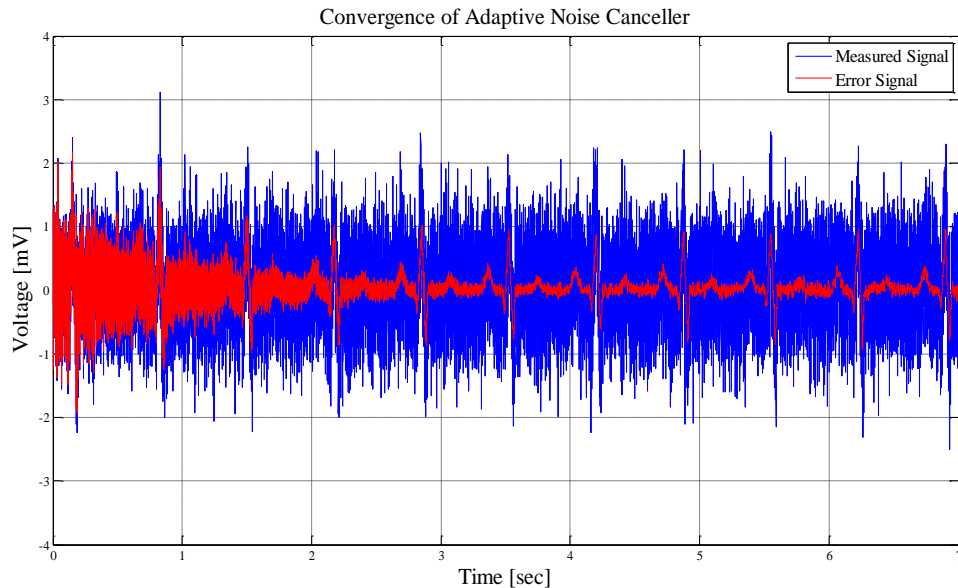

Fig. 7. After 2.1 seconds, the suggested A-S system with LMS method and  $Fc = 16$  and  $\gamma = 0.0007$  achieved convergence and error margins in the output.

## 4. RESULTS AND DISCUSSION

The simulation results after modifying the parameters and techniques are shown in Figures 7 to 10. The best performance is achieved by the proposed ANC system, which employs an amalgamation of the SG filter and (LMS) method. It has the values of

the parameters of  $S/N_b = -8.8125$  dB,  $S/N_a = 12.7954$  dB, and  $S/N$  increase of 21.6079 dB.

### 4.1. SG Filter

A Savitzky–Golay filter could be an advanced filter that can be connected to a collection of computerized information that

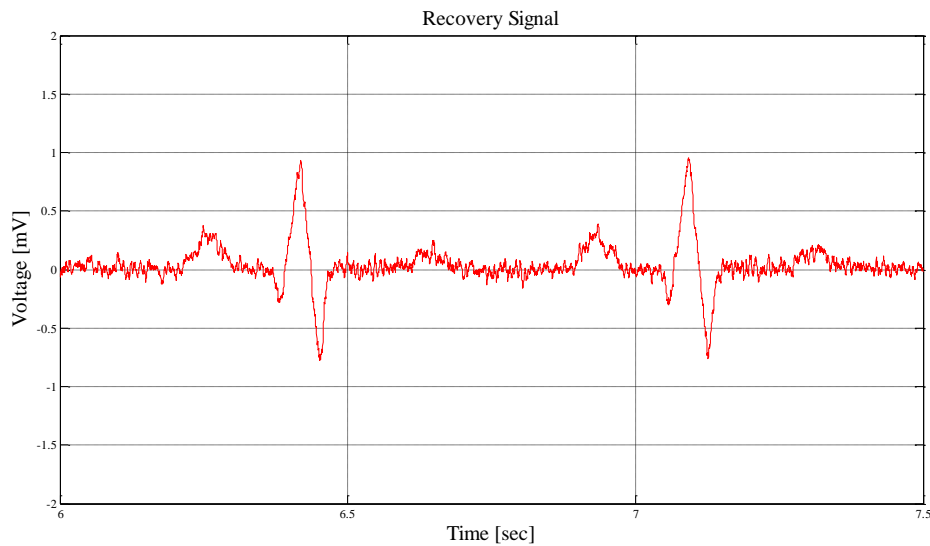

**Fig. 8. Recovery of ECG signal, with LMS method, with  $F_c = 16$  and  $\tau = 0.0007$ .**

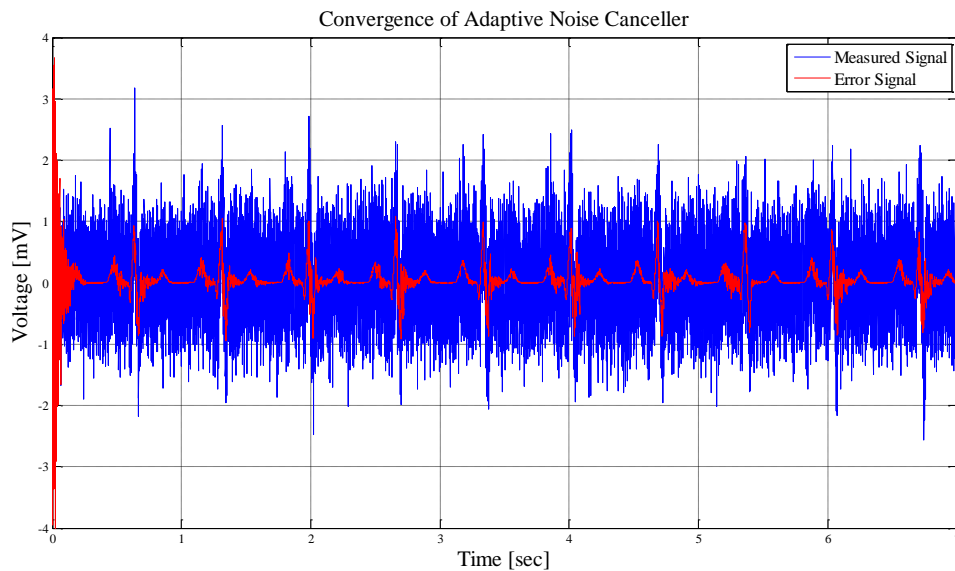

**Fig. 9. After 0.17 seconds, the suggested A-S system with NLMS method and  $F_c = 16$  and  $\tau = 0.08$  achieved convergence and error margins in the output.**

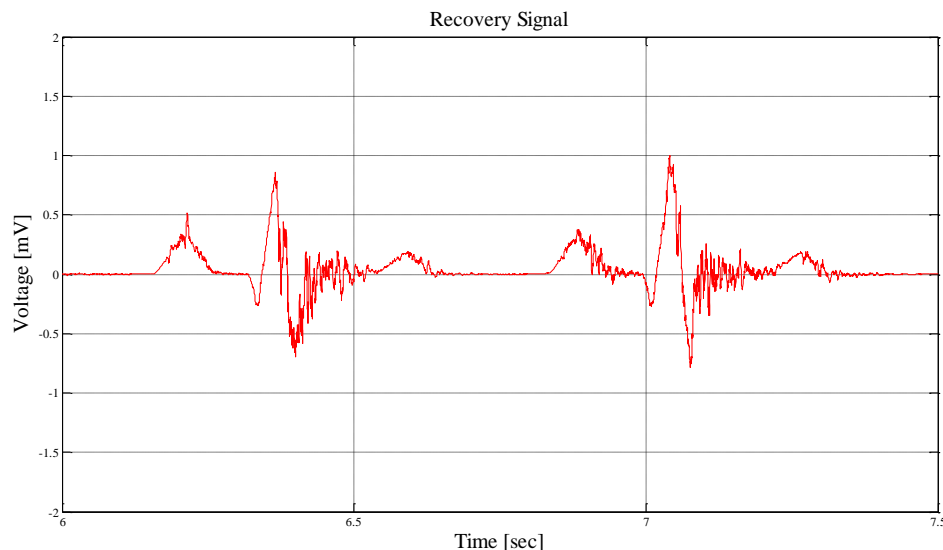

**Fig. 10. Recovery of ECG signal, with NLMS method, with  $F_c = 16$  and  $\gamma = 0.08$ .**

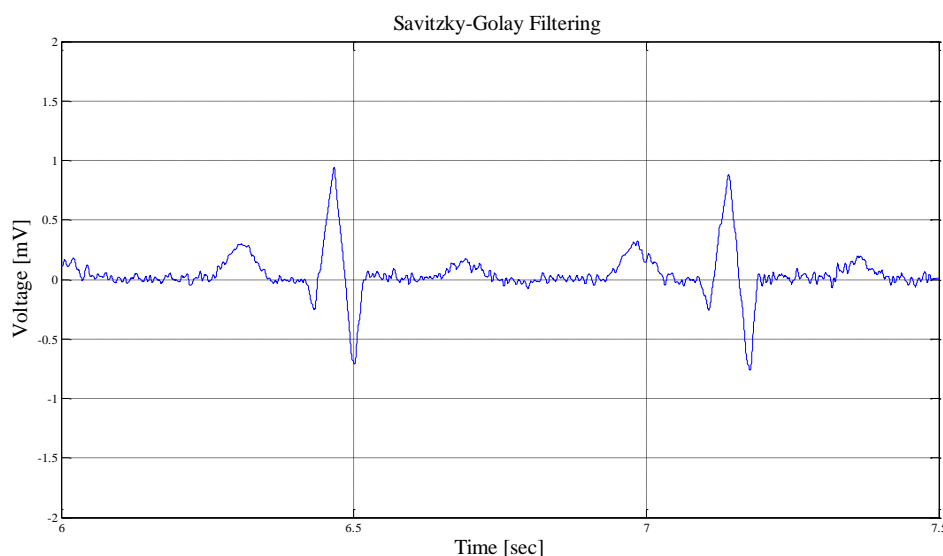

**Fig. 11. Suggested A-S system recovers the ECG signal using an amalgamation of SG filter and LMS method with an  $F_c = 16$  and  $\gamma = 0.0007$ .**

focuses on smoothing the data, that's, to extend the accuracy of the information Unchanged the signal propensity. This is often accomplished, in a familiar concept as convolution, by appropriate progressivist sub-sets of adjoining information focuses with a low degree polynomial via the strategy of linear slightest squares. When the information focuses are similarly dispersed, an explanatory arrangement to the least-

squares conditions can be found, within the shape of a single set of "convolution coefficients" that can be connected to all information sub-sets, to provide gauges of the smoothed signal, at the center point of any sub-set. The strategy, based on built-up numerical ways, [27] was made famous by Savitzky and Golay, who distributed tables of convolution coefficients for different polynomials and sub-set sizes in 1964



[28,29]. A few blunders within the schedules have been reformed. The strategy has been amplified for the order of 2 and 3-dimensional data.

The information includes a collection of focuses  $\{x_i, y_i\}$ ,  $i = 1, \dots, m$ , where  $x$  is an autonomous varying and  $y_i$  is a watched esteem. They are ordered with a collection of  $n$  convolution coefficients,  $C_j$ , concurring with the statement [30-32].

$$Y_i = \sum_{j=(1-n)/2}^{(n-1)/2} C_j y_{i+j} \quad (9)$$

$$(n-1)/2 \leq i \leq m - (n-1)/2$$

#### 4.1.1. Noise Cancellation of ECG Signals Using the SG Filter

The generated ECG signal and the observed noisy cardiac signal filtered by the SG filter employing different noises are shown in Figures 11 and 14.

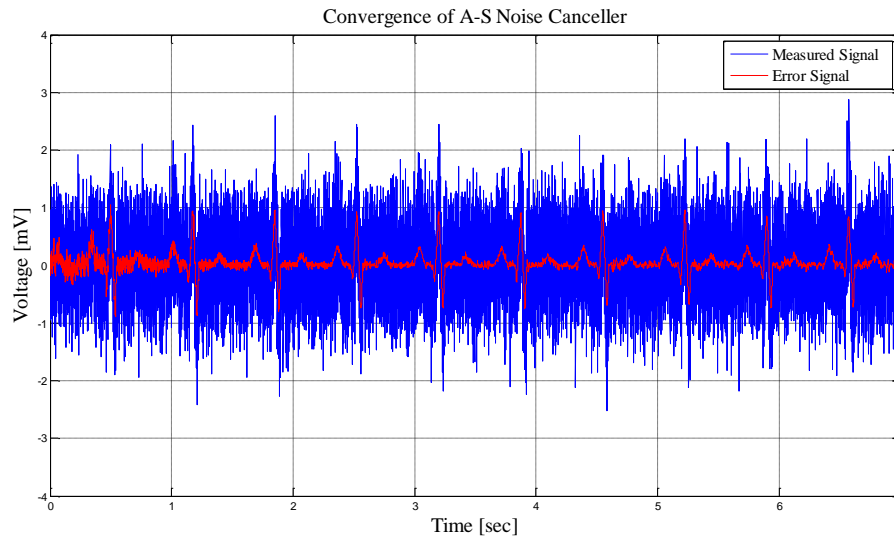

**Fig. 12.** Output convergence and error margins using the proposed A-S system, which uses an amalgamation of SG filter and LMS method with an  $F_c = 16$  and  $\tau = 0.0007$  after 0.47 seconds.

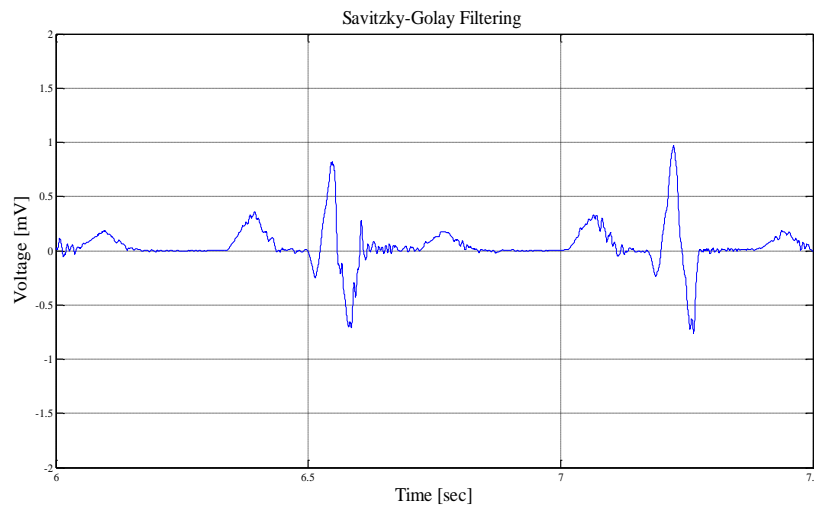

**Fig. 13.** Suggested A-S system recovers the ECG signal using an amalgamation of SG filter and NLMS method with an  $F_c = 16$  and  $\tau = 0.08$ .

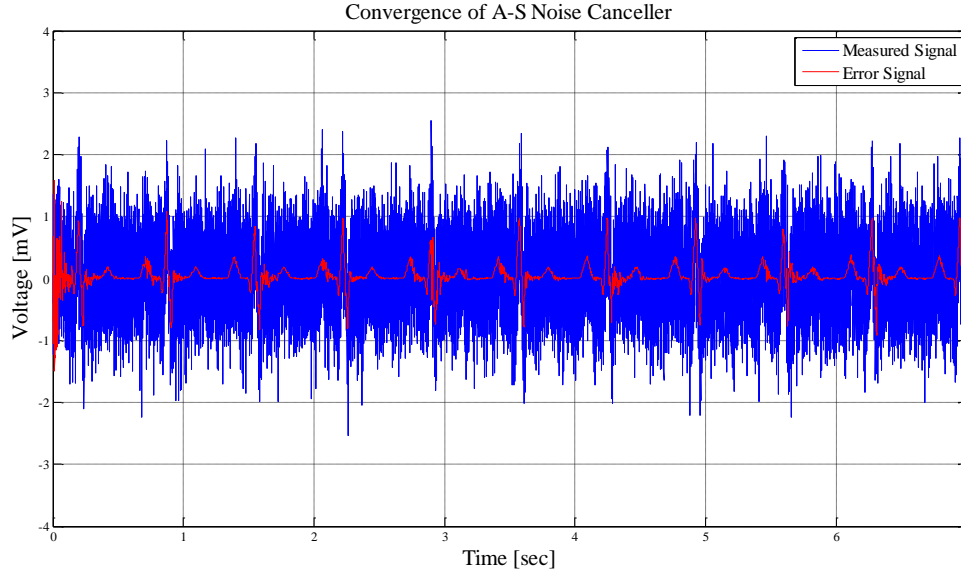

**Fig. 14. Output convergence and error margins using the proposed A-S system, which uses an amalgamation of SG filter and NLMS method with an  $F_c = 16$  and  $\gamma = 0.08$  after 0.15 seconds.**

The findings are summarized in Table 1. When compared to other techniques, combining the SG filter with the NLMS or LMS algorithm results in a significantly faster rate of error rate reduction and high S/N enhancement performance.

The following parameters are utilized in tables:

The S/N before filtering ( $S/N_b$ ) is computed as:

$$S/N_b = 10 \log_{10} \frac{\sum_n ECG}{\sum_n Noise} \quad (10)$$

The S/N after filtering ( $S/N_a$ ) is defined as:

$$S/N_a = 10 \log_{10} \frac{\sum_n \widetilde{ECG}}{\sum_n ECG - \widetilde{ECG}} \quad (11)$$

The mean square error is calculated as:

$$MSE = \frac{\sum_{n=1}^N (\widetilde{ECG} - ECG)^2}{N} \quad (12)$$

where ECG and  $\widetilde{ECG}$  are the desirable ECG

signal and the extracted ECG signals, respectively. Table 1 shows the retrieved parameters for  $S/N_b = -8.8125$  dB.

The gotten comes about to appear that an amalgamation of SG filter and LMS calculation with an  $F_c = 16$  and  $\gamma = 0.0007$  includes a superior  $S/N_a$  and excellent performance in ECG denoising compared to other tasks due to normal  $S/N_b$  in the range of -15 dB to -2 dB. Also, taking into account the price of  $S/N_b = -8.8125$  dB sometime recently filtered or  $S/N = 12.7954$  dB after filtering, the progress of the 21.6079 dB S/N has been obtained. Table 2 shows a comparison of several published studies with the suggested technique.

To investigate this table, it can be concluded that:

By utilizing versatile neuro-fuzzy induction, [3] offers a methodology for upgrading the recuperated ECG, while the improved heart signal is low. In digital signals, recommended noise reduction techniques work well; but, in ECG signals, the corners of the signal cannot be retrieved

**Table 1. (a) shows the outcomes of the simulation only using the adaptive filter (b) after amalgamation an adaptive and SG filters.**

<i>(a)</i>				
The Algorithm used	MSE	The amount of time required for convergence and the remaining error in the output in (s)		S/N (dB) after filtering
LMS with an Fc = 16 and $\gamma = 0.0007$ .	0.1827	2.1		4.1470
NLMS with an Fc = 16 and $\gamma = 0.08$ .	0.0611	0.17		6.1676

<i>(b)</i>				
The Algorithm used	MSE	The amount of time required for convergence and the remaining error in the output in (s)	S/N (dB) After filtering	S/N Improvement (dB)
LMS with an Fc = 16 and $\gamma = 0.0007$ .	0.0161	0.47	12.7954	8.6484
NLMS with an Fc = 16 and $\gamma = 0.08$ .	0.0446	0.15	7.2292	1.0616

**Table 2. shows a comparison of a few published works.**

Ref	[3]	[4]	[5]	[14]	[19]	Proposed method
<b>Maximum q-S/N (dB)</b>	7.5288	17.4775	7.9776	12.6809	0.9629	<b>18.785</b>

using this method. In [4,5,14], the adaptive noise cancelers have been presented for noise canceling. The presented technique acts well only for the signals with a frequency range below 500 Hz. In [19], multidimensional ICA (MICA) methods have been applied for ECG noise cancelation. The presented methods have a good performance, but various noises have not been used to investigate. Therefore, as shown in Table 2, the proposed method leads to the best Maximum q-S/N (dB) parameter among the discussed works.

## 5. CONCLUSION

For assessing the disease's potential, the ability to obtain an accurate cardiac signal is essential. Some noise reduction strategies can help you improve your ECG. This study presents a new approach for canceling ECG noise that incorporates SG and adaptive filters. The results demonstrate that a decent S/N may be attained compared to traditional techniques (NLMS or LMS algorithm). This algorithm may be a suitable fit for ECG monitoring because of its ability to minimize fluctuating noises from several sources. The

S/N was improved by 21.6079 dB using the suggested technique.

## REFERENCES

- [1] Andreoli, Carpenter, Griggs, Benjamin, "Cecil essentials of medicine", 2007, 7th ed. <https://www.textbooks.com/Cecil-Essentials-of-Medicine-7th-Edition/9781416029335/Thomas-E-Andreoli-Charles-CJ-Carpenter-and-Robert-C-Griggs.php>
- [2] Shweta Jain, Varun Bajaj, Anil Kumar, "Effective de-noising of ECG by optimized adaptive thresholding on noisy modes" IET Science, Measurement & Technology, Vol. 12 Iss. 5, pp. 640-644, April (2018), DOI: 10.1049/iet-smt.2017.0203.
- [3] Hajar Ahmadi, Babak Mohammadzadeh Asl, "Fetal ECG extraction via Type-2 adaptive neuro-fuzzy inference systems", Elsevier, Computer Methods and Programs in Biomedicine, Vol. 142, February (2017), DOI :<https://doi.org/10.1016/j.cmpb.2017.02.009>.
- [4] Bernard Widrow, Robert C. Goodlin, et al., "Adaptive Noise Canceling: Principles and Applications", Proceedings of the IEEE, vol. 63, pp. 1692-1716, Dec (1975), DOI: 10.1109/PROC.1975.10036
- [5] Qiusheng Wang, Xiaolan Gu, Jinyong Lin, "Adaptive notch filter design under multiple identical bandwidths", Elsevier, Int. J. Electron. Commun. (AEU), Vol. 82, December (2017), DOI:<https://doi.org/10.1016/j.aeue.2017.08.054>.
- [6] Manu Thomas, Manab Kr Das, Samit Ari, "Automatic ECG arrhythmia classification using dual tree complex wavelet based features", Elsevier, Int. J. Electron. Commun. (AEU), Vol 69, Issue 4, April (2015) DOI: <https://doi.org/10.1016/j.aeue.2014.12.013>.
- [7] Ranjeet Kumar, A. Kumar, G.K. Singh, "Electrocardiogram Signal Compression Based on Singular Value Decomposition (SVD) and Adaptive Scanning Wavelet Difference Reduction (ASWDR) Technique", Elsevier, Elsevier, Int. J. Electron. Commun. (AEU), Vol 69, Issue 12, December (2015), DOI: <https://doi.org/10.1016/j.aeue.2015.09.011>.
- [8] Yaping Ma, Yegui Xiao, Guo Wei, Jinwei Sun, "Foetal ECG extraction using non-linear adaptive noise canceler with multiple primary channels", IET Signal Process., Vol. 12 Iss. 2, (2018), DOI: <https://doi.org/10.1016/j.aeue.2014.12.013>.
- [9] Sara Lilia Lima-Herrera, Carlos Alvarado-Serrano, Pablo Rogelio Hernandez-Rodriguez, "Fetal ECG extraction based on Adaptive Filters and Wavelet Transform: Validation and Application in Fetal Heart Rate Variability Analysis", IEEE(CCE), (2016), DOI: 10.1109 /ICEEE.2016.7751243.
- [10] Yushun Gong, Peng Gao, Liang Wei, Chenxi Dai, Lei Zhang, and Yongqin Li, "An Enhanced Adaptive Filtering Method for suppressing Cardiopulmonary Resuscitation Artifact", IEEE Transaction on Biomedical Engineering, Vol. 64, No.

- 2, February (2017), DOI: 10.1109/TBME.2016.2564642.
- [11] Zhang N, Zhang J, Li H, Mumini OO, Samuel OW, Ivanov K, Wang L, "A Novel Technique for Fetal ECG Extraction Using Single-Channel Abdominal Recording", NCBI, Feb (2017), DOI: 10.3390/s17030457.
- [12] Liang Han, Xiu-juan Pu, Xiao-jun Chen, "Method of fetal electrocardiogram extraction based on v-support vector regression", IEEE, IET Signal Processing, Vol 9, Issue 5, June (2015), DOI: 10.1049/iet-spr.2013.0201.
- [13] Mohammad Niknazar, Bertrand Rivet, and Christian Jutten, " Fetal ECG Extraction by Extended State Kalman Filtering Based on Single-Channel Recordings", IEEE Transactions on Biomedical Engineering, Vol. 60, No. 5, May (2013), DOI: 10.1109/ TBME.2012.2234456.
- [14] Ranjit Singh, Amandeep Singh, Jaspreet Kaur, " Adaptive Filter Design for Extraction of Fetus ECG Signal", Springer, September (2015), DOI: [https://doi.org/10.1007/978-81-322-2523-2\\_10](https://doi.org/10.1007/978-81-322-2523-2_10).
- [15] Seyed Reza Aali, Mohammad Reza Besmi, Mohammad Hosein Kazemi, "Smart VRPNLMS algorithm for estimation of power system frequency", COMPEL - The international journal for computation and mathematics in electrical and electronic engineering, 02 November (2018), **Error! Hyperlink reference not valid.** COMPEL-06-2018-0263.
- [16] Kai Xiong, Liangdong Liu, "Design of parallel adaptive extended Kalman filter for online estimation of noise covariance", Aircraft Engineering and Aerospace Technology, 05 December (2018) <https://doi.org/10.1108/AEAT-01-2018-0066>.
- [17] Hoai Linh Tran and Van Nam Pham, "A hardware implementation of intelligent ECG classifier", The International Journal for Computation and Mathematics in Electrical and Electronic Engineering, Vol. 34 No. 3, (2015), DOI 10.1108/COMPEL-05-2014-0119.
- [18] Shweta Jain, Varun Bajaj, Anil Kumar, "Effective de-noising of ECG by optimized adaptive thresholding on noisy modes" IET Science, Measurement & Technology, Vol. 12 Iss. 5, pp. 640-644, April (2018), DOI: 10.1049/iet-smt.2017.0203.
- [19] J. L. Camargo-Olivares, R. Martin-Clemente, S. Hornillo-Mellado, M. M. Elena, and I. Roman, " The Maternal Abdominal ECG as Input to MICA in the Fetal ECG Extraction Problem", IEEE Signal Processing Letters, Vol. 18, No. 3, March (2011), DOI: <https://doi.org/10.1109/LSP.2011.2104415>.
- [20] Fatemeh Haghdoost Vahid Mottaghitalab Akbar Khodaparast Haghi, "Comfortable textile-based electrode for wearable electrocardiogram", Sensor Review, Vol. 35 Iss 1 pp. 20 – 29, 30 January (2016), <http://dx.doi.org/10.1108/SR-08-2013-719>.

- [21] Dragos-Daniel taralunga, georgeta-Mihaela unguoreanu, Ilinca gussi, Rodica strungaru, and Werner wolf, "Fetal ECG extraction from abdominal signals: A review on suppression of fundamental power line interference component and its harmonics", Hindawi, Computational and mathematical methods in medicine, Volume 2014, Article ID 239060, 15 pages **Error! Hyperlink reference not valid.**
- [22] Rajvansh Sehamby, Buta Singh, "Noise Cancelation using Adaptive Filtering in ECG Signals: Application to Biotelemetry", International Journal of Bio-Science and Bio-Technology Vol.8, No. 2 (2016), <http://dx.doi.org/10.14257/ijbsbt.2016.8.2.22>.
- [23] Eweda, Neil J. Bershada, and Jose C. M. Bermudez, "Stochastic Analysis of the LMS and NLMS Algorithms for Cyclostationary White Gaussian and Non-Gaussian Inputs", IEEE Transactions on Signal Processing, Volume: 66, Issue: 18, Sept (2018), DOI: 10.1109/TSP.2018.2860552.
- [24] Gholamreza Bakhshi and Kamal Shahtalebi, "Role of the NLMS Algorithm in Direction of Arrival Estimation for Antenna Arrays", IEEE Communications Letters, Volume: 22, Issue: 4, April (2018), DOI: 10.1109/LCOMM.2017.2760253.
- [25] K.V.L.Narayana, D. A. Bhujanga Rao, "Noise removal using adaptive noise canceling, analysis of ECG using MATLAB", International Journal of Engineering Science and Technology (IJEST), Visakha- patnam -17, Andhrapradesh, India, Vol. 3 No. 4 Apr (2011), <http://www.ijest.info/docs/IJEST11-03-04-108.pdf>.
- [26] Daulen N. Koishybaev, Maulenbek T. Abdulkhairov, Erkebulan S. Kunesbekov, Aidana S. Kyzdarbekova, "Adaptive noise cancellation in ECG signal", 2017 International Conference "Quality Management, Transport and Information Security, Information Technologies", (IT&QM&IS), 2017.
- [27] A. John, J. Sadasivan, Ch S. Seelamantula, "Adaptive Savitzky-Golay Filtering in Non-Gaussian Noise", IEEE Transactions on Signal Processing, Volume: 69, August (2021), <https://doi.org/10.1109/TSP.2021.3106450>.
- [28] Schafer, Ronald W, "What is a Savitzky-Golay filter.", IEEE Signal processing magazine 28, no. 4 (2011): 111-117. DOI: 10.1109/MSP.2011.941097.
- [29] Ashish Birle, Suyog Malviya, Deepak Mittal, "Noise removal in ECG signal using Savitzky - Golay filter", (IJARECE), Volume 4, Issue 5, May (2015), ISSN: 2278 – 909X.
- [30] Howard J. Wayt and Taufiqar R. Khan, "Integrated Savitzky-Golay filter from inverse Taylor series approach", IEEE, Clemson University, 2007, DOI: 10.1109/ICDSP.2007.4288597.
- [31] Jianwen Luo, Kui Ying, Ping He, Jing Bai, "Properties of Savitzky-Golay digital differentiators", Elsevier, October 2004, DOI: 10.1016/j.dsp.2004.09.008.

- 
- [32] Chong Wang, Zhaoyu Wang, Jianhui Wang, Dongbo Zhao, "SVM-Based parameter identification for composite ZIP and electronic load modeling", *IEEE Transactions on Power Systems*, Volume: 34, Issue: 1, Jan. (2019), DOI: <https://doi.org/10.1109/TPWRS.2018.2865966>.